



DEGRENNE

PARIS

Since 1948
70 years of Excellence



SOMMAIRE

CONTENTS - RESUMEN

LA VAISSELLE – TABLEWARE – VAJILLA

46-47	API
28-35	BAHIA
20-23	BORÉAL
24-27	BORÉAL SATIN
12-13	COLLECTION L
14-15	COLLECTION L FRAGMENT
18-19	GOURMET BLEU
16-17	GRAPHIQUE
42-47	MODULO
36-41	MODULO NATURE
48-49	NEW MOON
50-51	SMOOS

LA CAFETERIE – TEA TIME – TE CAFE

62-63	BAHIA
60-61	COLLECTION L
60-61	COLLECTION L FRAGMENT
64-65	MODULO NATURE
60-61	NEWPORT
56-57	SALAM
58-59	SALAM THÉ
62-63	SMOOS

LES COUVERTS – FLATWARE – CUBIERTOS

106-107	ABSOLU
98-99	ALOA
90-91	AQUATIC
92-93	ASTRÉE CISELÉ
94-95	ASTRÉE MIROIR
120-121	BLOIS
122-123	CONFIDENCE
70-71	COUTEAUX STEAK
108-109	FLORENCIA
82-83	GUEST CUIVRE
84-85	GUEST MIROIR
80-81	GUEST STAR
86-87	GUEST VINTAGE
118-119	LUTÈCE
110-111	MARQUISE
124-125	MIKADO
126-127	MIKADO VINTAGE
112-113	MILADY
96-97	MIRAGE
103	PETIT GOURMET
102	PIÈCES COMPLÉMENTAIRES
100-101	QUARTZ
78-79	SERENITY
88-89	SOLSTICE
114-115	SQUADRO
116-117	VERLAINE
128-129	VIEUX PARIS SATINE
74-75	XY BLACK MIROIR
76-77	XY MIROIR

LA PLATERIE – HOLLOWARE – ORFEBRERÍA

142-143	ACCESSOIRES PLATERIE
134-135	NEWPORT CUBIQUE
132-133	NEWPORT PLATEAUX
136-137	NEWPORT TABLE
138-139	NEWPORT CAFÉTERIE
140-141	NEWPORT BAR

LA VERRERIE – GLASSWARE – CRISTALERIA

166-167	ALLEGRO
162-163	ANYTIME
168-169	BILBAO
160-161	CARAFES
164-165	COSMOPOLITAIN
146-147	DANDY
160-161	DÉCANTEURS
166-167	DOLCE
156-157	DOMAINE
150-151	GALATEE
164-165	LOOP
168-169	MAMBO
158-159	MONTMARTRE
148-149	MUSE
152-155	ORIGINE
162-163	VERRINES

LE BUFFET – BUFFET – BUFET

188-189	BUFFET EVENTO
172-175	CHAFING DISH
176-179	MODULES FROIDS
180-181	URNE À JUS DE FRUITS
182-183	DISTRIBUTEUR À CÉRÉALES
184-185	SUPPORT FIL RECTANGULAIRE
186-187	SUPPORT FIL ROND
192-193	PIECES DETACHEES
190-191	PLAN

LA CUISINE – KITCHENWARE – COCINA

201	IDEAL ALU
198-199	IDEAL FORGE
200	IDEAL FORGE OLIVIER
202-203	LECONOME
204-205	NEWCOOK EXPERT
206-207	NEWCOOK

LE SAVOIR-FAIRE DEGRENNE

- Une grande Maison Française, **fondée en 1948**
- Une **excellence reconnue par l'Etat** avec le label d'« **Entreprise du Patrimoine Vivant** »
- Un **savoir-faire complet** : Vaisselle, Cafétérie, Couverts, Verrerie, Platerie, Buffet et Cuisine
- Une marque leader des arts de la table : **+ 35 millions de pièces vendues chaque année**
- Une gamme large de produits : **+ 1 300 références actives** au catalogue Gastronomie
- Une référence internationale des arts de la table, **présente dans +85 pays**
- Des **offres produits multi-réseaux** : CHR, Retail, Industrie
- Une **qualité plébiscitée par les plus grands noms** de la restauration
- Le **fournisseur référent des chaînes d'hôtels internationales** les plus renommées
- Des **partenaires distributeurs aux quatre coins du monde**

DEGRENNE KNOW-HOW

- A great French House, **founded in 1948**
- A **recognized excellence by the State** with the “**Entreprise du Patrimoine Vivant**” label
- A **complete know-how**: Tableware, Tea time, Flatware, Glassware, Holloware, Buffet and Kitchenware
- A leading brand of tableware: **+35 million pieces sold each year**
- A wide range of products: **+1 300 active references** in Gastronomy catalog
- An international reference, distributed in **+85 countries**
- **Multi-channel product offers**: HORECA, Retail, Industry
- A **quality acclaimed by the biggest names** in catering
- Corporate supplier of the **leading international hotel chains**
- **Distribution partners in most countries**

EL SABER HACER DEGRENNE

- Una gran Casa Francesa, **fundada en 1948**
- Una **excelencia reconocida por el Estado** con la marca «**Entreprise du Patrimoine Vivant**»
- **Un completo saber hacer**: Vajilla, Té Café, Cubiertos, Cristalería, Orfebrería, Bufet y Cocina
- Una marca líder en Arte de Mesa: **+35 millones de piezas vendidas cada año**
- Una amplia gama de productos: **+1 300 referencias activas** en el catálogo de Gastronomía
- Una referencia internacional, **distribuida en +85 países**
- **Ofertas de productos multicanal**: HORECA, Retail, Industry
- Una **calidad aclamada por los más importantes** nombres de la restauración
- Proveedor corporativo de **las principales cadenas hoteleras internacionales**
- **Socios de distribución en la mayoría de los países**



Entreprise
du Patrimoine
Vivant

L'excellence
des savoir-faire
français

DEGRENNE WORLDWIDE

4
SITES DE PRODUCTION
PRODUCTION SITES
PLANTAS DE PRODUCCION

2
SHOWROOMS
PARIS
NEW YORK

DEGRENNE
PARIS
VIRE/FRANCE
FLATWARE-HOLLOWARE
COOKWARE

● VIRE ● PARIS

MADE IN FRANCE

● THIERS
● LIMOGES

DEGRENNE
PARIS
PARIS/FRANCE
SHOWROOM

DEGRENNE
PARIS
LIMOGES/FRANCE
TABLEWARE

DEGRENNE
PARIS
THIERS/FRANCE
CUTLERY

DEGRENNE
PARIS
ALFOLD/HUNGARY
TABLEWARE

HUNGARY ●

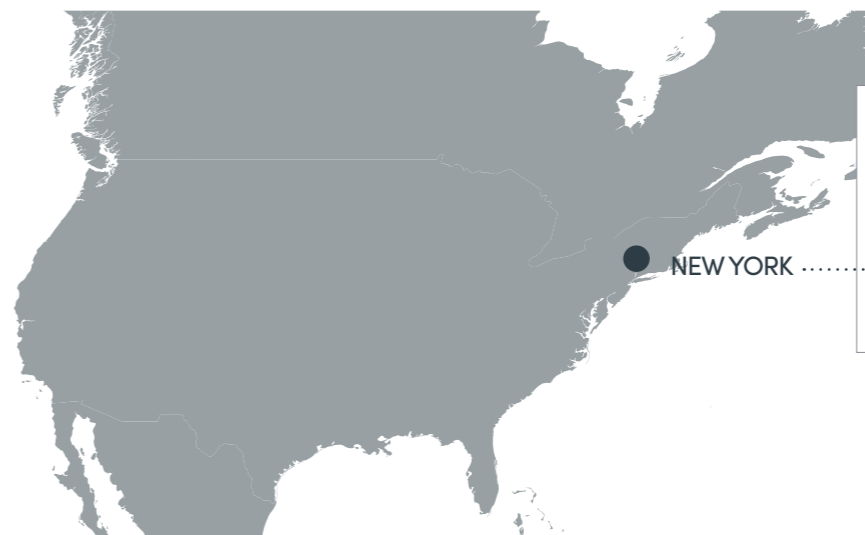

DEGRENNE
PARIS
● NEW YORK
NEW YORK/USA
41 MADISON
SHOWROOM



NOS PARTENAIRES OUR PARTNERS - NUESTROS SOCIOS

LES CUISINIERS DE LA RÉPUBLIQUE FRANÇAISE



LES MAÎTRES CUISINIERS DE FRANCE



ACADÉMIE CULINAIRE DE FRANCE



CLUB DES DIRECTEURS DE
LA RESTAURATION ET D'EXPLOITATION



LES TOQUES BLANCHES LYONNAISES



CHEFS D'ALSACE



COUPE GEORGES BAPTISTE



FERRANDI
L'ÉCOLE FRANÇAISE DE GASTRONOMIE



FERRIÈRES
ÉCOLE DE L'HOTELLERIE



INSTITUT PAUL BOCUSE
ÉCOLE DE MANAGEMENT HOTELIERIE RESTAURATION



BEST
ÉCOLE DE BORDEAUX



AFLYHT
ASSOCIATION FRANCAISE DES LYCÉES D'HOTELLERIE ET DE TOURISME



ACCOR HOTELS

SOFITEL. MGALLERY.
PULLMAN. NOVOTEL.
MERCURE. IBIS.
FAIRMONT. RAFFLES.
SWISSOTEL.

FOUR SEASONS

MARRIOTT/STARWOOD

JW MARRIOTT.
RITZ CARLTON.
MARRIOTT.WESTIN.
W HOTELS. MERIDIEN.
SHERATON ST REGIS.

HILTON WORLDWIDE

WALDORF ASTORIA.
CONRAD. HILTON.
DOUBLETREE.

LOUVRE HOTELS

CAMPANILE.
GOLDEN TULIP.
KYRIAD.

LA VAISSELLE - TABLEWARE - VAJILLA

DEGRENNE travaille les formes et les matières en portant une attention particulière aux attentes des chefs, tant esthétiques que dans l'usage. Pour faire de la table un moment dédié aux plaisirs gastronomiques, du plus simple au plus élaboré, DEGRENNE imagine des collections uniques qui incarnent l'excellence et qui peuvent être associées entre elles. En jouant sur les combinaisons, les contrastes, les formes, les couleurs et les matières, chaque mets trouve harmonieusement sa place à table, avec élégance et sobriété. Matières nobles, lignes épurées, épousez tous les savoir-faire DEGRENNE lorsque vous dressez votre table.

DEGRENNE develops shapes and materials, while paying careful attention to chefs' practical usage and aesthetic requirements. DEGRENNE designs unique collections that are the very embodiment of excellence and can also be combined, in order to make dining a moment of culinary pleasure, from the simplest to the most elaborate pleasures. Each dish harmoniously finds its rightful place on the table, with simplicity and elegance, thanks to the combinations, contrasts, shapes, colours and materials employed by Degrenne. Capitalize on DEGRENNE'S extensive expertise when setting your table : we offer sleek lines and the finest materials.

DEGRENNE trabaja las formas y los materiales prestando una atención particular a las expectativas de los chefs, tanto estéticas como de uso. Para convertir la mesa en un momento dedicado a los placeres gastronómicos, del más sencillo al más elaborado, DEGRENNE imagina colecciones únicas que encarnan la excelencia y que pueden combinarse entre sí. Jugando con las combinaciones, los contrastes, las formas, los colores y los materiales, cada plato encuentra su lugar en la mesa con armonía, elegancia y sobriedad. Materiales nobles, líneas depuradas, elija todos los saber hacer de DEGRENNE a la hora de preparar su mesa.

COLLECTION L FRAGMENT  P.14

BLOIS  P.120

DOLCE  P.166

NEWPORT  P.138





PORCELAINE DE LIMOGES ET EXCELLENCE

Alliez élégance et sobriété grâce à des matières nobles et des formes aux lignes épurées. D'une blancheur et d'une opalescence remarquables, la Porcelaine de Limoges est symbole d'excellence et de pureté.

LIMOGES PORCELAIN AND EXCELLENCE

Combine elegance and simplicity by harnessing the finest materials and sleek lines. Stunning white and milkily iridescent Limoges porcelain is the epitome of excellence and purity.

PORCELANA DE LIMOGES Y EXCELENCIA

Conjuga elegancia y sobriedad gracias a materiales nobles y formas con líneas depuradas. De una blancura y una opalescencia destacables, la porcelana de Limoges es símbolo de excelencia y de pureza.





227822
ASSIETTE DE PRÉSENTATION
presentation plate w/wide rim
plato redondo
32 cm - 12 in^{5/8}



227823
ASSIETTE PLATE
dinner plate w/wide rim
plato redondo
28 cm - 11 in



227824
ASSIETTE DESSERT
dessert/salad/app.plate w/wide rim
plato redondo
24 cm - 9 in^{3/8}



227825
ASSIETTE À PAIN
bread & butter plate w/wide rim
plato redondo
14 cm - 5 in^{1/2}



227827
ASSIETTE GOURMET
dessert/salad/app.plate w/wide rim
plato redondo
30 cm - 11 in^{13/16}

COMPATIBLE AVEC LES COCOTTES GOURMET
COMPATIBLE WITH GOURMET CASSEROLE

209384



209383
BLANC BRILLANT
bright wight
blanco brillante

209384



209720
BLANC SABLÉ
sandy wight
blanco puro

230820



230821
BLEU
blue
azul

NEW

204042



204041
CARBONE
grey
gris

ASSIETTE/COUVERCLE DE COCOTTE GOURMET
gourmet plate/casserole lid
bol/plato pan gourmet
12,5 cm - 4 in^{15/16}

CORPS DE COCOTTE GOURMET
gourmet casserole body
olla gourmet bol gourmet
14 cm - 50 cl - 5 in^{1/2} - 16 oz^{15/16}

AUTRES COULEURS
GOURMET COMPATIBLES
OTHER COLORS AVAILABLE

NEW



BAHIA P.34



206504
BOUCHON PORCELAINE
POUR CLOCHE VERRE
porcelain lid for glass dome cover
tapa de porcelana para
compaña de vidrio
5,2 cm - 2 in^{1/16}



204043
CLOCHE VERRE BOROSILICATE
glass dome cover
campana vidrio borosilicato
17x9 cm - 6 in^{11/16} x 3 in^{9/16}



182614
CLOCHE INOX
dome cover, stainless steel
compaña
24 cm - 3 in x Ø 9 in^{7/16}



182301
CLOCHE INOX
dome cover, stainless steel
compaña
14,8 cm - 3 in x Ø 5 in^{13/16}



227826
ASSIETTE GOURMET
dessert/salad/app.plate w/wide rim
plato redondo
28 cm - 11 in

COMPATIBLE AVEC LES BOLS GOURMET
COMPATIBLE WITH GOURMET BOWL



186849
BLANC BRILLANT
bright wight
blanco brillante



211893
BLANC SABLÉ
sandy wight
blanco puro



230822
BLEU
blue
azul

NEW



211891
BLANC BRILLANT
bright wight
blanco brillante



211892
BLANC SABLÉ
sandy wight
blanco puro



230823
BLEU
blue
azul

NEW

BOL GOURMET
gourmet bowl
bol gourmet
12 cm - 30 cl - 4 in^{3/4} - 10 oz^{7/8}

MINI BOL GOURMET
small gourmet bowl
mini bol gourmet
7,3 cm - 7 cl - 2 in^{7/8} - 2 oz^{3/8}



227829
TASSE LUNGO
coffee/tea cup
lungo taza
25 cl - 8 oz^{7/16}



227832
SOUCOUBE LUNGO
coffee/tea saucer
lungo plato
15 cm - 5 in^{7/8}



227828
TASSE ESPRESSO
demitasse cup
espresso taza
10 cl - 3 oz^{3/8}



227831
SOUCOUBE ESPRESSO
demitasse saucer
espresso plato
12,5 cm - 4 in^{5/16}



céramique teintée masse
mass colored ceramic
cerámica colorado a toda mesa





L
227843
ASSIETTE DE PRÉSENTATION
presentation plate w/wide rim
plato redondo
32 cm - 12 in^{5/8}



L
227844
ASSIETTE PLATE
dinner plate w/wide rim
plato redondo
28 cm - 11 in



L
227845
ASSIETTE DESSERT
dessert/salad/app.plate w/wide rim
plato redondo
24 cm - 9 in^{3/8}



L
227846
ASSIETTE À PAIN
bread & butter plate w/wide rim
plato redondo
14 cm - 5 in^{1/2}



L
227848
ASSIETTE GOURMET
dessert/salad/app.plate w/wide rim
plato redondo
30 cm - 11 in^{13/16}

COMPATIBLE AVEC LES COCOTTES GOURMET
COMPATIBLE WITH GOURMET CASSEROLE

209384



209383
BLANC BRILLANT
bright wight
blanco brillante

209384



209720
BLANC SABLÉ
sandy wight
blanco puro

230820



230821
BLEU
blue
azul

NEW

204042



204041
CARBONE
grey
gris

ASSIETTE/COUVERCLE DE COCOTTE GOURMET
gourmet plate/casserole lid
bol/plato pan gourmet
12,5 cm - 4 in^{15/16}

CORPS DE COCOTTE GOURMET
gourmet casserole body
olla gourmet bol gourmet
14 cm - 50 cl - 5 in^{1/2} - 16 oz^{15/16}

AUTRES COULEURS
GOURMET COMPATIBLES
OTHER COLORS AVAILABLE

NEW



BAHIA P.34

206504
BOUCHON PORCELAINE
POUR CLOCHE VERRE
porcelain lid for glass dome cover
tapa de porcelana para
campana de vidrio
5,2 cm - 2 in^{1/16}



204043
CLOCHE VERRE BOROSILICATE
glass dome cover
campana vidrio borosilicato
17x9 cm - 6 in^{11/16} x 3 in^{9/16}



182614
CLOCHE INOX
dome cover, stainless steel
campana
24 cm - 3 in x Ø 9 in^{7/16}



182301
CLOCHE INOX
dome cover, stainless steel
campana
14,8 cm - 3 in x Ø 5 in^{13/16}

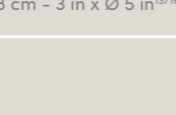

L
227847
ASSIETTE GOURMET
dessert/salad/app.plate w/wide rim
plato redondo
28 cm - 11 in

COMPATIBLE AVEC LES BOLS GOURMET
COMPATIBLE WITH GOURMET BOWL



186849
BLANC BRILLANT
bright wight
blanco brillante



211893
BLANC SABLÉ
sandy wight
blanco puro



230822
BLEU
blue
azul



211891
BLANC BRILLANT
bright wight
blanco brillante



211892
BLANC SABLÉ
sandy wight
blanco puro



230823
BLEU
blue
azul

BOL GOURMET
gourmet bowl
bol gourmet
12 cm - 30 cl - 4 in^{3/4} - 10 oz^{1/8}

MINI BOL GOURMET
small gourmet bowl
mini bol gourmet
7,3 cm - 7 cl - 2 in^{7/8} - 2 oz^{3/8}



L
227829
TASSE LUNGO
coffee/tea cup
lungo taza
25 cl - 8 oz^{7/16}



L
227850
SOUCOUBE LUNGO
coffee/tea saucer
lungo plato
15 cm - 5 in^{7/8}



L
227828
TASSE ESPRESSO
demitasse cup
espresso taza
10 cl - 3 oz^{3/8}



L
227849
SOUCOUBE ESPRESSO
demitasse saucer
espresso plato
12,5 cm - 4 in^{5/16}

NEW

NEW



céramique teintée masse
mass colored ceramic
cerámica colorado a toda masa

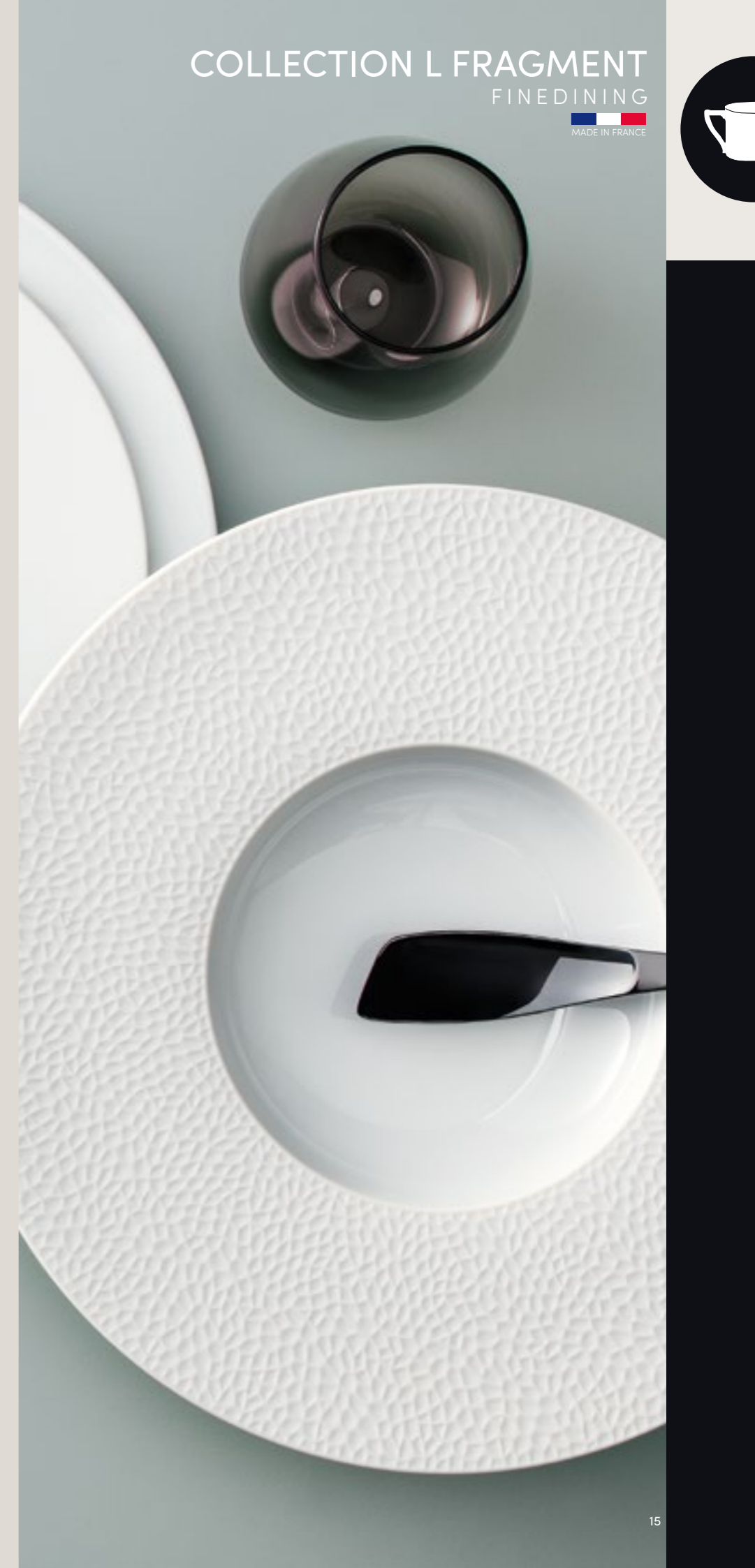



213936
ASSIETTE DE PRÉSENTATION
presentation plate w/wide rim
plato redondo
32 cm - 12 in^{5/8}



213938
ASSIETTE PLATE
dinner plate w/wide rim
plato redondo
28 cm - 11 in



213940
ASSIETTE DESSERT
dessert/salad/app.plate w/wide rim
plato redondo
24 cm - 9 in^{3/8}



213942
ASSIETTE À PAIN
bread & butter plate w/wide rim
plato redondo
14 cm - 5 in^{1/2}



(L)
222366
ASSIETTE GOURMET
dessert/salad/app.plate w/wide rim
plato redondo
30 cm - 11 in^{13/16}

COMPATIBLE AVEC LES COCOTTES GOURMET

209384



209383
BLANC BRILLANT
bright wight
blanco brillante

209384



209720
BLANC SABLÉ
sandy wight
blanco puro

230820 **NEW**



230821
BLEU
blue
azul

204042



204041
CARBONE
grey
gris

ASSIETTE/COUVERCLE DE COCOTTE GOURMET
gourmet plate/casserole lid
bol/plato pan gourmet
12,5 cm - 4 in^{15/16}

CORPS DE COCOTTE GOURMET
gourmet casserole body
olla gourmet bol gourmet
14 cm - 50 cl - 5 in^{1/2} - 16 oz^{15/16}

AUTRES COULEURS
GOURMET COMPATIBLES
OTHER COLORS AVAILABLE

NEW



BAHIA P.34



206504
BOUCHON PORCELAINE
POUR CLOCHE VERRE
porcelain lid for glass dome cover
tapa de porcelana para
campana de vidrio
5,2 cm - 2 in^{1/16}



204043
CLOCHE VERRE BOROSILICATE
glass dome cover
campana vidrio borosilicato
17x9 cm - 6 in^{11/16} x 3 in^{9/16}



182614
CLOCHE INOX
dome cover, stainless steel
campana
24 cm - 3 in x Ø 9 in^{7/16}



182301
CLOCHE INOX
dome cover, stainless steel
campana
14,8 cm - 3 in x Ø 5 in^{13/16}



(L)
222365
ASSIETTE GOURMET
dessert/salad/app.plate w/wide rim
plato redondo
28 cm - 11 in

COMPATIBLE AVEC LES BOLS GOURMET



186849
BLANC BRILLANT
bright wight
blanco brillante



211893
BLANC SABLÉ
sandy wight
blanco puro



230822
BLEU
blue
azul



211891
BLANC BRILLANT
bright wight
blanco brillante



211892
BLANC SABLÉ
sandy wight
blanco puro



230823
BLEU
blue
azul

BOL GOURMET
gourmet bowl
bol gourmet
12 cm - 30 cl - 4 in^{3/4} - 10 oz^{1/8}

MINI BOL GOURMET
small gourmet bowl
mini bol gourmet
7,3 cm - 7 cl - 2 in^{7/8} - 2 oz^{3/8}



207757
TASSE LUNGO
coffee/tea cup
lungo taza
20 cl - 6 oz^{3/4}



223407
SOUCOUBE LUNGO
coffee/tea saucer
lungo plato
15 cm - 5 in^{7/8}



207756
TASSE ESPRESSO
demitasse cup
espresso taza
10 cl - 3 oz^{3/8}

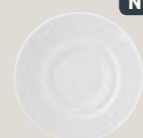

223406
SOUCOUBE ESPRESSO
demitasse saucer
espresso plato
12,5 cm - 4 in^{5/16}



230820
ASSIETTE/COUVERCLE DE COCOTTE GOURMET
gourmet plate/casserole lid
bol/plato pan gourmet
12,5 cm - 4 in^{15/16}

230821
CORPS DE COCOTTE GOURMET
gourmet casserole body
olla gourmet bol gourmet
14 cm - 50 cl - 5 in^{1/2} - 16 oz^{15/16}



230822
BOL GOURMET
gourmet bowl
bol gourmet
12 cm - 30 cl - 4 in^{3/4} - 10 oz^{1/8}



230823
MINI BOL GOURMET
small gourmet bowl
mini bol gourmet
7,3 cm - 7 cl - 2 in^{7/8} - 2 oz^{3/8}



céramique teintée masse
mass colored ceramic
cerámica colorado a toda mesa





207137
ASSIETTE DE PRÉSENTATION OVALE
oval presentation plate
plato presentación oval
34,5 x 29 cm - 13 in^{3/16} x 11 in^{7/16}

207134
ASSIETTE PLATE OVALE
oval dinner plate
plato oval
31 x 26,5 cm - 12 in^{3/16} x 10 in^{7/16}

207135
ASSIETTE DESSERT OVALE
oval dessert plate
plato oval
23,8 x 20,2 cm - 9 in^{7/16} x 3 in^{11/16}

207139
ASSIETTE À PAIN RONDE
round bread & butter plate
plato de pan redondo
16 cm - 6 in^{5/16}

207140
ASSIETTE À PÂTES
round soup/pasta bowl w/wide rim
plato hondo pasta redonda
29 cm - 11 in^{7/16}

207136
ASSIETTE CALOTTE
oval shallow bowl, coupe
plato hondo oval
23,5 x 19 cm - 9 in^{1/4} x 7 in^{1/2}



207142 - ASSIETTE GOURMET OVALE
GRAND BASSIN
shallow bowl w/wide oval rim
plato gourmet oval fondo grande
32x27 cm - 27 cl - 12 in^{5/8} x 10 in^{5/8} - 9 oz



207141 - ASSIETTE GOURMET OVALE
BASSIN PLAT
oval plate w/wide - rim, flat
plato gourmet oval
30 x 26 cm - 12 in^{5/8} x 10 in^{5/8}

COMPATIBLE AVEC LES COCOTTES GOURMET

209384



209383
BLANC BRILLANT
bright wight
blanco brillante

209384



209720
BLANC SABLÉ
sandy wight
blanco puro

230820

NEW



230821
BLEU
blue
azul

204042



204041
CARBONE
grey
gris

ASSIETTE/COUVERCLE DE COCOTTE GOURMET
gourmet plate/casserole lid
bol/plato pan gourmet
12,5 cm - 4 in^{15/16}

CORPS DE COCOTTE GOURMET
gourmet casserole body
olla gourmet bol gourmet
14 cm - 50 cl - 5 in^{1/2} - 16 oz^{15/16}

AUTRES COULEURS
GOURMET COMPATIBLES
OTHER COLORS AVAILABLE

NEW



BAHIA P.34

COMPATIBLE AVEC LES BOLS GOURMET



186849
BLANC BRILLANT
bright wight
blanco brillante



211893
BLANC SABLÉ
sandy wight
blanco puro



230822
BLEU
blue
azul



211891
BLANC BRILLANT
bright wight
blanco brillante



211892
BLANC SABLÉ
sandy wight
blanco puro



230823
BLEU
blue
azul

207138 - ASSIETTE GOURMET OVALE
PETIT BASSIN
shallow bowl w/wide oval rim
plato gourmet oval fondo pequeño
30x26 cm - 17 cl
12 in^{5/8} x 10 in^{5/8} - 5 oz^{2/3}

BOL GOURMET
gourmet bowl
bol gourmet
12 cm - 30 cl - 4 in^{3/4} - 10 oz^{1/8}

MINI BOL GOURMET
small gourmet bowl
mini bol gourmet
7,3 cm - 7 cl - 2 in^{7/8} - 2 oz^{3/8}

206504
BOUCHON PORCELAINE
POUR CLOCHE VERRE
porcelain lid for glass dome cover
tapa de porcelana para
compaña de vidrio
5,2 cm - 2 in^{1/16}



204043
CLOCHE VERRE BOROSILICATE
glass dome cover
campana vidrio borosilicato
17x9 cm - 6 in^{11/16} x 3 in^{9/16}



182614
CLOCHE INOX
dome cover, stainless steel
compaña
24 cm - 3 in x Ø 9 in^{7/16}



182301
CLOCHE INOX
dome cover, stainless steel
compaña
14,8 cm - 3 in x Ø 5 in^{13/16}





186782
SALADIER
salad bowl deep
ensaladera
28 x 24 cm - 11 in x 9 in^{7/16}
H : 11 cm - 4 in^{5/16}



186779
COUPELLE
deep bowl, small
bol
14 x 12 cm - 5 in^{1/2} x 4 in^{11/16}
H : 5 cm - 4 in^{5/16}



200102
PLAT OVALE CREUX
oval chop plate w/rim, flat
plato hondo ovalado
36,5 x 26,5 cm - 14 in^{3/8} x 10 in^{7/16}



186788
PLAT À CAKE
oval long dish w/wide rim, flat
fuente ovalado
40,5 x 19 cm - 15 in^{15/16} x 7 in^{1/2}



VERRINE
ramekin
vaso
186797 - 6 cl - 2 oz - H : 5,5 cm - 2 in^{3/16}
186851 - 12 cl - 4 oz^{1/16} - H : 7 cm - 2 in^{3/4}



NEWPORT P. 60





193319
ASSIETTE DE PRÉSENTATION RONDE
round presentation plate
plato presentación redondo
32,2 cm - 12 in^{1/8}



193318
ASSIETTE PLATE RONDE
round dinner plate
plato redondo
28 cm - 11 in^{1/4}



193320
ASSIETTE DESSERT RONDE
round dessert plate
plato redondo
22,5 cm - 8 in^{7/8}



202470
ASSIETTE À PAIN RONDE
round bread & butter plate
plato de pan redondo
15 cm - 5 in^{7/8}



223954
ASSIETTE À PÂTES
round soup/pasta bowl w/wide rim
plato hondo pasta redonda
29 cm - 11 in^{7/16}



207769 - ASSIETTE GOURMET OVALE
GRAND BASSIN
shallow bowl w/wide oval rim
plato gourmet oval fondo grande
32x27 cm - 27 cl - 12 in^{5/8} x 10 in^{5/8} - 9 oz

COMPATIBLE AVEC LES COCOTTES GOURMET



209384
209383
BLANC BRILLANT
bright wight
blanco brillante



209384
209720
BLANC SABLÉ
sandy wight
blanco puro



230820 **NEW**
230821
BLEU
blue
azul



204042
204041
CARBONE
grey
gris

ASSIETTE/COUVERCLE DE COCOTTE GOURMET
gourmet plate/casserole lid
bol/plato pan gourmet
12,5 cm - 4 in^{15/16}

CORPS DE COCOTTE GOURMET
gourmet casserole body
olla gourmet bol gourmet
14 cm - 50 cl - 5 in^{1/2} - 16 oz^{15/16}

AUTRES COULEURS
GOURMET COMPATIBLES
OTHER COLORS AVAILABLE



NEW

BAHIA P.34



206504
BOUCHON PORCELAINE
POUR CLOCHE VERRE
porcelain lid for glass dome cover
tapa de porcelana para
compaña de vidrio
5,2 cm - 2 in^{1/16}



204043
CLOCHE VERRE BOROSILICATE
glass dome cover
campana vidrio borosilicato
17x9 cm - 6 in^{11/16} x 3 in^{9/16}



182614
CLOCHE INOX
dome cover, stainless steel
compaña
24 cm - 3 in x Ø 9 in^{7/16}



182301
CLOCHE INOX
dome cover, stainless steel
compaña
14,8 cm - 3 in x Ø 5 in^{13/16}



193324 - ASSIETTE GOURMET OVALE
PETIT BASSIN
shallow bowl w/wide oval rim
plato gourmet oval fondo pequeño
30x26 cm - 17 cl
12 in^{5/8} x 10 in^{5/8} - 5 oz^{2/3}

COMPATIBLE AVEC LES BOLS GOURMET



186849
BLANC BRILLANT
bright wight
blanco brillante



211893
BLANC SABLÉ
sandy wight
blanco puro



230822 **NEW**
BLEU
blue
azul



211891
BLANC BRILLANT
bright wight
blanco brillante



211892
BLANC SABLÉ
sandy wight
blanco puro



230823 **NEW**
BLEU
blue
azul

BOL GOURMET
gourmet bowl
bol gourmet
12 cm - 30 cl - 4 in^{3/4} - 10 oz^{1/8}

MINI BOL GOURMET
small gourmet bowl
mini bol gourmet
7,3 cm - 7 cl - 2 in^{7/8} - 2 oz^{3/8}



NEWPORT P. 60



DORÉ - GOLDED - DORADO



225193
ASSIETTE DE PRÉSENTATION
presentation plate w/wide rim
plato presentación
33 cm - 13 in



225194
ASSIETTE PLATE
dinner plate w/wide rim
plato redondo
28,5 cm - 11 in^{1/4}



225195
ASSIETTE DESSERT
dessert/salad/app.plate w/wide rim
plato redondo
22,5 cm - 8 in^{7/8}



225197 - ASSIETTE GOURMET OVALE
GRAND BASSIN
shallow bowl w/wide oval rim
plato gourmet oval fondo grande
30x26 cm - 27 cl - 11 in^{13/16} x 10 in^{1/4} - 9 oz

ARGENT - SILVERPLATED - PLATEADO



225198
ASSIETTE DE PRÉSENTATION
presentation plate w/wide rim
plato presentación
33 cm - 13 in

BLANC - WHITE - BLANCO



197428
VASE
vase
florero decoración
30 cm - 11 in^{13/16}



197427
VASE
vase
florero decoración
20 cm - 7 in^{7/8}



199007
SOLIFLORE
bud vase, single
florero
25 cm - 9 in^{13/16}



NEWPORT P. 60





DUNE - BEIGE DUNE



230921
ASSIETTE PLATE
dinner plate w/wide rim
plato redondo
29 cm - 11 in^{7/16}



230920
ASSIETTE PLATE
dinner plate w/wide rim
plato redondo
26 cm - 10 in^{1/4}



230919
ASSIETTE PLATE
dinner plate w/wide rim
plato redondo
23 cm - 9 in^{1/8}



230922
ASSIETTE CREUSE
shallow bowl
plato hondo
20 cm - 7 in^{7/8}



230918
ASSIETTE À PAIN
bread & butter plate w/wide rim
plato redondo
14 cm - 5 in^{1/2}

BASALTE - BROWN BASALT



230938
ASSIETTE PLATE
dinner plate w/wide rim
plato redondo
29 cm - 11 in^{7/16}



230937
ASSIETTE PLATE
dinner plate w/wide rim
plato redondo
26 cm - 10 in^{1/4}



230936
ASSIETTE PLATE
dinner plate w/wide rim
plato redondo
23 cm - 9 in^{1/8}



230939
ASSIETTE CREUSE
shallow bowl
plato hondo
20 cm - 7 in^{7/8}



230935
ASSIETTE À PAIN
bread & butter plate w/wide rim
plato redondo
14 cm - 5 in^{1/2}

ARGILE VERTE - GREEN CLAY



230952
ASSIETTE PLATE
dinner plate w/wide rim
plato redondo
29 cm - 11 in^{7/16}



230951
ASSIETTE PLATE
dinner plate w/wide rim
plato redondo
26 cm - 10 in^{1/4}



230950
ASSIETTE PLATE
dinner plate w/wide rim
plato redondo
23 cm - 9 in^{1/8}



230953
ASSIETTE CREUSE
shallow bowl
plato hondo
20 cm - 7 in^{7/8}



230949
ASSIETTE À PAIN
bread & butter plate w/wide rim
plato redondo
14 cm - 5 in^{1/2}

NEW BAHIA
ALLDAYDINING

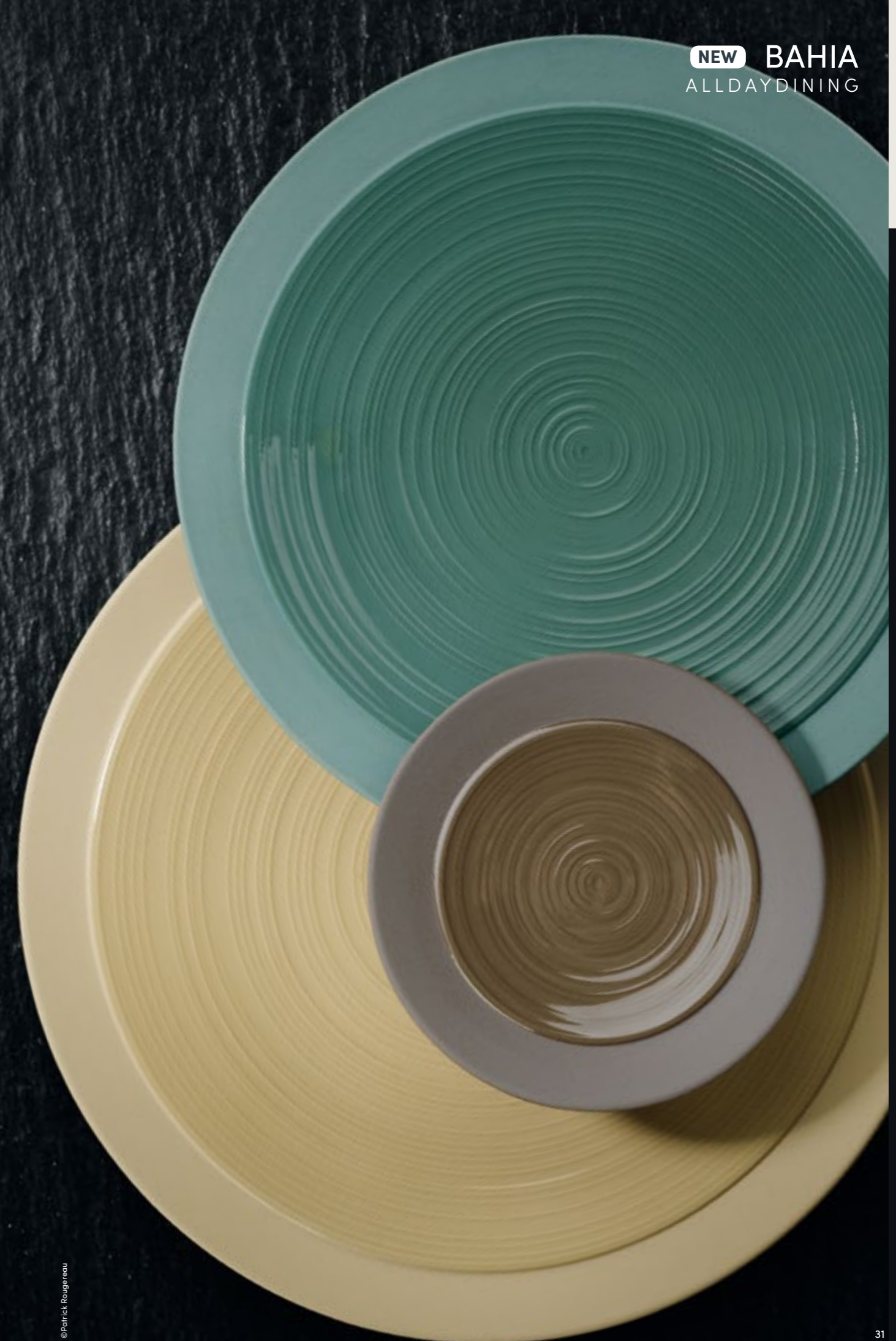

©Patrick Roggeureau

ROSE SABLE - PINK SAND



230904
ASSIETTE PLATE
dinner plate w/wide rim
plato redondo
29 cm - 11 in^{7/16}

230903
ASSIETTE PLATE
dinner plate w/wide rim
plato redondo
26 cm - 10 in^{1/4}

230902
ASSIETTE PLATE
dinner plate w/wide rim
plato redondo
23 cm - 9 in^{1/8}

230905
ASSIETTE CREUSE
shallow bowl
plato hondo
20 cm - 7 in^{7/8}

230901
ASSIETTE À PAIN
bread & butter plate w/wide rim
plato redondo
14 cm - 5 in^{1/2}

BLEU DE ROCHE - BLUE STONE



230966
ASSIETTE PLATE
dinner plate w/wide rim
plato redondo
29 cm - 11 in^{7/16}

230965
ASSIETTE PLATE
dinner plate w/wide rim
plato redondo
26 cm - 10 in^{1/4}

230964
ASSIETTE PLATE
dinner plate w/wide rim
plato redondo
23 cm - 9 in^{1/8}

230967
ASSIETTE CREUSE
shallow bowl
plato hondo
20 cm - 7 in^{7/8}

230963
ASSIETTE À PAIN
bread & butter plate w/wide rim
plato redondo
14 cm - 5 in^{1/2}

NEW BAHIA
ALLDAYDINING

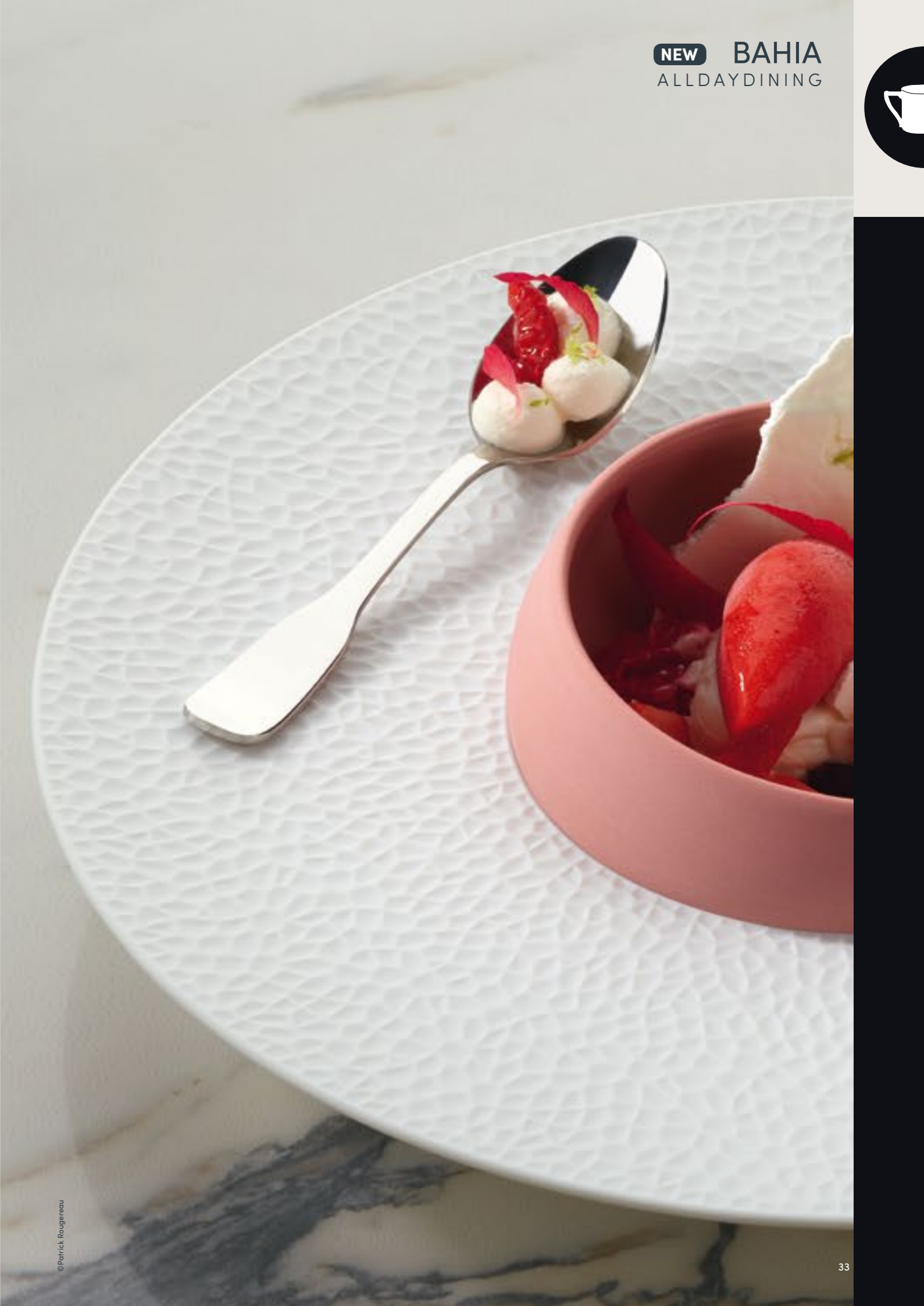

DUNE - BEIGE DUNE



230924



230928
230927



230923



230926
230925

BASALTE - BROWN BASALT



230941



230945
230944



230940



230943
230942

ARGILE VERTE - GREEN CLAY



230955



230959
230958



230954



230957
230956

BLEU DE ROCHE - BLUE STONE

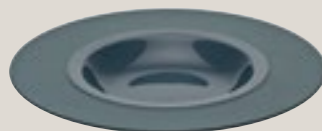

230969



230973
230972



230968



230971
230970

ROSE SABLE - PINK SAND



230907



230911
230910
ASSIETTE/COUVERCLE DE COCOTTE
GOURMET
gourmet plate/casserole lid
bol/plato pan gourmet
12,5 cm - 4 in^{15/16}



230906



230909
230908

ASSIETTE GOURMET GRAND BASSIN
shallow bowl w/wide round rim
plato gourmet hondo fondo grande
26 cm - 10 in^{5/8}

CORPS DE COCOTTE GOURMET
gourmet casserole body
olla gourmet bol gourmet
14 cm - 50 cl - 5 in^{1/2} - 16 oz^{15/16}

ASSIETTE GOURMET PETIT BASSIN
shallow bowl w/wide round rim
plato gourmet redondo fondo
pequeño
23 cm - 9 in^{1/16}

BOL GOURMET
gourmet bowl
bol gourmet
12 cm - 30 cl
4 in^{3/4} - 10 oz^{1/8}

MINI BOL GOURMET
small gourmet bowl
mini bol gourmet
7,3 cm - 7 cl
2 in^{7/8} - 2 oz^{3/8}



206504
BOUCHON PORCELAINE
POUR CLOCHE VERRE
porcelain lid for glass dome cover
tapa de porcelana para
compaña de vidrio
5,2 cm - 2 in^{1/16}



204043
CLOCHE VERRE BOROSILICATE
glass dome cover
campana vidrio borosilicato
17x9 cm - 6 in^{11/16} x 3 in^{9/16}



182614
CLOCHE INOX
dome cover, stainless steel
campana
24 cm - 3 in x Ø 9 in^{7/16}



182301
CLOCHE INOX
dome cover, stainless steel
campana
14,8 cm - 3 in x Ø 5 in^{13/16}



PIERRE DE LAVE - LAVA STONE - PIEDRA DE LAVA

NEW MODULO NATURE
ALLDAYDINING

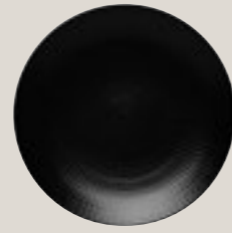
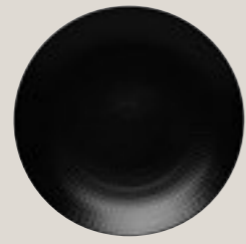
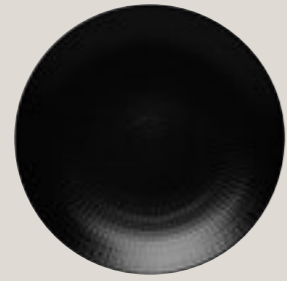
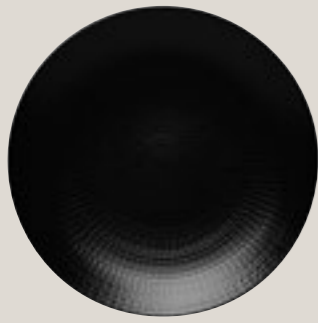

194455
ASSIETTE DE PRÉSENTATION
presentation plate
plato presentación
31,5 cm - 12 in^{3/8}

194454
ASSIETTE PLATE
dinner plate
plato redondo
28 cm - 11 in

194453
ASSIETTE DESSERT
dessert /salad plate
plato llano
21 cm - 8 in^{1/4}

194452
ASSIETTE CALOTTE
salad deep/bowl
plato hondo
21 cm - 8 in^{1/4}
H : 4 cm - 1 in^{5/8}

230092
ASSIETTE À PAIN
bread & butter plate w/wide rim
plato de pan
16 cm - 6 in^{5/16}



194462
SALADIER
salad bowl
ensaladera
24 cm - 9 in^{7/16}
H : 8 cm - 3 in^{3/16}

194457
COUPE
salad /deep bowl
bol
17,7 cm - 6 in^{15/16}
H : 5,5 cm - 2 in^{3/16}

194456
BOL À DEJEUNER
soup/breakfast bowl
bol desayuno
14 cm - 58 cl
5 in^{1/2} - 19 oz^{5/8}

194458
COUPELLE
small bowl, cup
bol pequeño
10 cm - 3 in^{15/16}
H : 6 cm - 2 in^{3/8}



194459
TASSE À CAFÉ
demitasse cup
taza de café
11,5 cl - 3 oz^{7/8}

230093
TASSE À THÉ
tea cup
taza de tè
25 cl - 6 oz^{3/4}

194461
MUG À THÉ
mug
tè mug
33 cl - 11 oz^{3/16}



194460
SOUCOUBE À CAFÉ
demitasse saucer
espresso café
12,5 cm - 4 in^{15/16}

230094
SOUCOUBE À THÉ
demitasse /tea saucer
plato té
15 cm - 5 oz^{7/8}



BLEU GALET - BLUE - AZUL



225342
ASSIETTE DE PRÉSENTATION
presentation plate
plato presentación
31,5 cm - 12 in^{3/8}

225343
ASSIETTE PLATE
dinner plate
plato redondo
28 cm - 11 in

225344
ASSIETTE DESSERT
dessert /salad plate
plato llano
21 cm - 8 in^{1/4}

NEW



225345
ASSIETTE CALOTTE
salad deep/bowl
plato hondo
21 cm - 8 in^{1/4}
H : 4 cm - 1 in^{5/8}

225353
ASSIETTE À PAIN
bread & butter plate
w/wide rim
plato de pan
16 cm - 6 in^{5/16}



225349
SALADIER
salad bowl
ensaladera
24 cm - 9 in^{7/16}
H : 8 cm - 3 in^{3/16}



225347
COUPE
salad /deep bowl
bol
17,7 cm - 6 in^{15/16}
H : 5,5 cm - 2 in^{3/16}



225352
SOUCOUBE À CAFÉ
demitasse saucer
espresso café
12,5 cm - 4 in^{15/16}



225351
TASSE À CAFÉ
demitasse cup
taza de café
11,5 cl - 3 oz^{7/8}



230168
SOUCOUBE À THÉ
demitasse /tea saucer
plato té
15 cm - 5 oz^{7/8}

NEW



230167
TASSE À THÉ
tea cup
taza de tè
25 cl - 6 oz^{3/4}



225346
COUPELLE
small bowl, cup
bol pequeño
10 cm - 3 in^{15/16}
H : 6 cm - 2 in^{3/8}

KAOLIN - CAOLÍN



184088
ASSIETTE DE PRÉSENTATION
presentation plate
plato presentación
31,5 cm - 12 in^{3/8}

184077
ASSIETTE PLATE
dinner plate
plato redondo
28 cm - 11 in

184078
ASSIETTE DESSERT
dessert /salad plate
plato llano
21 cm - 8 in^{1/4}



184079
ASSIETTE CALOTTE
salad deep/bowl
plato hondo
21 cm - 8 in^{1/4}
H : 4 cm - 1 in^{5/8}



209092
ASSIETTE À PAIN
bread & butter plate
w/wide rim
plato de pan
16 cm - 6 in^{5/16}



184087
SALADIER
salad bowl
ensaladera
24 cm - 9 in^{7/16}
H : 8 cm - 3 in^{3/16}



184086
COUPE
salad /deep bowl
bol
17,7 cm - 6 in^{15/16}
H : 5,5 cm - 2 in^{3/16}



184089
PLAT RECTANGULAIRE
rectangular dish
fuente rectangular
38 x 15,5 cm - 15 in x 5 in^{15/16}

NEW



184082
SOUCOUBE À CAFÉ
demitasse saucer
espresso café
12,5 cm - 4 in^{15/16}



184081
TASSE À CAFÉ
demitasse cup
taza de café
11,5 cl - 3 oz^{7/8}



230163
SOUCOUBE À THÉ
demitasse /tea saucer
plato té
15 cm - 5 oz^{7/8}

NEW



230164
TASSE À THÉ
tea cup
taza de tè
25 cl - 6 oz^{3/4}



184083
MUG À THÉ
mug
tè mug
33 cl - 11 oz^{3/16}



184085
COUPELLE
small bowl, cup
bol pequeño
10 cm - 3 in^{15/16}
H : 6 cm - 2 in^{3/8}



184084
BOL À DEJEUNER
soup/breakfast bowl
bol desayuno
14 cm - 58 cl
5 in^{1/2} - 19 oz^{5/8}

MODULO NATURE ALLDAYDINING



TERRE D'OMBRE - TAUPE - TIERRA DE SOMBRA



184101
ASSIETTE DE PRÉSENTATION
presentation plate
plato presentación
31,5 cm - 12 in^{3/8}

184090
ASSIETTE PLATE
dinner plate
plato redondo
28 cm - 11 in

184091
ASSIETTE DESSERT
dessert /salad plate
plato llano
21 cm - 8 in^{1/4}



184092
ASSIETTE CALOTTE
salad deep/bowl
plato hondo
21 cm - 8 in^{1/4}
H : 4 cm - 1 in^{5/8}



209093
ASSIETTE À PAIN
bread & butter plate
w/wide rim
plato de pan
16 cm - 6 in^{5/16}



184100
SALADIER
salad bowl
ensaladera
24 cm - 9 in^{7/16}
H : 8 cm - 3 in^{3/16}



184099
COUPE/CALOTTE
salad /deep bowl
bol
17,7 cm - 6 in^{15/16}
H : 5,5 cm - 2 in^{3/16}



184095
SOUCOUE À CAFÉ
demitasse saucer
espresso café
12,5 cm - 4 in^{15/16}



184094
TASSE À CAFÉ
demitasse cup
taza de café
11,5 cl - 3 oz^{7/8}



230166
SOUCOUE À THÉ
demitasse /tea saucer
plato té
15 cm - 5 oz^{7/8}



230165
TASSE À THÉ
tea cup
taza de tè
25 cl - 6 oz^{3/4}



184096
MUG À THÉ
mug
tè mug
33 cl - 11 oz^{3/16}



184098
COUPELLE
small bowl, cup
bol pequeño
10 cm - 3 in^{15/16}
H : 6 cm - 2 in^{3/8}



184097
BOL À DEJEUNER
soup/breakfast bowl
bol desayuno
14 cm - 5 1/2 in - 19 oz^{5/8}

TOMETTE - RED - ROJO



205273
ASSIETTE DE PRÉSENTATION
presentation plate
plato presentación
31,5 cm - 12 in^{3/8}

205270
ASSIETTE PLATE
dinner plate
plato redondo
28 cm - 11 in

205271
ASSIETTE DESSERT
dessert /salad plate
plato llano
21 cm - 8 in^{1/4}



205272
ASSIETTE CALOTTE
salad deep/bowl
plato hondo
21 cm - 8 in^{1/4}
H : 4 cm - 1 in^{5/8}



209094
ASSIETTE À PAIN
bread & butter plate
w/wide rim
plato de pan
16 cm - 6 in^{5/16}



205276
SALADIER
salad bowl
ensaladera
24 cm - 9 in^{7/16}
H : 8 cm - 3 in^{3/16}



205274
COUPE
salad /deep bowl
bol
17,7 cm - 6 in^{15/16}
H : 5,5 cm - 2 in^{3/16}



222023
SOUCOUE À CAFÉ
demitasse saucer
espresso café
12,5 cm - 4 in^{15/16}



222022
TASSE À CAFÉ
demitasse cup
taza de café
11,5 cl - 3 oz^{7/8}



205275
COUPELLE
small bowl, cup
bol pequeño
10 cm - 3 in^{15/16}
H : 6 cm - 2 in^{3/8}



BLANC - WHITE - BLANCO



207120
ASSIETTE DE PRÉSENTATION
presentation coupe plate
plato presentación
32 cm - 12 in^{5/8}



207112
ASSIETTE PLATE
dinner coupe plate
plato redondo
29 cm - 11 in^{5/16}



207113
ASSIETTE PLATE
dinner coupe plate
plato redondo
26 cm - 10 in^{1/4}



207111
ASSIETTE DESSERT
dessert/salad/app.coupe plate
plato redondo
20 cm - 7 in^{7/8}



207119
ASSIETTE À PAIN
bread & butter coupe plate
plato de pan
15 cm - 5 in^{7/8}



188537
BOL À SOUPE
med bowl, soup
bol hondo
13 cm - 5 in^{1/8}
H : 6 cm - 2 in^{3/8}



207114
ASSIETTE CREUSE/
CALOTTE
round shallow bowl
plato hondo
20 cm - 7 in^{7/8}



136535
COUPE
pasta/salad/seafood bowl, footed
bol
24 cm - 9 in^{7/16}
H : 11 cm - 4 in^{1/4}



136532
COUPE
shallow bowl, footed
bol
16 cm - 6 in^{5/16}
H : 7,5 cm - 2 in^{15/16}



136530
COUPE
shallow bowl, footed
bol
8 cm - 3 in^{1/8}
H : 2,5 cm - 1 in



142722
BOL
deep bowl, large
bol hondo
28 cm - 11 in
contenance : 2,5 L
capacity : 84 oz^{2/16}
H : 12 cm - 4 in^{3/4}



136529
BOL
deep bowl, medium
bol hondo
24 cm - 9 in^{7/16}
contenance : 2 L
capacity : 67 oz^{5/8}
H : 11 cm - 4 in^{1/4}



136511
BOL
deep bowl, medium
bol hondo
20 cm - 7 in^{7/8}
contenance : 1,30 L
capacity : 43 oz^{15/16}
H : 9,5 cm - 3 in^{3/4}



136528
BOL
deep bowl, individual
bol hondo
16 cm - 6 in^{5/16}
contenance : 22 oz^{5/8}
H : 7,5 cm - 2 in^{15/16}



154245
BOL
deep bowl, soup
bol hondo
14 cm - 5 in^{1/2}
contenance : 55 cl
capacity : 18 oz^{5/8}
H : 8 cm - 2 in^{11/16}



136510
BOL
deep bowl, rice
bol hondo
12 cm - 4 in^{3/4}
contenance : 27 cl
capacity : 9 oz^{1/8}
H : 5,5 cm - 2 in^{3/16}



136509
BOL
deep bowl, ramekin
bol hondo
8 cm - 3 in^{1/8}
contenance : 8 cl
capacity : 3 oz^{1/8}
H : 4,5 cm - 1 in^{3/4}

GRIS PERLE - LIGHT GREY

NEW



230142
BOL
deep bowl, medium
bol hondo
24 cm - 9 in^{7/16}
contenance : 2 L
capacity : 67 oz^{5/8}
H : 11 cm - 4 in^{1/4}



230141
BOL
deep bowl, medium
bol hondo
20 cm - 7 in^{7/8}
contenance : 1,30 L
capacity : 43 oz^{15/16}
H : 9,5 cm - 3 in^{3/4}



230140
BOL
deep bowl, individual
bol hondo
16 cm - 6 in^{5/16}
contenance : 22 oz^{5/8}
H : 7,5 cm - 2 in^{15/16}



230139
BOL À DÉJEUNER
soup/breakfast bowl
bol desayuno
14 cm - 5 in^{1/2}
contenance : 55 cl
capacity : 18 oz^{5/8}
H : 8 cm - 2 in^{11/16}



230138
BOL À THÉ
tea bowl, ramekin
bol hondo
9 cm - 3 in^{9/16}
contenance : 20 cl
capacity : 6 oz^{3/4}
H : 4,5 cm - 1 in^{3/4}

MODULO
ALLDAYDINING





207118
ASSIETTE DE PRÉSENTATION
presentation coupe plate
plato presentación
28 cm - 11 in



207115
ASSIETTE PLATE
dinner coupe plate
plato redondo
24 cm - 9 in^{7/16}



207117
ASSIETTE DESSERT
dessert/salad/app.coupe plate
plato redondo
20 cm - 7 in^{7/8}



207123
ASSIETTE À PAIN
bread & butter coupe plate
plato de pan
14 cm - 5 in^{1/2}

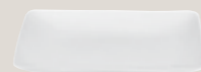

207116
ASSIETTE CREUSE
round soup/salad, coupe plate
plato hondo, cuadrado
20 cm - 7 in^{7/8}



149831
PLAT CREUX
square deep dish, coupe
plato hondo cuadrado
28 cm - 11 in
H : 5,5 cm - 2 in^{3/16}



154244
PLAT CREUX
square deep dish, coupe
plato hondo cuadrado
16 cm - 6 in^{5/16}
H : 6 cm - 2 in^{3/8}



136502
COUPE
square bowl, footed coupe
bol cuadrado
12 cm - 4 in^{3/4}
H : 3,5 cm - 1 in^{3/8}



136503
COUPE
square bowl, footed coupe
bol cuadrado
8 cm - 3 in^{1/8}
H : 2,5 cm - 1 in



181483
BOL CARRÉ
square bowl, deep
bol cuadrado hondo
12 cm - 4 in^{3/4}
H : 3,5 cm - 1 in^{3/8}



181485
ASSIETTE PLATE
presentation coupe plate
plato rectangular
34x26 cm - 13 in^{3/8} x 10 in^{1/4}



207122
ASSIETTE PLATE
dinner coupe plate
plato rectangular
30x22 cm - 11 in^{13/16} x 8 in^{11/16}

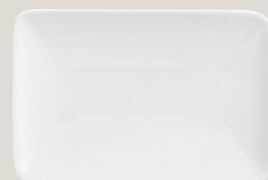

207110
ASSIETTE DESSERT
dessert/salad/app coupe plate
plato rectangular
26x18 cm - 10 in^{1/4} x 7 in^{1/16}

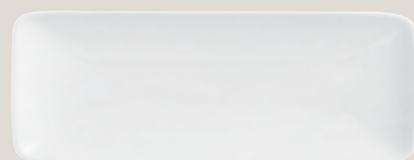

207754
PLAT RECTANGULAIRE
rectangular dish, coupe large
plato rectangular
40x16 cm - 15 in^{3/4} x 6 in^{5/16}



207753
PLAT RECTANGULAIRE
rectangular dish, coupe large
plato rectangular
20x12 cm - 7 in^{7/8} x 4 in^{3/4}



©Julie ANSIAU

ACCESSOIRES - ACCESSORIES - ACCESORIOS



136524
PLAT À TARTE
pie/pizza plate, flat
fuente para pastel
32 cm - 12 in^{5/8}



181490
VERRINE PORCELAINE
ramekin
vasito porcelana
8 cl - 2 oz^{11/16}



209381
PRÉSENTOIR À GÂTEAUX
round app/pizza/presentation stand
expositor de tartas
25 cm - 9 in^{13/16}
H : 8,5 cm - 2 in^{3/16}



182915
COFFRET SALIÈRE/POIVRIÈRE
salt & pepper cruet
salero y pimentero



216472
VASE
vase
jarrón
12,7x H 25 cm - 5 in x h 9 in^{13/16}



216477
SOLIFLORE
vase
jarrón individual
7x H 17,5 cm - 2 in^{3/4} x h 6 in^{7/8}



209382
PRÉSENTOIR À GÂTEAUX
round app/pizza/presentation stand
expositor de tartas
32 cm - 12 in^{5/8}
H : 10,5 cm - 4 in^{1/4}



SALAM THE P. 58

MODULO
ALLDAYDINING



API



207131
ASSIETTE PLATE RECTANGLE
6 COMPARTIMENTS
rectangular dinner plate
6 compartments
plato rectangular/6 compartimentos
27x18 cm - 10 in^{5/8} x 7 in^{1/16}



207133
SOUCOUPE RECTANGULAIRE
rectangular plate/ saucer
plato rectangular
27x9 cm - 10 in^{5/8} x 3 in^{9/16}

API
ALLDAYDINING





207126
assiette plate
presentation plate
plato presentación
32 cm - 12in^{5/8}



207125
ASSIETTE PLATE
dinner plate
plato
28 cm - 11 in



207127
ASSIETTE DESSERT
dessert/salad/app. plate
plato
24 cm - 9 in^{7/16}



207124
ASSIETTE À PAIN
bread & butter plate
plato
16 cm - 6 in^{5/16}



198047
SALADIER/BOL
deep bowl, soup /salad
ensaladera
20 cm - 7in^{7/8}



Relais Bernard Loiseau





161012
ASSIETTE CREUSE
shallow coupe bowl, large
plato hondo
30 cm - 11 in^{13/16}



161011
ASSIETTE CREUSE
shallow coupe bowl, medium
plato hondo
23 cm - 9 in^{1/16}



161038
ASSIETTE PLATE
bread & butter plate
plato redondo
16 cm - 6 in^{5/16}



198017
POT À SAUCE/GARNITURE
ramekin, large
pot
48 cl - Ø 10,5 cm - 16 oz^{1/4} - 4 in^{1/8}
H : 8 cm - 2 in^{11/16}



198016
POT À SAUCE/GARNITURE
ramekin, sugar bowl
pot
20 cl - Ø 8 cm - 6 oz^{3/4} - 3 in^{1/8}
H : 7 cm - 2 in^{8/16}



196561
POT À SAUCE/GARNITURE
ramekin, small
pot
7,5 cl - Ø 5,5 cm - 2 oz^{2/16} - 2 in^{3/16}
H : 6,5 cm



161016
SALADIER
deep bowl, large
ensaladera
32 cm - 12 in^{5/8}
contenance : 250 cl
capacity : 84 oz^{9/16}
H : 14 cm - 5 in^{1/2}



161015
SALADIER
deep bowl, medium
ensaladera
24 cm - 9 in^{13/16}
contenance : 150 cl
capacity : 50 oz^{3/4}
H : 11,5 cm - 4 in^{1/4}



161014
SALADIER/BOL
deep bowl, individual
bol
16,5 cm - 6 in^{1/2}
contenance : 50 cl
capacity : 16 oz^{15/16}
H : 9 cm - 3 in^{15/16}



161013
SALADIER/BOL
deep bowl, cup
bol
9 cm - 3 in^{9/16}
contenance : 20 cl
capacity : 6 oz^{3/4}
H : 7 cm - 2 in^{8/16}



161020
COQUETIER
egg cup, plate
huevera
15 cm - 5 in^{7/8}



161037
RAVIER
shallow ramekin, coupe
bol
10 cm - 3 in^{15/16}
H : 4 cm - 1 in^{3/8}



161036
SUPPORT PLATEAU
tray stand, 3 places
fuente con 3 espacios
30 x 10 cm - 12 in x 3 in^{15/16}



207766
TASSE ESPRESSO
espresso cup
espresso taza
6 cl - 2 oz



208948
TASSE CAFÉ
demitasse cup
taza de café
11 cl - 3 oz^{3/4}



207767
TASSE THÉ/LUNGO
coffee/tea cup
lungo taza
20 cl - 6 oz^{3/4}



207768
TASSE DÉJEUNER
breakfast cup
taza desayuno
48 cl - 16 oz^{1/4}



207765
MUG
mug
mug
50 cl - 16 oz^{1/8}



209189
MUG
mug
mug
30 cl - 10 oz^{15/16}



161025
SOUCOUBE CAFÉ/ESPRESSO
demitasse/espresso saucer
espresso plato
15 cm - 5 in^{7/8}



161028
SOUCOUBE THÉ/LUNGO
coffee/tea saucer
lungo plato
18 cm - 7 in^{1/16}



161034
SOUCOUBE DÉJEUNER
breakfast saucer
plato desayuno
21 cm - 8 in^{1/4}



214688
SOUCOUBE UNIVERSELLE
universal saucer cup
plato universal
13 cm - 5 in^{1/8}



LA CAFÈTERIE - TEATIME -TÉ CAFÉ

Le Thé & le Café sont des univers où le plaisir des sens est décuplé par le plaisir esthétique. Pour rendre ces instants de dégustation uniques, DEGRENNE propose une large sélection de tasses et accessoires.

Collection iconique de la marque depuis 1953, redécouvrez Salam et réunissez tous les éléments pour maîtriser l'Art du Thé.

Drinking tea and coffee is a sensory delight heightened by the sheer aesthetic pleasure of the experience. DEGRENNE offers a wide range of cups and accessories to make tea and coffee drinking a unique experience.

An iconic Degrenne collection since 1953 – why not seize the opportunity to rediscover Salam and gather together the essentials needed to be skilled in the art of tea.

El Té y el Café son universos en los que el placer de los sentidos se potencia con el placer estético. Para hacer que esos instantes de degustación sean únicos, DEGRENNE propone una amplia selección de tazas y accesorios.

Colección única de la marca desde 1953, redescubra Salam y reúna todos los elementos para dominar el arte del té.



REVISITER UNE ICÔNE

Créée en 1953, la théière Salam est le produit emblématique de la marque DEGRENNE. La finesse de la porcelaine alliée à l'éclat de la cloche sublime l'instant thé. Grâce à sa cloche tapissée d'une feutrine, le thé conserve une température optimale deux fois plus longtemps que dans une théière classique. Un procédé astucieux qui permet au thé de déployer toute la subtilité de ses saveurs au fil de la dégustation.

REVISIT AN ICON

Created in 1953, Salam teapot is the iconic product of DEGRENNE. The finesse of porcelain combined with the radiance of the outer body enhances the tea experience. With its inner lining of thin felt, the tea inside is kept at its optimum temperature for twice as long as in a regular teapot. This is a clever trick to ensure that the tea is infused with all the subtlety of its flavours as the tasting progresses.

VOLVER A EXPLORAR UN ICONO

Creada en 1953, la tetera Salam es el producto emblemático de la marca DEGRENNE. La finura de la porcelana combinada con el brillo del cuerpo de la tetera sublima el instante del té. Gracias a su cuerpo tapizado con fieltro, el té conserva una temperatura óptima el doble de tiempo que una tetera clásica. Este ingenioso proceso permite que el té despliegue toda la sutilidad de sus aromas a lo largo de la degustación.



FEUTRE NOIR ISOLANT
tea pot black felt
fieltro negro aislante

CLOCHE ACIER OU INOX
stainless steel or aluminium dome cover
campana acero inoxidable o aluminio

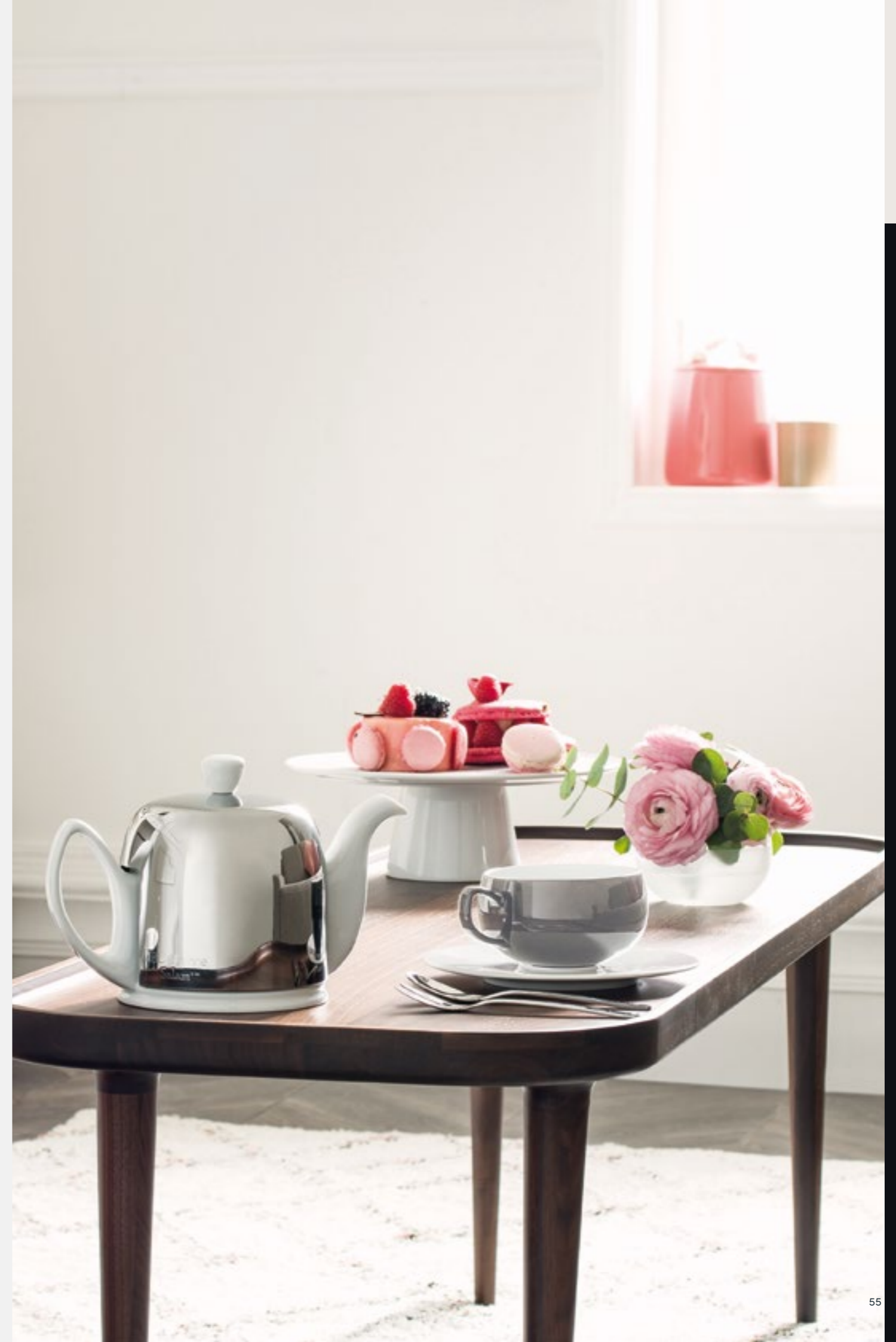

SALAM BLANC - WHITE - BLANCO



211990
THÉIÈRE 8 TASSES
tea pot 8 cups
tetera 8 tazas
130 cl - 43 oz^{13/16}



211989
THÉIÈRE 6 TASSES
tea pot 6 cups
tetera 6 tazas
100 cl - 33 oz^{13/16}



211988
THÉIÈRE 4 TASSES
tea pot 4 cups
tetera 4 tazas
70 cl - 23 oz^{13/16}



211987
THÉIÈRE 2 TASSES
tea pot 2 cups
tetera 2 tazas
35 cl - 11 oz^{13/16}



205135
BOUCHON PORCELAINE THÉIÈRE - 2/4 T
porcelain lid for tea pot - 2/4 c
tapa de porcelana tetera - 2/4 t



189949
CORPS THÉIÈRE 8 TASSES
tea pot 8 cups without lid
cuerpo tetera 8 tazas



189948
CORPS THÉIÈRE 6 TASSES
tea pot 6 cups without lid
cuerpo tetera 6 tazas



189947
CORPS THÉIÈRE 4 TASSES
tea pot 4 cups without lid
cuerpo tetera 4 tazas



189946
CORPS THÉIÈRE 2 TASSES
tea pot 2 cups without lid
cuerpo tetera 2 tazas



205136
BOUCHON PORCELAINE THÉIÈRE - 6/8 T
porcelain lid for tea pot - 6/8 c
tapa de porcelana tetera - 6/8 t

SALAM NOIRE - BLACK - NEGRO



211994
THÉIÈRE 8 TASSES
tea pot 8 cups
tetera 8 tazas
130 cl - 43 oz^{15/16}



211993
THÉIÈRE 6 TASSES
tea pot 6 cups
tetera 6 tazas
100 cl - 33 oz^{13/16}



211992
THÉIÈRE 4 TASSES
tea pot 4 cups
tetera 4 tazas
70 cl - 23 oz^{13/16}



211991
THÉIÈRE 2 TASSES
tea pot 2 cups
tetera 2 tazas
35 cl - 11 oz^{13/16}



210575
BOUCHON PORCELAINE THÉIÈRE - 2/4 T
porcelain lid for tea pot - 2/4 c
tapa de porcelana tetera - 2/4 t



150447
CORPS THÉIÈRE 8 TASSES
tea pot 8 cups without lid
cuerpo tetera 8 tazas



150456
CORPS THÉIÈRE 6 TASSES
tea pot 6 cups without lid
cuerpo tetera 6 tazas



150455
THÉIÈRE 4 TASSES
tea pot 4 cups
tetera 4 tazas
70 cl - 23 oz^{13/16}



150450
THÉIÈRE 2 TASSES
tea pot 2 cups
tetera 2 tazas
35 cl - 11 oz^{13/16}



210576
BOUCHON PORCELAINE THÉIÈRE - 6/8 T
porcelain lid for tea pot - 6/8 c
tapa de porcelana tetera - 6/8 t

Salam noire mat/cloche alu - Black mat/aluminium lid - Negro - campana aluminio

Salam Color blanc cloche alu Bronze - White/Bronze aluminium lid - Blanco/Campana bronce aluminio



216414
THÉIÈRE 6 TASSES
tea pot 6 cups
tetera 6 tazas
100 cl - 33 oz^{13/16}



216410
THÉIÈRE 4 TASSES
tea pot 4 cups
tetera 4 tazas
70 cl - 23 oz^{13/16}



216415
THÉIÈRE 6 TASSES
tea pot 6 cups
tetera 6 tazas
100 cl - 33 oz^{13/16}



216411
THÉIÈRE 4 TASSES
tea pot 4 cups
tetera 4 tazas
70 cl - 23 oz^{13/16}



INFUSEUR
stainless steel filter
filtro tetera
147992 - 2 TASSES
2 cups - 2 tazas
147994 - 4 TASSES
4 cups - 4 tazas
147993 - 6/8 TASSES
6/8 cups - 6/8 tazas

Salam Color blanc cloche alu Zinc - White/Zinc aluminium lid - Blanco/ Campana zinc aluminio

Salam Color blanc cloche alu Bleue - White/Blue aluminium lid - Blanco/ Campana azul aluminio



216416
THÉIÈRE 6 TASSES
tea pot 6 cups
tetera 6 tazas
100 cl - 33 oz^{13/16}



216412
THÉIÈRE 4 TASSES
tea pot 4 cups
tetera 4 tazas
70 cl - 23 oz^{13/16}



225359
THÉIÈRE 6 TASSES
tea pot 6 cups
tetera 6 tazas
100 cl - 33 oz^{13/16}



225358
THÉIÈRE 4 TASSES
tea pot 4 cups
tetera 4 tazas
70 cl - 23 oz^{13/16}

FEUTRE NOIR ISOLANT POUR THÉIÈRE
black tea pot felt
fieltro negro aislante tetera
217133 217132 217131 217130
8 tasses 6 tasses 4 tasses 2 tasses
8 cups 6 cups 4 cups 2 cups
8 tazas 6 tazas 4 tazas 2 tazas



BLANC - WHITE - BLANCO



210946
TASSE CAFÉ
demitasse cup
taza de café
11 cl - 3 oz^{3/4}



210947
TASSE THÉ
coffee/tea cup
taza de té
25 cl - 8 oz^{7/16}



210948
TASSE DÉJEUNER
breakfast cup
taza desayuno
42 cl - 14 oz^{3/16}



210949
MUG À THÉ
tea mug
mug
38 cl - 12 oz^{7/8}

GRIS PERLE - LIGHT GREY

NEW



230145
TASSE CAFÉ
demitasse cup
taza de café
11 cl - 3 oz^{3/4}



230146
TASSE THÉ
coffee/tea cup
taza de té
25 cl - 8 oz^{7/16}



230147
TASSE DÉJEUNER
breakfast cup
taza desayuno
42 cl - 14 oz^{3/16}



230148
MUG À THÉ
tea mug
mug
38 cl - 12 oz^{7/8}

ROSE POUDRÉ - THÉ PINK

NEW



230130
TASSE CAFÉ
demitasse cup
taza de café
11 cl - 3 oz^{3/4}



230131
TASSE THÉ
coffee/tea cup
taza de té
25 cl - 8 oz^{7/16}



230132
TASSE DÉJEUNER
breakfast cup
taza desayuno
42 cl - 14 oz^{3/16}



230133
MUG À THÉ
tea mug
mug
38 cl - 12 oz^{7/8}



210950
SOUCOUBE CAFÉ/THÉ
demitasse/coffee/tea saucer
plato café/té
16 cm - 6 in^{5/16}



210951
SOUCOUBE DÉJEUNER/MUG
breakfast/mug saucer
plato desayuno/mug
18 cm - 7 in^{1/16}



187276
SUCRIER
sugar bowl
azucarero con tapa
28 cl - 9 oz^{2/16}



150475
SUCRIER
sugar bowl
azucarero con tapa
28 cl - 9 oz^{2/16}



187283
CORPS SUCRIER
sugar bowl without lid
azucarero



150469
CORPS SUCRIER
sugar bowl without lid
azucarero



187277
CRÉMIER
cream jug
lechera
15 cl - 5oz^{1/16}



150485
CRÉMIER
cream jug
lechera
15 cl - 5oz^{1/16}



COLLECTION L  **NEW**



 227829
TASSE LUNGO
coffee/tea cup
lungo taza
25 cl - 8 oz^{7/16}

 227828
TASSE ESPRESSO
demitasse cup
espresso taza
10 cl - 3 oz^{3/8}





 227832
SOUCOUBE LUNGO
coffee/tea saucer
lungo plato
15 cm - 5 in^{7/8}

 227831
SOUCOUBE ESPRESSO
demitasse saucer
espresso plato
12,5 cm - 4 in^{5/16}

COLLECTION L FRAGMENT  **NEW**



 227850
SOUCOUBE LUNGO
coffee/tea saucer
lungo plato
15 cm - 5 in^{7/8}

 227849
SOUCOUBE ESPRESSO
demitasse saucer
espresso plato
12,5 cm - 4 in^{5/16}

COLLECTION L

FINEDINING



NEWPORT



207757
TASSE LUNGO
coffee/tea cup
lungo taza
20 cl - 6 oz^{3/4}

207756
TASSE ESPRESSO
demitasse cup
espresso taza
10 cl - 3 oz^{3/8}



207764
VERSEUSE
tea pot
tetera
80 cl - 27 oz^{1/16}

207763
VERSEUSE
tea pot
tetera
40 cl - 13 oz^{1/2}

207762
CREMIER
cream jug
lechera
10 cl - 3 oz^{3/8}



207760
SOUCOUBE LUNGO
coffee/tea saucer
lungo plato
15 cm - 5 in^{7/8}

207759
SOUCOUBE ESPRESSO
demitasse saucer
espresso plato
12,5 cm - 4 in^{5/16}



210912
COUVERCLE VERSEUSE 80 cl - 27 oz^{1/16}
lid for tea pot
tapa cafetera
8,5 cm - 3 in^{3/8}

210911
COUVERCLE VERSEUSE 40 cl - 13 oz^{1/2}
lid for tea pot
tapa cafetera
6,7 cm - 2 in^{5/8}

NEWPORT

FINEDINING



NEWPORT P.136



SMOOS



207766
TASSE ESPRESSO
espresso cup
espresso taza
6 cl - 2 oz



208948
TASSE CAFÉ
demitasse cup
taza de café
11 cl - 3 oz^{3/4}



207767
TASSE THÉ/LUNGO
coffee/tea cup
lungo taza
20 cl - 6 oz^{3/4}



207768
TASSE DÉJEUNER
breakfast cup
taza desayuno
48 cl - 16 oz^{1/4}



207765
MUG
mug
mug
50 cl - 16 oz^{1/8}



209189
MUG
mug
mug
30 cl - 10 oz^{15/16}



161025
SOUCOUBE CAFÉ/ESPRESSO
demitasse/espresso saucer
espresso plato
15 cm - 5 in^{7/8}



161028
SOUCOUBE THÉ/LUNGO
coffee/tea saucer
lungo plato
18 cm - 7 in^{11/16}



161034
SOUCOUBE DÉJEUNER
breakfast saucer
plato desayuno
21 cm - 8 in^{1/4}



214688
SOUCOUBE UNIVERSELLE
universal saucer cup
plato universal
13 cm - 5 in^{1/8}



BAHIA

DUNE - BEIGE DUNE



230929
TASSE ESPRESSO
espresso cup
taza espresso
11 cl - 3 oz^{3/4}



230931
TASSE THÉ
coffee/tea cup
taza de té
20 cl - 6 oz^{3/4}



230930
MUG À THÉ
tea mug
mug
38 cl - 12 oz^{7/8}

BASALTE - BROWN BASALT



230946
TASSE ESPRESSO
espresso cup
taza espresso
11 cl - 3 oz^{3/4}



230948
TASSE THÉ
coffee/tea cup
taza de té
20 cl - 6 oz^{3/4}



230947
MUG À THÉ
tea mug
mug
38 cl - 12 oz^{7/8}

BLEU DE ROCHE - BLUE STONE



230974
TASSE ESPRESSO
espresso cup
taza espresso
11 cl - 3 oz^{3/4}



230976
TASSE THÉ
coffee/tea cup
taza de té
20 cl - 6 oz^{3/4}



230975
MUG À THÉ
tea mug
mug
38 cl - 12 oz^{7/8}

ARGILE VERTE - GREEN CLAY



230960
TASSE ESPRESSO
espresso cup
taza espresso
11 cl - 3 oz^{3/4}



230962
TASSE THÉ
coffee/tea cup
taza de té
20 cl - 6 oz^{3/4}



230961
MUG À THÉ
tea mug
mug
38 cl - 12 oz^{7/8}

ROSE SABLE - PINK SAND



230912
TASSE ESPRESSO
espresso cup
taza espresso
11 cl - 3 oz^{3/4}



230914
TASSE THÉ
coffee/tea cup
taza de té
20 cl - 6 oz^{3/4}



230913
MUG À THÉ
tea mug
mug
38 cl - 12 oz^{7/8}



SMOOS
ALLDAYDINING



NEW BAHIA
ALLDAYDINING



PIERRE DE LAVE - LAVA STONE - PIEDRA DE LAVA **NEW**



194459
TASSE À CAFÉ
demitasse cup
taza de café
11,5 cl - 3 oz^{7/8}



194460
SOUCOUBE À CAFÉ
demitasse saucer
espresso café
12,5 cm - 4 in^{15/16}



230093
TASSE À THÉ
tea cup
taza de tè
25 cl - 6 oz^{3/4}



230094
SOUCOUBE À THÉ
demitasse /tea saucer
plato té
15 cm - 5 oz^{7/8}



194461
MUG À THÉ
mug
tè mug
33 cl - 11 oz^{3/16}

KAOLIN - CAOLÍN



184081
TASSE À CAFÉ
demitasse cup
taza de café
11,5 cl - 3 oz^{7/8}



184082
SOUCOUBE À CAFÉ
demitasse saucer
espresso café
12,5 cm - 4 in^{15/16}



230163
TASSE À THÉ
tea cup
taza de tè
25 cl - 6 oz^{3/4}



230164
SOUCOUBE À THÉ
demitasse /tea saucer
plato té
15 cm - 5 oz^{7/8}



184083
MUG À THÉ
mug
tè mug
33 cl - 11 oz^{3/16}

TERRE D'OMBRE - TAUPE - TIERRA DE SOMBRA



184094
TASSE À CAFÉ
demitasse cup
taza de café
11,5 cl - 3 oz^{7/8}



184095
SOUCOUBE À CAFÉ
demitasse saucer
espresso café
12,5 cm - 4 in^{15/16}



230165
TASSE À THÉ
tea cup
taza de tè
25 cl - 6 oz^{3/4}



230166
SOUCOUBE À THÉ
demitasse /tea saucer
plato té
15 cm - 5 oz^{7/8}



184096
MUG À THÉ
mug
tè mug
33 cl - 11 oz^{3/16}

BLEU GALET - BLUE - AZUL



225351
TASSE À CAFÉ
demitasse cup
taza de café
11,5 cl - 3 oz^{7/8}



225352
SOUCOUBE À CAFÉ
demitasse saucer
espresso café
12,5 cm - 4 in^{15/16}



230167
TASSE À THÉ
tea cup
taza de tè
25 cl - 6 oz^{3/4}



230168
SOUCOUBE À THÉ
demitasse /tea saucer
plato té
15 cm - 5 oz^{7/8}

TOMETTE - RED - ROJO



222022
TASSE À CAFÉ
demitasse cup
taza de café
11,5 cl - 3 oz^{7/8}



222023
SOUCOUBE À CAFÉ
demitasse saucer
espresso café
12,5 cm - 4 in^{15/16}

MODULO NATURE
ALLDAYDINING



LE COUVERT - FLATWARE - CUBIERTOS

Les ateliers DEGRENNE donnent forme aux majestueuses bobines d'acier inoxydable et transforment la matière brute en couverts. Les couverts DEGRENNE bénéficient d'un savoir-faire unique et se caractérisent par une ergonomie et une résistance exceptionnelle. Faciles d'entretien, ils répondent aux critères les plus exigeants de qualité, de fonctionnalité et d'esthétique : la qualité du design et le soin apporté aux finitions font de chacun de nos couverts de véritables pièces d'orfèvre de style classique ou contemporain. Créé en collaboration avec des chefs ou en laissant libre cours à l'imagination de nos designers, aux lignes sobres ou plus élaborées, chaque modèle DEGRENNE trouve sa place à table.

DEGRENNE'S workshops shape the impressive reels of stainless steel and transform the raw material into cutlery. We use our unique expertise to create our cutlery, which is characterized by being extraordinarily easy to use and sturdy. DEGRENNE cutlery is easy to look after and meets the most stringent quality, functionality and appearance criteria. The design quality and painstaking finishes make each of our items of cutlery true pieces of classic or contemporary silverware. DEGRENNE cutlery is designed in partnership with chefs or by giving our designers free rein. Some items have simple lines, while others are more elaborate, but every DEGRENNE design takes pride of place on a table.

Los talleres DEGRENNE dan forma a las majestuosas bobinas de acero inoxidable y transforman la materia bruta en cubiertos. Los cubiertos DEGRENNE se benefician de un saber hacer único y se caracterizan por una ergonomía y una resistencia excepcional. Fáciles de mantener, responden a los criterios más exigentes de calidad, de funcionalidad y de estética : La calidad del diseño y el cuidado aportado a los acabados hacen que cada uno de nuestros cubiertos sea una verdadera pieza de orfebrería de estilo clásico o contemporáneo. Creado en colaboración con chefs o dando rienda suelta a la imaginación de nuestros diseñadores, con líneas sobrias o más elaboradas, cada modelo DEGRENNE encuentra su lugar en la mesa.



GOURMET  P.18

XY  P.76-77



COLLECTIONS COUTEAUX À STEAK KNIVES-CUCHILLOS



Ces couteaux de table régionaux fabriqués à Thiers en France offrent un confort de coupe d'une précision inégalée. À travers cette gamme de couteaux, DEGRENNÉ propose un savoir-faire remarquable né il y a près d'un siècle à Thiers, la capitale française de la coutellerie.

These regional steak knives, made in Thiers, France, offer cutting comfort of incomparable precision. Through this range of knives, DEGRENNÉ offers a remarkable know-how born almost a century ago in Thiers, the French capital of cutlery.

Estos regionales cuchillos steak, fabricados en Thiers, Francia, ofrecen una comodidad de corte de precisión incomparable. A través de esta gama de cuchillos, DEGRENNÉ ofrece un notable saber hacer nacido hace casi un siglo en Thiers, la capital francesa de la cuchillería.





MIRAGE

226261
COUTEAU MIRAGE ANTHRACITE
Mirage knife charcoal grey
 Mirage cuchillo antracita
 23 cm - 9 in^{1/16}



226263
COUTEAU MIRAGE BLANC
Mirage knife white
 Mirage cuchillo blanco
 23 cm - 9 in^{1/16}



THIERS

218289
COUTEAU THIERS INOX FORGÉ
Thiers knife - forged stainless steel
 Thiers cuchillo acero
 23,4 cm - 9 in^{3/16}



232231
COUTEAU THIERS NACRINE
Thiers knife - pearl white
 Thiers cuchillo nacarina
 23 cm - 9 in^{1/16}



232237
COUTEAU THIERS GRIS
Thiers knife - grey
 Thiers cuchillo gris
 23 cm - 9 in^{1/16}



232241
COUTEAU THIERS NOIR MAT
Thiers knife - matt black
 Thiers cuchillo negro mate
 23 cm - 9 in^{1/16}



232239
COUTEAU THIERS OLIVIER
Thiers knife - olive wood
 Thiers cuchillo olivo
 23 cm - 9 in^{1/16}



LAGUIOLE

232249
COUTEAU LAGUIOLE CORNE NOIRE - MITRE INOX
Laguiole knife - horn - steel bolster
 Laguiole cuchillo cuerno - mitra acero
 23 cm - 9 in^{1/16}



232251
COUTEAU LAGUIOLE CORNE CLAIRE - MITRE LAITON
Laguiole knife - light horn - brass bolster
 Laguiole cuchillo cuerno claro - mitra laton
 23 cm - 9 in^{1/16}



232253
COUTEAU LAGUIOLE IVOIRINE - MITRE INOX
Laguiole knife - ivory color - steel bolster
 Laguiole cuchillo - color marfil - mitra acero
 23 cm - 9 in^{1/16}



232255
COUTEAU LAGUIOLE OLIVIER - MITRE LAITON
Laguiole knife - olive wood - brass bolster
 Laguiole cuchillo - olivo - mitra laton
 23 cm - 9 in^{1/16}



CAPUCIN

232243
COUTEAU CAPUCIN NOIR
Capucin knife - black
 Capucin cuchillo negro
 22,6 cm - 8 in^{7/8}



232245
COUTEAU CAPUCIN IVOIRINE
Capucin knife - ivory color
 Capucin cuchillo color marfil
 22,6 cm - 8 in^{7/8}



232247
COUTEAU CAPUCIN ROUGE
Capucin knife - red
 Capucin cuchillo - rojo
 22,6 cm - 8 in^{7/8}





COLLECTIONS
DESIGN



205568
FOURCHETTE DE TABLE
table fork
tenedor mesa
21,3 cm - 8 in^{3/8}



205570
CUILLER CAFÉ
coffee/tea spoon
cuchara café
14,3 cm - 5 in^{5/8}



195028
COUTEAU TABLE MONOBLOC LAME SCIE
table knife solid handle serrated
cuchillo mesa hoja sierra
23,3 cm - 9 in^{3/16}



195034
CUILLER MOKA
demi tasse spoon
cuchara moka
11 cm - 4 in^{5/16}



205569
CUILLER TABLE
table/pasta spoon
cuchara mesa
20,5 cm - 8 in^{1/16}



196674
CUILLER SODA
iced tea spoon
cuchara soda/helado
19 cm - 7 in^{1/2}



200483
CUILLER À SOUPE ANGLAISE
bouillon spoon, round
cuchara consomé
18,5 cm - 7 in^{5/16}



195039
FOURCHETTE MISE EN BOUCHE
cocktail fork
tenedor aperitivo
15,5 cm - 6 in^{1/8}



205575
CUILLER GOURMANDE
dessert /soup spoon, oval
cuchara postre
18,6 cm - 7 in^{5/16}



195042
SPATULE MISE EN BOUCHE
cocktail spatula
espátula aperitivo
15,5 cm - 6 in^{1/8}



205574
FOURCHETTE GOURMANDE
dessert /salad fork
tenedor postre
18,6 cm - 7 in^{5/16}



195041
CUILLER MISE EN BOUCHE
cocktail spoon
cuchara aperitivo
11,6 cm - 4 in^{9/16}



195031
COUTEAU DESSERT MONOBLOC LAME UNIE
dessert knife solid handle
cuchillo postre hoja lisa
20,6 cm - 8 in^{1/8}



196014
FOURCHETTE À HUITRES
oyster fork
tenedor ostras
14,1 cm - 5 in^{9/16}



195036
TARTINEUR
butter spreader
espatulín mantequilla
16 cm - 6 in^{5/16}



199773
FOURCHETTE DE SERVICE
serving fork
tenedor de servicio/ensalada
26 cm - 10 in^{1/4}



205571
FOURCHETTE POISSON
fish fork
tenedor pescado
20 cm - 7 in^{7/8}



199774
CUILLER DE SERVICE
serving spoon
cuchara de servicio/ensalada
26 cm - 10 in^{1/4}



205572
SPATULE GOURMET
gourmet spatula
espátula gourmet
20,2 cm - 7 in^{15/16}



199769
SPATULE DE SERVICE
serving spatula
espátula de servicio
25 cm - 9 in^{13/16}



205573
FOURCHETTE GOURMET
gourmet fork
tenedor gourmet
20 cm - 7 in^{7/8}



199771
SERVICE SALADE
salad serving set
set servicio/ensalada
30 cm - 11 in^{13/16}



205559
FOURCHETTE DE TABLE
table fork
tenedor mesa
21,3 cm - 8 in^{3/8}



181109
CUILLER MOKA
demi tasse spoon
cuchara moka
11 cm - 4 in^{5/16}



193776
COUTEAU TABLE MONOBLOC LAME SCIE
table knife solid handle serrated
cuchillo mesa hoja sierra
23,3 cm - 9 in^{3/16}



190018
CUILLER SODA
iced tea spoon
cuchara soda/helado
19 cm - 7 in^{1/2}



205560
CUILLER TABLE
table/pasta spoon
cuchara mesa
20,5 cm - 8 in^{1/16}



181119
FOURCHETTE MISE EN BOUCHE
cocktail fork
tenedor aperitivo
15,5 cm - 6 in^{1/8}



205561
CUILLER À SOUPE ANGLAISE
bouillon spoon, round
cuchara consomé
18,5 cm - 7 in^{5/16}



181120
SPATULE MISE EN BOUCHE
cocktail spatula
espátula aperitivo
15,5 cm - 6 in^{1/8}



205567
CUILLER GOURMANDE
dessert /soup spoon, oval
cuchara postre
18,6 cm - 7 in^{5/16}



181121
CUILLER MISE EN BOUCHE
cocktail spoon
cuchara aperitivo
11,6 cm - 4 in^{9/16}



205566
FOURCHETTE GOURMANDE
dessert /salad fork
tenedor postre
18,6 cm - 7 in^{5/16}



190424
FOURCHETTE À HUÎTRES
oyster fork
tenedor ostras
14,1 cm - 5 in^{9/16}



181111
COUTEAU DESSERT MONOBLOC LAME UNIE
dessert knife solid handle
cuchillo postre hoja lisa
20,6 cm - 8 in^{1/8}



181114
FOURCHETTE DE SERVICE
serving fork
tenedor de servicio/ensalada
26 cm - 10 in^{1/4}



181112
TARTINEUR
butter spreader
espatulín mantequilla
16 cm - 6 in^{5/16}



181113
CUILLER DE SERVICE
serving spoon
cuchara de servicio/ensalada
26 cm - 10 in^{1/4}



205563
FOURCHETTE POISSON
fish fork
tenedor pescado
20 cm - 7 in^{7/8}



181122
SPATULE DE SERVICE
serving spatula
espátula de servicio
25 cm - 9 in^{13/16}



205564
SPATULE GOURMET
gourmet spatula
espátula gourmet
20,2 cm - 7 in^{15/16}



189999
SERVICE SALADE
salad serving set
set servicio/ensalada
30 cm - 11 in^{13/16}



205565
FOURCHETTE GOURMET
gourmet fork
tenedor gourmet
20 cm - 7 in^{7/8}



153193
LOUCHE
soup ladle
cazo
29,7 cm - 11 in^{1/16}



205562
CUILLER CAFÉ
coffee/tea spoon
cuchara café
14,3 cm - 5 in^{5/8}



154606
LOUCHE À SAUCE
sauce ladle
cazo para salsa
18,5 cm - 7 in^{5/16}



XY MIROIR
FINEDINING



143770
FOURCHETTE DE TABLE
table fork
tenedor mesa
20,9 cm - 8 in^{1/4}



159484
COUTEAU TABLE MONOBLOC LAME SCIE
table knife solid handle serrated
cuchillo mesa hoja sierra
23,2 cm - 9 in^{1/8}



208624
COUTEAU TABLE MONOBLOC LAME SCIE
table knife solid handle serrated
cuchillo mesa hoja sierra
23 cm - 9 in^{1/16}



159451
COUTEAU STEAK MONOBLOC LAME SCIE
solid handle steak knife serrated
cuchillo steak hoja sierra
23,5 cm - 9 in^{1/4}



143767
CUILLER TABLE
table/pasta spoon
cuchara mesa
21,2 cm - 8 in^{3/8}



148852
CUILLER À SOUPE ANGLAISE
bouillon spoon, round
cuchara consomé
17,1 cm - 6 in^{3/4}



143801
CUILLER DESSERT
dessert /soup spoon, oval
cuchara postre
18,7 cm - 7 in^{3/8}



143804
FOURCHETTE DESSERT
dessert /salad fork
tenedor postre
18,4 cm - 7 in^{1/4}



159492
COUTEAU DESSERT MONOBLOC LAME UNIE
dessert knife solid handle
cuchillo postre hoja lisa
20,4 cm - 8 in^{1/16}



208625
COUTEAU DESSERT MONOBLOC LAME SCIE
dessert knife solid handle serrated
cuchillo postre hoja sierra
20,7 cm - 8 in^{1/8}



181112
TARTINEUR
butter spreader
espatulín mantequilla
16 cm - 6 in^{5/16}



143790
FOURCHETTE POISSON
fish fork
tenedor pescado
18,5 cm - 7 in^{15/16}



181467
COUTEAU POISSON/GOURMET
gourmet /fish knife
cuchillo pescado
20,1 cm - 7 in^{15/16}



143772
CUILLER CAFÉ
coffee/tea spoon
cuchara café
14,9 cm - 5 in^{7/8}



148855
CUILLER MOKA
demi tasse spoon
cuchara moka
11 cm - 4 in^{5/16}



190018
CUILLER SODA
iced tea spoon
cuchara soda/helado
19 cm - 7 in^{1/2}



143782
FOURCHETTE GÂTEAUX/COCKTAIL
pastry/cocktail fork
tenedor pastel
14,9 cm - 5 in^{7/8}



190424
FOURCHETTE À HÛÎTRES
oyster fork
tenedor ostras
14,1 cm - 5 in^{7/16}



197522
FOURCHETTE DE SERVICE
serving fork
tenedor de servicio/ensalada
26,6 cm - 10 in^{1/2}



197523
CUILLER DE SERVICE
serving spoon
cuchara de servicio/ensalada
27 cm - 10 in^{5/8}



197525
SERVICE SALADE
salad serving set
set servicio/ensalada
30 cm - 11 in^{13/16}



197527
PELLE À TARTE MONOBLOC
pastry server solid handle
pala para tarta
25,1 cm - 9 in^{7/8}



153193
LOUCHE
soup ladle
cazo
29,7 cm - 11 in^{1/16}



154606
CUILLER À SAUCE
sauce ladle
cazo para salsa
18,5 cm - 7 in^{5/16}



SERENITY
FINEDINING



208624

159484



223482
FOURCHETTE DE TABLE
table fork
tenedor mesa
21,3 cm - 8 in^{9/16}



223487
FOURCHETTE POISSON
fish fork
tenedor pescado
19,2 cm - 7 in^{9/16}



202995
COUPEAU TABLE MONOBLOC LAME SCIE
table knife solid handle serrated
cuchillo mesa hoja sierra
23,2 cm - 9 in^{1/8}



223488
COUPEAU POISSON/GOURMET
gourmet / fish knife
cuchillo pescado
21,3 cm - 8 in^{3/8}



203017
COUPEAU STEAK MONOBLOC LAME SCIE
solid handle steak knife serrated
cuchillo steak hoja sierra
23,2 cm - 9 in^{1/8}



223483
CUILLER CAFÉ
coffee/tea spoon
cuchara café
14,3 cm - 5 in^{5/8}



223481
CUILLER TABLE
table/pasta spoon
cuchara mesa
21,6 cm - 8 in^{1/2}



223484
CUILLER MOKA
demi tasse spoon
cuchara moka
11,7 cm - 4 in^{5/8}



223491
CUILLER À SOUPE ANGLAISE
bouillon spoon, round
cuchara consomé
18,5 cm - 7 in^{7/8}



223492
CUILLER SODA
iced tea spoon
cuchara soda/helado
18,9 cm - 7 in^{7/8}



223486
CUILLER DESSERT
dessert / soup spoon, oval
cuchara postre
19,5 cm - 7 in^{11/16}



223489
FOURCHETTE GÂTEAUX
pastry/cocktail fork
tenedor pastel
13,9 cm - 5 in^{1/2}



223485
FOURCHETTE DESSERT
dessert / salad fork
tenedor postre
19,2 cm - 7 in^{9/16}



223493
FOURCHETTE DE SERVICE
serving fork
tenedor de servicio/ensalada
26,6 cm - 10 in^{1/2}



210630
COUPEAU DESSERT MONOBLOC LAME SCIE
dessert knife solid handle serrated
cuchillo postre hoja sierra
20,9 cm - 8 in^{1/4}



223494
CUILLER DE SERVICE
serving spoon
cuchara de servicio/ensalada
27 cm - 10 in^{5/8}



203016
COUPEAU À BEURRE
butter knife solid handle
cuchillo mantequilla hoja lisa
19,3 cm - 7 in^{5/8}



223496
SERVICE SALADE
salad serving set
set servicio/ensalada
30 cm - 11 in^{13/16}



223497
PELLE À TARTE MONOBLOC
pastry server solid handle
pala para tarta
25,1 cm - 9 in^{7/8}



230848
FOURCHETTE DE TABLE
table fork
 tenedor mesa
 21,3 cm - 8 in^{3/8}



230850
COUTEAU TABLE MONOBLOC LAME SCIE
table knife solid handle serrated
 cuchillo mesa hoja sierra
 23,2 cm - 9 in^{1/8}



230849
CUILLER TABLE
table/pasta spoon
 cuchara mesa
 21,6 cm - 8 in^{1/2}



230854
CUILLER DESSERT
dessert /soup spoon, oval
 cuchara postre
 19,5 cm - 7 in^{11/16}



230853
FOURCHETTE DESSERT
dessert /salad fork
 tenedor postre
 19,2 cm - 7 in^{9/16}



230855
COUTEAU DESSERT MONOBLOC LAME SCIE
dessert knife solid handle serrated
 cuchillo postre hoja sierra
 20,9 cm - 8 in^{1/4}



230851
CUILLER CAFÉ
coffee/tea spoon
 cuchara café
 14,3 cm - 5 in^{5/8}



230852
CUILLER MOKA
demi tasse spoon
 cuchara moka
 11,7 cm - 4 in^{5/8}



197507
FOURCHETTE DE TABLE
table fork
tenedor mesa
21,3 cm - 8 in^{3/8}



197508
CUILLER CAFÉ
coffee/tea spoon
cuchara café
14,3 cm - 5 in^{5/8}



197509
COUTEAU TABLE MONOBLOC LAME SCIE
table knife solid handle serrated
cuchillo mesa hoja sierra
23,2 cm - 9 in^{1/8}



197510
CUILLER MOKA
demi tasse spoon
cuchara moka
11,7 cm - 4 in^{5/8}



197521
COUTEAU STEAK MONOBLOC LAME SCIE
solid handle steak knife serrated
cuchillo steak hoja sierra
23,2 cm - 9 in^{1/8}



190018
CUILLER SODA
iced tea spoon
cuchara soda/helado
19 cm - 7 in^{1/2}



197506
CUILLER TABLE
table/pasta spoon
cuchara mesa
21,6 cm - 8 in^{1/2}



197516
FOURCHETTE GÂTEAUX
pastry/cocktail fork
tenedor pastel
13,9 cm - 5 in^{1/2}



197518
CUILLER À SOUPE ANGLAISE
bouillon spoon, round
cuchara consomé
18,5 cm - 7 in^{5/16}



190424
FOURCHETTE À HUITRES
oyster fork
tenedor ostras
14,1 cm - 5 in^{9/16}



197512
CUILLER DESSERT
dessert /soup spoon, oval
cuchara postre
19,5 cm - 7 in^{11/16}



197522
FOURCHETTE DE SERVICE
serving fork
tenedor de servicio/ensalada
26,6 cm - 10 in^{1/2}



197511
FOURCHETTE DESSERT
dessert /salad fork
tenedor postre
19,2 cm - 7 in^{9/16}



197523
CUILLER DE SERVICE
serving spoon
cuchara de servicio/ensalada
27 cm - 10 in^{5/8}



210629
COUTEAU DESSERT MONOBLOC LAME SCIE
dessert knife solid handle serrated
cuchillo postre hoja sierra
20,9 cm - 8 in^{1/4}



197525
SERVICE SALADE
salad serving set
set servicio/ensalada
30 cm - 11in^{13/16}



197520
COUTEAU À BEURRE MONOBLOC LAME SCIE
butter knife solid handle
cuchillo mantequilla hoja sierra
19,3 cm - 7 in^{5/8}



197527
PELLE À TARTE MONOBLOC
pastry server solid handle
pala para tarta
25,1 cm - 9in^{7/8}



197514
FOURCHETTE POISSON
fish fork
tenedor pescado
19,2 cm - 7 in^{9/16}



153193
LOUCHE
soup ladle
cazo
29,7 cm - 11in^{13/16}



197515
COUTEAU POISSON/GOURMET
gourmet /fish knife
cuchillo pescado
21,3 cm - 8 in^{3/8}



154606
LOUCHE À SAUCE
sauce ladle
caza para salsa
18,5 cm - 7 in^{5/16}



217139
FOURCHETTE DE TABLE
table fork
tenedor mesa
21,3 cm - 8 in^{3/8}



217140
COUTEAU TABLE MONOBLOC LAME SCIE
table knife solid handle serrated
cuchillo mesa hoja sierra
23,2 cm - 9 in^{1/8}



230339
COUTEAU STEAK MONOBLOC LAME SCIE
solid handle steak knife serrated
cuchillo steak hoja sierra
23,2 cm - 9 in^{1/8}



217141
CUILLER TABLE
table/pasta spoon
cuchara mesa
21,6 cm - 8 in^{1/2}



217143
CUILLER DESSERT
dessert /soup spoon, oval
cuchara postre
19,5 cm - 7 in^{11/16}



217144
FOURCHETTE DESSERT
dessert /salad fork
tenedor postre
19,2 cm - 7 in^{9/16}



217145
COUTEAU DESSERT MONOBLOC LAME SCIE
dessert knife solid handle serrated
cuchillo postre hoja sierra
20,9 cm - 8 in^{1/4}



230411
FOURCHETTE POISSON
fish fork
tenedor pescado
19,2 cm - 7 in^{9/16}



230412
COUTEAU POISSON/GOURMET
gourmet /fish knife
cuchillo pescado
21,3 cm - 8 in^{3/8}



217142
CUILLER CAFÉ
coffee/tea spoon
cuchara café
14,3 cm - 5 in^{5/8}



217146
CUILLER MOKA
demi tasse spoon
cuchara moka
11,7 cm - 4 in^{5/8}



232307
TARTINEUR
butter spreader
espatulin mantequilla
16 cm - 6 in^{5/16}



NEW GUEST VINTAGE
FINEDINING



205540
FOURCHETTE DE TABLE
table fork
 tenedor mesa
 20,9 cm - 8 in^{1/4}



159484
COUTEAU TABLE MONOBLOC LAME SCIE
table knife solid handle serrated
 cuchillo mesa hoja sierra
 23,2 cm - 9 in^{1/8}



208624
COUTEAU TABLE MONOBLOC LAME SCIE
solid handle table knife serrated
 cuchillo mesa hoja sierra
 23 cm - 9 in^{1/8}



159451
COUTEAU STEAK MONOBLOC LAME SCIE
solid handle steak knife serrated
 cuchillo steak hoja sierra
 23,5 cm - 9 in^{1/4}



205541
CUILLER TABLE
table/pasta spoon
 cuchara mesa
 20,9 cm - 8 in^{1/4}



205542
CUILLER À SOUPE ANGLAISE
bouillon spoon, round
 cuchara consomé
 17,8 cm - 7 in



205547
CUILLER DESSERT
dessert /soup spoon, oval
 cuchara postre
 18,4 cm - 7 in^{1/4}



205546
FOURCHETTE DESSERT
dessert /salad fork
 tenedor postre
 18,4 cm - 7 in^{1/4}



159492
COUTEAU DESSERT MONOBLOC LAME UNIE
dessert knife solid handle
 cuchillo postre hoja lisa
 20,4 cm - 8 in^{1/8}



208625
COUTEAU DESSERT MONOBLOC LAME SCIE
dessert knife solid handle serrated
 cuchillo postre hoja sierra
 20,7 cm - 8 in^{1/8}



154612
COUTEAU À BEURRE MONOBLOC LAME UNIE
butter knife solid handle
 cuchillo mantequilla hoja lisa
 19,4 cm - 7 in^{5/8}



205544
FOURCHETTE POISSON
fish fork
 tenedor pescado
 18,4 cm - 7 in^{1/4}



205545
COUTEAU POISSON/GOURMET
gourmet /fish knife
 cuchillo pescado
 20,7 cm - 8 in^{1/8}



205543
CUILLER CAFÉ
coffee/tea spoon
 cuchara café
 14 cm - 5 in^{1/2}



159512
CUILLER MOKA
demi tasse spoon
 cuchara moka
 11,1 cm - 4 in^{3/8}



190018
CUILLER SODA
iced tea spoon
 cuchara soda/helado
 19 cm - 7 in^{1/2}



205548
FOURCHETTE GÂTEAUX/COCKTAIL
pastry/cocktail fork
 tenedor pastel
 14,3 cm - 5 in^{5/8}



190424 - FOURCHETTE À HUÎTRES
oyster fork
 tenedor ostras
 14,1 cm - 5 in^{9/16}



159501
FOURCHETTE DE SERVICE
servicing fork
 tenedor de servicio/ensalada
 26 cm - 10 in^{1/4}



159500
CUILLER DE SERVICE
servicing spoon
 cuchara de servicio/ensalada
 26 cm - 10 in^{1/4}



159504
SERVICE SALADE
salad serving set
 set servicio/ensalada
 30 cm - 11 in^{13/16}

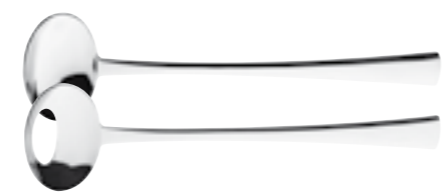

159490
PELLE À TARTE MONOBLOC
pastry server solid handle
 pala para tarta
 26,2 cm - 10 in^{5/16}



153193
LOUCHE
soup ladle
 cazo
 29,7 cm - 11 in^{11/16}



154606
LOUCHE À SAUCE
sauce ladle
 cazo para salsa
 18,5 cm - 7 in^{5/16}



SOLSTICE MIROIR
 ALLDAY DINING



208624

159484



126355
FOURCHETTE DE TABLE
table fork
tenedor mesa
20,1 cm - 7 in^{5/16}



126377
FOURCHETTE POISSON
fish fork
tenedor pescado
17,7 cm - 6 in^{5/16}



210731
COUTEAU TABLE MONOBLOC LAME SCIE
table knife solid handle serrated
cuchillo mesa hoja sierra
23,5 cm - 9 in^{1/4}



181181
COUTEAU POISSON/GOURMET
gourmet / fish knife
cuchillo pescado
20,1 cm - 7 in^{5/16}



207189
COUTEAU STEAK MONOBLOC LAME SCIE
solid handle steak knife serrated
cuchillo steak hoja sierra
23,6 cm - 9 in^{5/16}



126358
CUILLER CAFÉ
coffee/tea spoon
cuchara café
13,7 cm - 5 in^{3/8}



126352
CUILLER TABLE
table/pasta spoon
cuchara mesa
20,3 cm - 8 in



140852
CUILLER MOKA
demi tasse spoon
cuchara moka
11 cm - 4 in^{5/16}



140855
CUILLER À SOUPE ANGLAISE
bouillon spoon, round
cuchara consomé
17,9 cm - 7 in^{1/16}



189973
CUILLER SODA
iced tea spoon
cuchara soda/helado
19 cm - 7 in^{1/2}



126368
CUILLER DESSERT
dessert / soup spoon, oval
cuchara postre
17,8 cm - 7 in



126383
FOURCHETTE GÂTEAUX/COCKTAIL
pastry/cocktail fork
tenedor pastel
13,7 cm - 5 in^{3/8}



126371
FOURCHETTE DESSERT
dessert / salad fork
tenedor postre
17,7 cm - 6 in^{5/16}



189974
FOURCHETTE À HUÎTRES
oyster fork
tenedor ostras
13,3 cm - 5 in^{1/4}



210732
COUTEAU DESSERT MONOBLOC LAME UNIE
dessert knife solid handle
cuchillo postre hoja lisa
20,7 cm - 8 in^{1/8}



231218
FOURCHETTE DE SERVICE
serving fork
tenedor de servicio/ensalada
26,6 cm - 10 in^{1/2}



189971
COUTEAU À BEURRE MONOBLOC LAME UNIE
butter knife solid handle
cuchillo mantequilla hoja lisa
18,9 cm - 7 in^{7/16}



231219
CUILLER DE SERVICE
serving spoon
cuchara de servicio/ensalada
26,6 cm - 10 in^{1/2}



231221
PELLE À TARTE MONOBLOC
pastry server solid handle
pala para tarta
25,2 cm - 9 in^{5/16}



231220
LOUCHE
soup ladle
cazo
29 cm - 11 in^{7/16}



153998
FOURCHETTE DE TABLE
table fork
tenedor mesa
20,7 cm - 8 in^{7/8}



154558
FOURCHETTE POISSON
fish fork
tenedor pescado
18,7 cm - 7 in^{3/8}



154002
COUTEAU TABLE MONOBLOC LAME SCIE
table knife solid handle serrated
cuchillo mesa hoja sierra
23,5 cm - 9 in^{1/4}



154561
COUTEAU POISSON/GOURMET
gourmet /fish knife
cuchillo pescado
21,1 cm - 8 in^{15/16}



199761
COUTEAU STEAK MONOBLOC LAME SCIE
solid handle steak knife serrated
cuchillo steak hoja sierra
22,8 cm - 9 in



154001
CUILLER CAFÉ
coffee/tea spoon
cuchara café
14,1 cm - 5 in^{9/16}



153996
CUILLER TABLE
table/pasta spoon
cuchara mesa
20,7 cm - 8 in^{7/8}



154577
CUILLER MOKA
demi tasse spoon
cuchara moka
11,1 cm - 4 in^{3/8}



190015
CUILLER À SOUPE ANGLAISE
bouillon spoon, round
cuchara consomé
18,3 cm - 7 in^{3/16}



190016
CUILLER SODA
iced tea spoon
cuchara soda/helado
19 cm - 7 in^{1/2}



154571
CUILLER DESSERT
dessert /soup spoon, oval
cuchara postre
18,6 cm - 7 in^{5/16}



154547
FOURCHETTE GÂTEAUX/COCKTAIL
pastry/cocktail fork
tenedor pastel
14 cm - 5 in^{1/2}



154574
FOURCHETTE DESSERT
dessert /salad fork
tenedor postre
18,6 cm - 7 in^{5/16}



154563
FOURCHETTE DE SERVICE
serving fork
tenedor de servicio/ensalada
25,1 cm - 9 in^{7/8}



154555
COUTEAU DESSERT MONOBLOC LAME SCIE
dessert knife solid handle serrated
cuchillo postre hoja sierra
21,1 cm - 8 in^{5/16}



154562
CUILLER DE SERVICE
serving spoon
cuchara de servicio/ensalada
25,5 cm - 10 in^{1/16}



154580
COUTEAU À BEURRE MONOBLOC LAME UNIE
butter knife solid handle
cuchillo mantequilla hoja lisa
19,4 cm - 7 in^{5/8}



154566
SERVICE SALADE
salad serving set
set servicio/ensalada
24,3 cm - 9 in^{9/16}



154552
PELLE À TARTE MONOBLOC
pastry server solid handle
pala para tarta
25,3 cm - 9 in^{15/16}



154550
LOUCHE
soup ladle
cazo
29,7 cm - 11 in^{11/16}



154568
LOUCHE À SAUCE
sauce ladle
cazo para salsa
18,5 cm - 7 in^{5/16}



153188
FOURCHETTE DE TABLE
table fork
tenedor mesa
20,7 cm - 8 in^{7/8}



153196
COUTEAU TABLE MONOBLOC LAME SCIE
table knife solid handle serrated
cuchillo mesa hoja sierra
23,5 cm - 9 in^{1/4}



122418
COUTEAU STEAK MONOBLOC LAME SCIE
solid handle steak knife serrated
cuchillo steak hoja sierra
22,1 cm - 8 in^{11/16}



153185
CUILLER TABLE
table/pasta spoon
cuchara mesa
20,7 cm - 8 in^{7/8}



184758
CUILLER À SOUPE ANGLAISE
bouillon spoon, round
cuchara consomé
18,3 cm - 7 in^{3/16}



153209
CUILLER DESSERT
dessert /soup spoon, oval
cuchara postre
18,6 cm - 7 in^{5/16}



153212
FOURCHETTE DESSERT
dessert /salad fork
tenedor postre
18,6 cm - 7 in^{5/16}



153200
COUTEAU DESSERT MONOBLOC LAME SCIE
dessert knife solid handle serrated
cuchillo postre hoja sierra
21,1 cm - 8 in^{5/16}



154612
COUTEAU À BEURRE MONOBLOC LAME UNIE
butter knife solid handle
cuchillo mantequilla hoja lisa
19,4 cm - 7 in^{5/8}



153203
FOURCHETTE POISSON
fish fork
tenedor pescado
18,7 cm - 7 in^{3/8}



153206
COUTEAU POISSON/GOURMET
gourmet /fish knife
cuchillo pescado
21,1 cm - 8 in^{15/16}



153191
CUILLER CAFÉ
coffee/tea spoon
cuchara café
14,1 cm - 5 in^{9/16}



154609
CUILLER MOKA
demi tasse spoon
cuchara moka
11,1 cm - 4 in^{3/8}



190018
CUILLER SODA
iced tea spoon
cuchara soda/helado
19 cm - 7 in^{1/2}



197516
FOURCHETTE GÂTEAUX/COCKTAIL
pastry/cocktail fork
tenedor pastel
13,9 cm - 5 in^{1/2}



190424
FOURCHETTE À HUITRES
oyster fork
tenedor ostras
14,1 cm - 5 in^{9/16}



162728
FOURCHETTE/PIQUE À ESCARGOTS/COCKTAIL
cocktail, snail fork
tenedor caracoles/cocktail
10,8 cm - 4 in^{1/4}



162730
CURETTE À CRUSTACÉ
seafood scraper
rasqueta para cangrejo
19,1 cm - 7 in^{1/2}



197522
FOURCHETTE DE SERVICE
serving fork
tenedor de servicio/ensalada
26,6 cm - 10 in^{1/2}



197523
CUILLER DE SERVICE
serving spoon
cuchara de servicio/ensalada
27 cm - 10 in^{5/8}



197525
SERVICE SALADE
salad serving set
set servicio/ensalada
30 cm - 11 in^{13/16}



197527
PELLE À TARTE MONOBLOC
pastry server solid handle
pala para tarta
25,1 cm - 9 in^{7/8}



153193
LOUCHE
soup ladle
cazo
29,7 cm - 11 in^{11/16}



154606
LOUCHE À SAUCE
sauce ladle
cazo para salsa
18,5 cm - 7 in^{5/16}



226167
FOURCHETTE DE TABLE
table fork
tenedor mesa
21 cm - 8 in^{1/4}



226170
CUILLER MOKA
demi tasse spoon
cuchara moka
11,6 cm - 4 in^{9/16}



226177
COUTEAU TABLE MONOBLOC LAME SCIE N°1
table knife solid handle serrated n°1
cuchillo mesa hoja sierra n°1
22,8 cm - 9 in



226175
CUILLER SODA
iced tea spoon
cuchara soda/helado
19 cm - 7 in^{1/2}



226176
COUTEAU TABLE MONOBLOC LAME SCIE N°2
table knife solid handle serrated n°2
cuchillo mesa hoja sierra n°2
22,8 cm - 9 in



226174
FOURCHETTE GÂTEAUX/COCKTAIL
pastry/cocktail fork
tenedor pastel
14,5 cm - 5 in^{11/16}



226168
CUILLER TABLE
table/pasta spoon
cuchara mesa
21 cm - 8 in^{1/4}



190424
FOURCHETTE À HUÎTRES
oyster fork
tenedor ostras
14,1 cm - 5 in^{9/16}



226172
CUILLER DESSERT
dessert /soup spoon, oval
cuchara postre
18,9 cm - 7 in^{7/16}



197522
FOURCHETTE DE SERVICE
serving fork
tenedor de servicio/ensalada
26,6 cm - 10 in^{1/2}



226171
FOURCHETTE DESSERT
dessert /salad fork
tenedor postre
18,9 cm - 7 in^{7/16}



197523
CUILLER DE SERVICE
serving spoon
cuchara de servicio/ensalada
27 cm - 10 in^{5/8}



226179
COUTEAU DESSERT MONOBLOC LAME UNIE N°1
dessert knife solid handle n°1
cuchillo postre hoja lisa n°1
20,5 cm - 8 in^{1/16}



197525
SERVICE SALADE
salad serving set
set servicio/ensalada
30 cm - 11 in^{13/16}



226178
COUTEAU DESSERT MONOBLOC LAME UNIE N°2
dessert knife solid handle n°2
cuchillo postre hoja lisa n°2
20,5 cm - 8 in^{1/16}



197527
PELLE À TARTE MONOBLOC
pastry server solid handle
pala para tarta
25,1 cm - 9 in^{7/8}



226171
FOURCHETTE POISSON
fish fork
cuchillo pescado
18,9 cm - 7 in^{7/16}



153193
LOUCHE
soup ladle
cazo
29,7 cm - 11 in^{11/16}



226173
COUTEAU POISSON/GOURMET
gourmet/fish knife
cuchillo pescado
21 cm - 8 in^{1/4}



154606
LOUCHE À SAUCE
sauce ladle
cazo para salsa
18,5 cm - 7 in^{5/16}



226169
CUILLER CAFÉ
coffee/tea spoon
cuchara café
14,5 cm - 5 in^{11/16}



226177

226176



163580
FOURCHETTE DE TABLE
table fork
tenedor mesa
20,9 cm - 8 in^{1/4}



163581
CUILLER CAFÉ
coffee/tea spoon
cuchara café
14,3 cm - 5 in^{5/8}



189969
COUTEAU TABLE MONOBLOC LAME SCIE
table knife solid handle serrated
cuchillo mesa hoja sierra
22,9 cm - 9 in



164715
CUILLER MOKA/TOUILLETTE
demi tasse spoon
cuchara moka
11 cm - 4 in^{5/16}



207189
COUTEAU STEAK MONOBLOC LAME SCIE
solid handle steak knife serrated
cuchillo steak hoja sierra
23,6 cm - 9 in^{5/16}



189973
CUILLER SODA
iced tea spoon
cuchara soda/helado
19 cm - 7 in^{1/2}



163579
CUILLER TABLE
table/pasta spoon
cuchara mesa
21,1 cm - 8 in^{5/16}



164705
FOURCHETTE GÂTEAUX/COCKTAIL
pastry/cocktail fork
tenedor pastel
14,4 cm - 5 in^{11/16}



164713 - CUILLER DESSERT
dessert /soup spoon, oval
cuchara postre
19 cm - 7 in^{1/2}



189974
FOURCHETTE À HUÎTRES
oyster fork
tenedor ostras
13,3 cm - 5 in^{1/4}



164714
FOURCHETTE DESSERT
dessert /salad fork
tenedor postre
18,9 cm - 7 in^{7/16}



162728
FOURCHETTE/PIQUE À ESCARGOTS/COCKTAIL
cocktail, snail fork
tenedor caracoles/cocktail
10,8 cm - 4 in^{1/4}



210627
COUTEAU DESSERT MONOBLOC LAME SCIE
dessert knife solid handle serrated
cuchillo postre hoja sierra
20,6 cm - 8 in^{1/8}



162730
CURETTE À CRUSTACÉ
seafood scraper
rasqueta para cangrejo
19,1 cm - 7 in^{1/2}



189971
COUTEAU À BEURRE MONOBLOC LAME UNIF
butter knife solid handle
cuchillo mantequilla hoja lisa
18,9 cm - 7 in^{7/16}



231218
FOURCHETTE DE SERVICE
serving fork
tenedor de servicio/ensalada
26,6 cm - 10 in^{1/2}



164708
FOURCHETTE POISSON
fish fork
tenedor pescado
18,9 cm - 7 in^{7/16}



231219
CUILLER DE SERVICE
serving spoon
cuchara de servicio/ensalada
26,6 cm - 10 in^{1/2}



164709
COUTEAU POISSON/GOURMET
gourmet/fish knife
cuchillo pescado
21 cm - 8 in^{1/4}



231221
PELLE À TARTE MONOBLOC
pastry server solid handle
pala para tarta
25,2 cm - 9 in^{15/16}



231220
LOUCHE
soup ladle
cazo
29 cm - 11 in^{7/16}



CARBONE - CARBON - CARBONO

205883
FOURCHETTE DE TABLE
table fork
tenedor mesa
21,6 cm - 8 in^{1/2}



CÈPE - TAUPE - TOPO

226787
FOURCHETTE DE TABLE
table fork
tenedor mesa
21,6 cm - 8 in^{1/2}



205885
COUTEAU TABLE /STEAK LAME SCIE
steak/table knife serrated
cuchillo steak hoja sierra
23 cm - 9 in^{1/16}



226789
COUTEAU TABLE /STEAK LAME SCIE
steak/table knife serrated
cuchillo steak hoja sierra
23 cm - 9 in^{1/16}



205884
CUILLER TABLE
table/pasta spoon
cuchara mesa
21,8 cm - 8 in^{9/16}



226788
CUILLER TABLE
table/pasta spoon
cuchara mesa
21,8 cm - 8 in^{9/16}



205886
CUILLER CAFÉ
coffee/tea spoon
cuchara café
15,2 cm - 6 in



226790
CUILLER CAFÉ
coffee/tea spoon
cuchara café
15,2 cm - 6 in



ROUGE - RED - ROJO

206782
FOURCHETTE DE TABLE
table fork
tenedor mesa
21,6 cm - 8 in^{1/2}



BLEU MARIN - STEEL BLUE - AZUL MARINO

226772
FOURCHETTE DE TABLE
table fork
tenedor mesa
21,6 cm - 8 in^{1/2}



205894
COUTEAU TABLE /STEAK LAME SCIE
steak/table knife serrated
cuchillo steak hoja sierra
23 cm - 9 in^{1/16}



226774
COUTEAU TABLE /STEAK LAME SCIE
steak/table knife serrated
cuchillo steak hoja sierra
23 cm - 9 in^{1/16}



206783
CUILLER TABLE
table/pasta spoon
cuchara mesa
21,8 cm - 8 in^{9/16}



226773
CUILLER TABLE
table/pasta spoon
cuchara mesa
21,8 cm - 8 in^{9/16}



206784
CUILLER CAFÉ
coffee/tea spoon
cuchara café
15,2 cm - 6 in



226775
CUILLER CAFÉ
coffee/tea spoon
cuchara café
15,2 cm - 6 in



BLANC - WHITE - BLANCO

210661
FOURCHETTE DE TABLE
table fork
tenedor mesa
21,6 cm - 8 in^{1/2}



ATOLL - TEAL - VERDE AZULADO

226767
FOURCHETTE DE TABLE
table fork
tenedor mesa
21,6 cm - 8 in^{1/2}



210658
COUTEAU TABLE /STEAK LAME SCIE
steak/table knife serrated
cuchillo steak hoja sierra
23 cm - 9 in^{1/16}



226769
COUTEAU TABLE /STEAK LAME SCIE
steak/table knife serrated
cuchillo steak hoja sierra
23 cm - 9 in^{1/16}



210660
CUILLER TABLE
table/pasta spoon
cuchara mesa
21,8 cm - 8 in^{9/16}



226768
CUILLER TABLE
table/pasta spoon
cuchara mesa
21,8 cm - 8 in^{9/16}



210662
CUILLER CAFÉ
coffee/tea spoon
cuchara café
15,2 cm - 6 in



226770
CUILLER CAFÉ
coffee/tea spoon
cuchara café
15,2 cm - 6 in



159451
COUTEAU STEAK MONOBLOC LAME SCIE - GOURMET
steak knife solid handle serrated
cuchillo steak hoja sierra
23,5 cm - 9 in^{1/4}



122418
COUTEAU STEAK MONOBLOC LAME SCIE - GRILLADE
steak knife solid handle serrated
cuchillo steak hoja sierra
22,1 cm - 8 in^{11/16}



162724
CUILLER À AGRUMES
citrus fruits spoon
cuchara para pomelo
15,3 cm - 6 in



190018
CUILLER SODA
iced tea spoon
cuchara soda/helado
19 cm - 7 in^{1/2}



189973
CUILLER SODA
iced tea spoon
cuchara soda/helado
19 cm - 7 in^{1/2}



226175
CUILLER SODA
iced tea spoon
cuchara soda/helado
19 cm - 7 in^{1/2}



154612
COUTEAU À BEURRE
butter knife
espatula mantequilla hoja lisa
19,4 cm - 7 in^{5/8}



189971
COUTEAU À BEURRE
butter knife
espatula mantequilla hoja lisa
19,4 cm - 7 in^{5/8}



190424
FOURCHETTE À HÙITRES
oyster fork
tenedor ostras
14,5 cm - 5 in^{9/16}



189974
FOURCHETTE À HÙITRES
oyster fork
tenedor ostras
14,5 cm - 5 in^{9/16}



162728
FOURCHETTE/PIQUE À ESCARGOTS/COCKTAIL
cocktail, snail fork
tenedor caracoles/cocktail
10,8 cm - 4 in^{1/4}



162730
CURETTE À CRUSTACÉS
seafood scraper
rasqueta para cangrejo
19,1 cm - 7 in^{1/2}



184492
PINCE À CRUSTACÉS
seafood cracker
tenacillas para crustáceos
16,5 cm - 6 in^{1/2}



204497 101493
PINCE À HOMARD
lobster craker
tenacillas para bogavante
18,5 cm - 7 in^{5/16}



004013
PINCE À ESCARGOTS
snail tong
pinzas caracoles
16 cm - 6 in^{5/16}



204499 184355
PINCE À SERVIR
serving tong
pinzas para servir
29,5 cm - 11 in^{5/8}



204498 101492
PINCE À PAIN
bread tong
pinzas pan
23 cm - 9 in^{1/16}



204496 101494
CISEAUX À GÂTEAUX
pastry scissors/tong
pinzas para pasteles
20 cm - 7 in^{7/8}



207257
FOURCHETTE DESSERT
dessert/salad fork
tenedor postre
16,5 cm - 6 in^{1/2}



207259
COUTEAU DESSERT MONOBLOC LAME UNIE
dessert knife solid handle
cuchillo postre hoja lisa
17,7 cm - 6 in^{15/16}



207258
CUILLER DESSERT
dessert/soup spoon, oval
cuchara postre
16,5 cm - 6 in^{1/2}



207256
CUILLER CAFÉ
coffee/tea spoon
cuchara café
13,2 cm - 5 in^{3/16}



Des lignes douces et une taille adaptée aux mains des enfants pour faire de leur repas un moment exquis

Soft lines and a child-friendly size to make children's mealtimes a magic moment

Líneas suaves y un tamaño adaptado a las manos de los niños para convertir la comida en un momento exquisito





COLLECTIONS
CLASSIQUES



126556
FOURCHETTE DE TABLE
table fork
tenedor mesa
20,2 cm - 7 in^{15/16}



126578
FOURCHETTE POISSON
fish fork
tenedor pescado
18 cm - 7 in^{1/16}



126565
COUTEAU TABLE MONOCOQUE/MANCHE ORFÈVRE LAME UNIE
table knife hollow handle
cuchillo mesa enmangado hoja lisa
23 cm - 9 in^{1/16}



126581
COUTEAU POISSON
fish knife
cuchillo pescado
20,1 cm - 7 in^{15/16}



130332
COUTEAU TABLE MONOCOQUE/MANCHE ORFÈVRE LAME SCIE
table knife hollow handle serrated
cuchillo mesa enmangado hoja sierra
23 cm - 9 in^{1/16}



126559
CUILLER CAFÉ
coffee/tea spoon
cuchara café
13,9 cm - 5 in^{1/2}



126553
CUILLER TABLE
table/pasta spoon
cuchara mesa
20,5 cm - 8 in^{1/16}



155452
CUILLER MOKA
demi tasse spoon
cuchara moka
11,1 cm - 4 in^{3/8}



126569
CUILLER DESSERT
dessert /soup spoon, oval
cuchara postre
18 cm - 7 in^{1/16}



126591
FOURCHETTE DE SERVICE
serving fork
tenedor de servicio/ensalada
24,8 cm - 9 in^{3/4}



126572
FOURCHETTE DESSERT
dessert /salad fork
tenedor postre
18 cm - 7 in^{1/16}



126589
CUILLER DE SERVICE
serving spoon
cuchara de servicio/ensalada
25 cm - 9 in^{13/16}



126575
COUTEAU DESSERT MONOCOQUE/MANCHE ORFÈVRE LAME UNIE
dessert knife hollow handle
cuchillo postre enmangado hoja lisa
20,5 cm - 8 in^{1/16}



126587
PELLE À TARTE MANCHE ORFÈVRE
pastry server hollow handle
pala para tarta enmangado
24 cm - 9 in^{7/16}



154828
COUTEAU À BEURRE MONOCOQUE/MANCHE ORFÈVRE LAME UNIE
butter knife hollow handle
cuchillo mantequilla enmangado hoja lisa
18,8 cm - 7 in^{3/8}



126562
LOUCHE
soup ladle
cazo
29,7 cm - 11 in^{11/16}



126595
LOUCHE À SAUCE
sauce ladle
cazo para salsa
17 cm - 6 in^{11/16}



126077
FOURCHETTE DE TABLE
table fork
tenedor mesa
20,8 cm - 8 in^{3/16}



190417
COUTEAU À BEURRE MONOBLOC LOURD MANCHE DROIT LAME UNIE
butter knife straight and heavy solid handle
cuchillo mantequilla pesado recto mango hoja lisa
18,7 cm - 7 in^{3/8}



190643
COUTEAU TABLE MONOBLOC LOURD/MANCHE DROIT LAME SCIE
table knife straight and heavy solid handle serrated
cuchillo mesa pesado recto mango
hoja sierra - 24,6 cm - 9 in^{11/16}



129344
COUTEAU À BEURRE MONOCOQUE/ MANCHE DROIT LAME UNIE
butter knife straight hollow handle
cuchillo mantequilla recto mango enmangado hoja lisa
18,7 cm - 7 in^{3/8}



130140
COUTEAU TABLE MONOCOQUE/MANCHE ORFÈVRE DROIT LAME SCIE
table knife straight hollow handle serrated
cuchillo mesa enmangado recto mango
hoja sierra - 24,6 cm - 9 in^{11/16}



126099
FOURCHETTE POISSON
fish fork
tenedor pescado
17,7 cm - 6 in^{15/16}



127654
COUTEAU STEAK MONOCOQUE/MANCHE ORFÈVRE DROIT LAME SCIE
steak knife straight hollow handle serrated
cuchillo steak enmangado recto mango
hoja sierra - 23,9 cm - 9 in^{7/16}



126102
COUTEAU POISSON
fish knife
cuchillo pescado
19,9 cm - 7 in^{13/16}



126074
CUILLER TABLE
table/pasta spoon
cuchara mesa
20,8 cm - 8 in^{3/16}



129958
CUILLER À SAUCE GOURMET
gourmet/sauce spoon
cuchara para salsa
17,9 cm - 7 in^{1/16}



127651
CUILLER À SOUPE ANGLAISE
bouillon spoon, round
cuchara consommé
17,4 cm - 6 in^{7/8}



126080
CUILLER CAFÉ
coffee/tea spoon
cuchara café
14 cm - 5 in^{1/2}



126090
CUILLER DESSERT
dessert /soup spoon, oval
cuchara postre
18 cm - 7 in^{1/16}



126105
CUILLER MOKA
demi tasse spoon
cuchara moka
11 cm - 4 in^{5/16}



126093
FOURCHETTE DESSERT
dessert /salad fork
tenedor postre
17,8 cm - 7 in



130146
CUILLER SODA
iced tea spoon
cuchara soda/helado
18,2 cm - 7 in^{3/16}



190644
COUTEAU DESSERT MONOBLOC LOURD/MANCHE DROIT LAME SCIE
dessert knife straight and heavy solid handle serrated
cuchillo postre pesado recto mango hoja sierra
20,5 cm - 8 in^{1/16}



126108
FOURCHETTE GÂTEAUX/COCKTAIL
pastry cocktail fork
tenedor pastel
13,8 cm - 5 in^{7/16}



126096
COUTEAU DESSERT MONOCOQUE/MANCHE ORFÈVRE LAME UNIE
dessert knife straight hollow handle
cuchillo postre recto mango enmangado hoja lisa
20,5 cm - 8 in^{1/16}



190418
FOURCHETTE À HÙÎTRES
oyster fork
tenedor ostras
13 cm - 5 in^{1/8}



PIÉCES DE SERVICE
SERVING PIECES
VERLAINE
P 116-117



182968
FOURCHETTE DE TABLE
table fork
tenedor mesa
20,8 cm - 8 in^{3/16}



182972
FOURCHETTE POISSON
fish fork
tenedor pescado
17,7 cm - 6 in^{15/16}



182970
COUTEAU TABLE MONOCOQUE/MANCHE ORFÈVRE LAME SCIE
table knife hollow handle serrated
cuchillo mesa enmangado hoja sierra
24,6 cm - 9 in^{11/16}



182973
COUTEAU POISSON
fish knife
cuchillo pescado
19,9 cm - 7 in^{13/16}



186278
COUTEAU STEAK MONOCOQUE/MANCHE ORFÈVRE LAME SCIE
steak knife hollow handle serrated
cuchillo steak enmangado hoja sierra
23,9 cm - 9 in^{7/16}



186277
CUILLER À SAUCE GOURMET
gourmet/sauce spoon
cuchara para salsa
17,9 cm - 7 in^{1/16}



182967
CUILLER TABLE
table/pasta spoon
cuchara mesa
20,8 cm - 8 in^{3/16}



182969
CUILLER CAFÉ
coffee/tea spoon
cuchara café
14 cm - 5 in^{1/2}



186276
CUILLER À SOUPE ANGLAISE
bouillon spoon, round
cuchara consomé
17,4 cm - 6 in^{7/8}



182976
CUILLER MOKA
demi tasse spoon
cuchara moka
11 cm - 4 in^{5/16}



182974
CUILLER DESSERT
dessert /soup spoon, oval
cuchara postre
18 cm - 7 in^{1/16}



186275
CUILLER SODA
iced tea spoon
cuchara soda/helado
18,2 cm - 7 in^{3/16}



182975
FOURCHETTE DESSERT
dessert /salad fork
tenedor postre
17,8 cm - 7 in



186274
FOURCHETTE GÂTEAUX/COCKTAIL
pastry cocktail fork
tenedor pastel
13,8 cm - 5 in^{7/16}



182971
COUTEAU DESSERT MONOCOQUE/MANCHE ORFÈVRE LAME UNIE
dessert knife hollow handle
cuchillo postre enmangado hoja lisa
20,5 cm - 8 in^{1/16}



190681
FOURCHETTE À HÛTRES
oyster fork
tenedor ostras
13 cm - 5 in^{1/8}



186279
COUTEAU À BEURRE MONOCOQUE/MANCHE ORFÈVRE LAME UNIE
butter knife hollow handle
cuchillo mantequilla enmangado hoja lisa
18,7 cm - 7 in^{3/8}



183803
FOURCHETTE DE SERVICE
serving fork
tenedor de servicio/ensalada
24,8 cm - 9 in^{3/4}



183802
CUILLER DE SERVICE
serving spoon
cuchara de servicio/ensalada
25 cm - 9 in^{13/16}



127442
FOURCHETTE DE TABLE
table fork
tenedor mesa
20,8 cm - 8 in^{3/16}



226578
COUTEAU TABLE MONOBLOC LOURD LAME SCIE
table knife heavy solid handle serrated
cuchillo mesa pesado hoja sierra
24,4 cm - 9 in^{5/8}



139158
COUTEAU TABLE MONOCOQUE/MANCHE ORFÈVRE LAME SCIE
table knife hollow handle serrated
cuchillo mesa enmangado hoja sierra
24,6 cm - 9 in^{11/16}



128841
COUTEAU STEAK MONOCOQUE/MANCHE ORFÈVRE LAME SCIE
steak knife hollow handle serrated
cuchillo steak enmangado hoja sierra
23,9 cm - 9 in^{7/16}



127439
CUILLER TABLE
table/pasta spoon
cuchara mesa
20,8 cm - 8 in^{3/16}



130273
CUILLER À SOUPE ANGLAISE
bouillon spoon, round
cuchara consomé
17,4 cm - 6 in^{7/8}



127464
CUILLER DESSERT
dessert/soup spoon, oval
cuchara postre
18 cm - 7 in^{1/16}



127467
FOURCHETTE DESSERT
dessert/salad fork
tenedor postre
17,8 cm - 7 in



226579
COUTEAU DESSERT MONOBLOC LOURD LAME UNIE
dessert knife heavy solid handle
cuchillo postre pesado hoja lisa
21,1 cm - 8 in^{5/16}



127470
COUTEAU DESSERT MONOCOQUE/MANCHE ORFÈVRE LAME UNIE
dessert knife hollow handle
cuchillo postre enmangado hoja lisa
20,5 cm - 8 in^{1/16}



226580
COUTEAU À BEURRE MONOBLOC LOURD LAME UNIE
butter knife heavy solid handle
cuchillo mantequilla pesado hoja lisa
19 cm - 7 in^{1/2}



122769
COUTEAU À BEURRE MONOCOQUE/MANCHE ORFÈVRE LAME UNIE
butter knife hollow handle
cuchillo mantequilla enmangado hoja lisa
18,7 cm - 7 in^{3/8}



127473
FOURCHETTE POISSON
fish fork
tenedor pescado
17,7 cm - 6 in^{15/16}



127477
COUTEAU POISSON
fish knife
cuchillo pescado
19,9 cm - 7 in^{13/16}



130542
CUILLER À SAUCE GOURMET
gourmet/sauce spoon
cuchara para salsa
17,9 cm - 7 in^{1/16}



127455
CUILLER CAFÉ
coffee/tea spoon
cuchara café
14 cm - 5 in^{1/2}



127479
CUILLER MOKA
demi tasse spoon
cuchara moka
11 cm - 4 in^{5/16}



127482
FOURCHETTE GÂTEAUX/COCKTAIL
pastry cocktail fork
tenedor pastel
13,8 cm - 5 in^{7/16}



130266
FOURCHETTE À HUITRES
oyster fork
tenedor ostras
13 cm - 5 in^{1/8}



PIÈCES DE SERVICE
SERVING PIECES
VERLAINE
P 116-117



205533
FOURCHETTE DE TABLE
table fork
tenedor mesa
20,7 cm - 8 in^{3/8}



205538
FOURCHETTE POISSON
fish fork
tenedor pescado
18,2 cm - 7 in^{3/16}



199160
COUTEAU TABLE MONOCOQUE/MANCHE ORFÈVRE LAME SCIE
table knife hollow handle serrated
cuchillo mesa enmangado hoja sierra
23,3 cm - 9 in^{3/16}



205537
COUTEAU POISSON
fish knife
cuchillo pescado
21,2 cm - 8 in^{3/8}



215601
COUTEAU TABLE MANCHE ORFÈVRE LAME SCIE RONDE
table knife hollow handle serrated rounded blade
cuchillo mesa enmangado redonda hoja sierra
23,3 cm - 9 in^{3/16}



199159
CUILLER CAFÉ
coffee/tea spoon
cuchara café
14,1 cm - 5 in^{3/16}



205534
CUILLER TABLE
table/pasta spoon
cuchara mesa
20,7 cm - 8 in^{1/8}



199161
CUILLER MOKA
demi tasse spoon
cuchara moka
11,2 cm - 4 in^{7/16}



205535
CUILLER À SOUPE ANGLAISE
bouillon spoon, round
cuchara consomé
17,7 cm - 6 in^{15/16}



199169
CUILLER SODA
iced tea spoon
cuchara soda/helado
18,8 cm - 7 in^{3/8}



205539
CUILLER DESSERT
dessert /soup spoon, oval
cuchara postre
18,2 cm - 7 in^{3/16}



199167
FOURCHETTE GÂTEAUX
cake fork
tenedor pastel
14,2 cm - 5 in^{9/16}



205538
FOURCHETTE DESSERT
dessert /salad fork
tenedor postre
18,2 cm - 7 in^{3/16}



199172
FOURCHETTE DE SERVICE
serving fork
tenedor de servicio/ensalada
25 cm - 9 in^{13/16}



199164
COUTEAU DESSERT MONOCOQUE/MANCHE ORFÈVRE LAME UNIE
dessert knife hollow handle
cuchillo postre enmangado hoja lisa
20,6 cm - 8 in^{1/8}



199171
CUILLER DE SERVICE
serving spoon
cuchara de servicio/ensalada
25 cm - 9 in^{13/16}



215602
COUTEAU DESSERT MANCHE ORFÈVRE LAME UNIE RONDE
dessert knife hollow handle rounded blade
cuchillo postre enmangado redonda hoja lisa
20,6 cm - 8 in^{1/8}



199173
PELLE À TARTE MONOBLOC
pastry server solid handle
pala para tarta
23,9 cm - 9 in^{7/16}



199170
COUTEAU À BEURRE MONOCOQUE/MANCHE ORFÈVRE LAME UNIE
butter knife hollow handle
cuchillo mantequilla enmangado hoja lisa
18,5 cm - 7 in^{5/16}



199174
LOUCHE
soup ladle
cazo
30,2 cm - 11 in^{7/8}



105831
FOURCHETTE DE TABLE
table fork
tenedor mesa
20,8 cm - 8 in^{3/16}



182460
COUTEAU TABLE MONOBLOC LOURD LAME SCIE
table knife heavy solid handle serrated
cuchillo mesa pesado hoja sierra
24,4 cm - 9 in^{5/8}



105886
COUTEAU TABLE MONOCOQUE/MANCHE ORFÈVRE LAME UNIE
table knife hollow handle
cuchillo mesa enmangado hoja lisa
24,6 cm - 9 in^{11/16}



105860
COUTEAU TABLE MONOCOQUE/MANCHE ORFÈVRE LAME SCIE
table knife hollow handle serrated
cuchillo mesa enmangado hoja sierra
24,6 cm - 9 in^{11/16}



105801
COUTEAU STEAK MONOCOQUE/MANCHE ORFÈVRE LAME SCIE
steak knife hollow handle serrated
cuchillo steak enmangado hoja sierra
23,9 cm - 9 in^{7/16}



105798
CUILLER TABLE
table/pasta spoon
cuchara mesa
20,8 cm - 8 in^{3/16}



112692
CUILLER À SOUPE ANGLAISE
bouillon spoon, round
cuchara consomé
17,2 cm - 6 in^{3/4}



105861
CUILLER DESSERT
dessert /soup spoon, oval
cuchara postre
18 cm - 7 in^{1/16}



105885
FOURCHETTE DESSERT
dessert /salad fork
tenedor postre
17,8 cm - 7 in



182463
COUTEAU DESSERT MONOBLOC LOURD LAME UNIE
dessert knife heavy solid handle
cuchillo postre pesado hoja lisa
21,1 cm - 8 in^{5/16}



105832
COUTEAU DESSERT MONOCOQUE/MANCHE ORFÈVRE LAME UNIE
dessert knife hollow handle
cuchillo postre penmangado hoja lisa
20,5 cm - 8 in^{1/16}



190420
COUTEAU À BEURRE MONOBLOC LOURD LAME UNIE
butter knife heavy solid handle
cuchillo mantequilla pesado hoja lisa
19 cm - 7 in^{1/2}



003332
COUTEAU À BEURRE MONOCOQUE/MANCHE ORFÈVRE LAME UNIE
butter knife hollow handle
cuchillo mantequilla enmangado hoja lisa
18,7 cm - 7 in^{3/8}



108918
FOURCHETTE POISSON
fish fork
tenedor pescado
17,8 cm - 7 in



108920
COUTEAU POISSON
fish knife
cuchillo pescado
19,7 cm - 7 in^{3/4}



105910
CUILLER À SAUCE GOURMET
gourmet/sauce spoon
cuchara para salsa
17,9 cm - 7 in^{1/16}



105833
CUILLER CAFÉ
coffee/tea spoon
cuchara café
14 cm - 5 in^{1/2}



105906
CUILLER MOKA
demi tasse spoon
cuchara moka
11 cm - 4 in^{5/16}



105800
CUILLER SODA
iced tea spoon
cuchara soda/helado
18,2 cm - 7 in^{3/16}



105795
FOURCHETTE GÂTEAUX/COCKTAIL
pastry/cocktail fork
tenedor pastel
13,8 cm - 5 in^{7/16}



123440
FOURCHETTE À HÙITRES
oyster fork
tenedor ostras
12,9 cm - 5 in^{1/16}



132782
FOURCHETTE À ESCARGOTS
snail fork
tenedor caracoles
13,5 cm - 5 in^{5/16}



130994
CUILLER TOAST
appetizer spoon
cuchara aperitivo
11,8 cm - 4 in^{5/8}



003390
COUTEAU FROMAGE MONOCOQUE/MANCHE ORFÈVRE LAME UNIE
cheese knife hollow handle
cuchillo queso enmangado
19,3 cm - 7 in^{5/8}



002185
FOURCHETTE DE SERVICE
serving fork
tenedor de servicio/ensalada
24,8 cm - 9 in^{3/4}



002186
CUILLER DE SERVICE
serving spoon
cuchara de servicio/ensalada
25 cm - 9 in^{13/16}



040646
SERVICE SALADE
salad serving set
set servicio/ensalada
25,8 cm - 10 in^{3/16}



083340
PELLE À TARTE MONOBLOC
pastry server solid handle
pala para tarta
24,9 cm - 9 in^{13/16}



097717
LOUCHE
soup ladle
cazo
29,8 cm - 11 in^{3/4}



002179
LOUCHE À SAUCE
sauce spoon
cazo para salsa
15,7 cm - 6 in^{3/16}



002191
PINCE À SUCRE
sugar tong
pinza para azúcar
11,5 cm - 4 in^{1/2}



105021
FOURCHETTE DE TABLE
table fork
tenedor mesa
20,9 cm - 8 in^{3/4}



190414
COUTEAU À BEURRE MONOBLOC LOURD LAME UNIE
butter knife heavy solid handle
cuchillo mantequilla pesado hoja lisa
19,7 cm - 7 in^{3/4}



190415
COUTEAU TABLE MONOBLOC LOURD LAME SCIE
table knife heavy solid handle serrated
cuchillo mesa pesado hoja sierra
24,8 cm - 9 in^{3/4}



016394
COUTEAU À BEURRE MONOCOQUE/MANCHE ORFÈVRE LAME UNIE
butter knife hollow handle
cuchillo mantequilla enmangado hoja lisa
18,9 cm - 7 in^{7/16}



105006
COUTEAU TABLE MONOCOQUE/MANCHE ORFÈVRE LAME SCIE
table knife hollow handle serrated
cuchillo mesa enmangado hoja sierra
24,7 cm - 9 in^{3/4}



104994
FOURCHETTE POISSON
fish fork
tenedor pescado
17,9 cm - 7 in^{1/16}



122746
COUTEAU STEAK MONOCOQUE/MANCHE ORFÈVRE LAME SCIE
steak knife hollow handle serrated
cuchillo steak enmangado hoja sierra
23,8 cm - 9 in^{3/8}



104995
COUTEAU POISSON
fish knife
cuchillo pescado
20 cm - 7 in^{7/8}



104988
CUILLER TABLE
table/pasta spoon
cuchara mesa
21,1 cm - 8 in^{5/16}



104977
CUILLER À SAUCE GOURMET
gourmet/sauce spoon
cuchara para salsa
18 cm - 7 in^{1/16}



104975
CUILLER À SOUPE ANGLAISE
bouillon spoon, round
cuchara consomé
17,4 cm - 6 in^{9/16}



104986
CUILLER CAFÉ
coffee/tea spoon
cuchara café
14,1 cm - 5 in^{9/16}



104985
CUILLER DESSERT
dessert /soup spoon, oval
cuchara postre
18 cm - 7 in^{1/16}



104993
CUILLER MOKA
demi tasse spoon
cuchara moka
11,2 cm - 4 in^{7/16}



105013
FOURCHETTE DESSERT
dessert /salad fork
tenedor postre
17,9 cm - 7 in^{1/16}



105012
FOURCHETTE GÂTEAUX/COCKTAIL
pastry/cocktail fork
tenedor pastel
13,9 cm - 5 in^{1/2}



190416
COUTEAU DESSERT MONOBLOC LOURD LAME UNIE
dessert knife heavy solid handle
cuchillo postre pesado hoja lisa
21,3 cm - 8 in^{3/8}



104989
COUTEAU DESSERT MONOCOQUE/MANCHE ORFÈVRE LAME UNIE
dessert knife hollow handle
cuchillo postre enmangado hoja lisa
20,6 cm - 8 in^{1/8}



104485
FOURCHETTE DE TABLE
table fork
tenedor mesa
20,8 cm - 8 in^{3/16}



182466
COUTEAU TABLE MONOBLOC LOURD LAME SCIE
table knife straight and heavy solid handle serrated
cuchillo mesa pesado recto mango hoja sierra
24,6 cm - 9 in^{11/16}



161390
COUTEAU TABLE MONOCOQUE/MANCHE ORFÈVRE LAME UNIE
table knife hollow handle
cuchillo mesa enmangado hoja lisa
24,6 cm - 9 in^{11/16}



161391
COUTEAU TABLE MONOCOQUE/MANCHE ORFÈVRE LAME SCIE
table knife hollow handle serrated
cuchillo mesa enmangado hoja sierra
24,6 cm - 9 in^{11/16}



122759
COUTEAU STEAK MONOCOQUE/MANCHE ORFÈVRE LAME SCIE
steak knife hollow handle serrated
cuchillo steak enmangado hoja sierra
23,9 cm - 9 in^{7/16}



104526
CUILLER TABLE
table/pasta spoon
cuchara mesa
20,8 cm - 8 in^{3/16}



112695
CUILLER À SOUPE ANGLAISE
bouillon spoon, round
cuchara consomé
17,2 cm - 6 in^{3/4}



104484
CUILLER DESSERT
dessert /soup spoon, oval
cuchara postre
18 cm - 7 in^{1/16}



104543
FOURCHETTE DESSERT
dessert /salad fork
tenedor postre
17,8 cm - 7 in



182467
COUTEAU DESSERT MONOBLOC LOURD LAME UNIE
dessert knife straight and heavy solid handle
cuchillo postre pesado recto mango hoja lisa
20,5 cm - 8 in^{1/16}



161394
COUTEAU DESSERT MONOCOQUE/MANCHE ORFÈVRE LAME UNIE
dessert knife hollow handle
cuchillo postre enmangado hoja lisa
20,5 cm - 8 in^{1/16}



190419
COUTEAU À BEURRE MONOBLOC LOURD LAME UNIE
butter knife straight and heavy solid handle
cuchillo mantequilla pesado recto mango hoja lisa
18,7 cm - 7 in^{1/2}



122760
COUTEAU À BEURRE MONOCOQUE/MANCHE ORFÈVRE LAME UNIE
butter knife hollow handle
cuchillo mantequilla enmangado hoja lisa
18,7 cm - 7 in^{3/4}



108922
FOURCHETTE POISSON
fish fork
tenedor pescado
17,8 cm - 7 in



108924
COUTEAU POISSON
fish knife
cuchillo pescado
19,7 cm - 7 in^{3/4}



145451
CUILLER À SAUCE GOURMET
gourmet/sauce spoon
cuchara para salsa
17,9 cm - 7 in^{1/16}



104561
CUILLER CAFÉ
coffee/tea spoon
cuchara café
14 cm - 5 in^{1/2}



161398
CUILLER MOKA
demi tasse spoon
cuchara moka
11 cm - 4 in^{5/16}



124259
CUILLER SODA
iced tea spoon
cuchara soda/helado
18,2 cm - 7 in^{3/16}



104480
FOURCHETTE GÂTEAUX/COCKTAIL
pastry/cocktail fork
tenedor pastel
13,8 cm - 5 in^{7/16}



123434
FOURCHETTE À HÛÎTRES
oyster fork
tenedor ostras
12,9 cm - 5 in^{1/16}



189208
COUTEAU FROMAGE MONOCOQUE/MANCHE ORFÈVRE LAME UNIE
cheese knife hollow handle
cuchillo queso enmangado
19,3 cm - 7 in^{5/8}



195757
FOURCHETTE DE SERVICE
serving fork
tenedor de servicio/ensalada
24,8 cm - 9 in^{3/4}



195755
CUILLER DE SERVICE
serving spoon
cuchara de servicio/ensalada
25 cm - 9 in^{13/16}



195757
FOURCHETTE À DÉCOUPER
carving fork
tenedor trinchante
24,8 cm - 9 in^{3/4}



189511
COUTEAU À DÉCOUPER MONOCOQUE/MANCHE ORFÈVRE LAME UNIE
carving knife hollow handle
cuchillo trinchante enmangado hoja lisa
28,7 cm - 11 in^{5/16}



195750
SERVICE SALADE
salad serving set
set servicio/ensalada
25,7 cm - 10 in^{1/8}



195753
PELLE À TARTE MONOBLOC
pastry server solid handle
pala para tarta
24,9 cm - 9 in^{13/16}



195762
LOUCHE
soup ladle
cazo
29,8 cm - 11 in^{3/4}



195759
LOUCHE À SAUCE
sauce spoon
cazo para salsa
15,7 cm - 6 in^{3/16}



141094
FOURCHETTE DE TABLE
table fork
tenedor mesa
23,3 cm - 8 in



103564
CUILLER CAFÉ
coffee/tea spoon
cuchara café
13,5 cm - 5 in^{5/16}



103857
COUTEAU TABLE MONOBLOC LAME SCIE
table knife straight and heavy solid handle serrated
cuchillo mesa pesado recto mango hoja sierra
23,7 cm - 9 in^{5/16}



109471
CUILLER MOKA
demi tasse spoon
cuchara moka
11 cm - 4 in^{5/16}



160433
COUTEAU STEAK MONOBLOC LAME SCIE
steak knife solid handle serrated
cuchillo steak hoja sierra
23,6 cm - 9 in^{5/16}



105800
CUILLER SODA
iced tea spoon
cuchara soda/helado
18,2 cm - 7 in^{3/16}



141092
CUILLER TABLE
table/pasta spoon
cuchara mesa
20,4 cm - 8 in^{1/16}



109472
FOURCHETTE GÂTEAUX/COCKTAIL
pastry/cocktail fork
tenedor pastel
15 cm - 5 in^{7/16}



112692
CUILLER À SOUPE ANGLAISE
bouillon spoon, round
cuchara consomé
17,2 cm - 6 in^{3/4}



123440
FOURCHETTE À HÙITRES
oyster fork
tenedor ostras
12,9 cm - 5 in^{1/16}



108232
CUILLER DESSERT
dessert /soup spoon, oval
cuchara postre
17,9 cm - 7 in^{1/16}



132782
FOURCHETTE À ESCARGOTS
oyster fork
tenedor ostras
13,5 cm - 5 in^{5/16}



108234
FOURCHETTE DESSERT
dessert /salad fork
tenedor postre
17,8 cm - 7 in



002185
FOURCHETTE DE SERVICE
serving fork
tenedor de servicio/ensalada
24,8 cm - 9 in^{3/4}



210628
COUTEAU DESSERT MONOBLOC LAME SCIE
dessert knife solid handle serrated
cuchillo postre hoja sierra
20,6 cm - 8 in^{1/8}



002186
CUILLER DE SERVICE
serving spoon
cuchara de servicio/ensalada
25 cm - 9 in^{13/16}



108918
FOURCHETTE POISSON
fish fork
tenedor pescado
17,8 cm - 7 in



040646
SERVICE SALADE
salad serving set
set servicio/ensalada
25,8 cm - 10 in^{3/16}



108920
COUTEAU POISSON
fish knife
cuchillo pescado
19,7 cm - 7 in^{3/4}



083340
PELLE À TARTE MONOBLOC
pastry server solid handle
pala para tarta
24,9 cm - 9 in^{13/16}



097717
LOUCHE
soup ladle
cazo
29,8 cm - 11 in^{3/4}



002179
LOUCHE À SAUCE
sauce spoon
cazo para salsa
15,7 cm - 6 in^{3/16}



141089
FOURCHETTE DE TABLE
table fork
tenedor mesa
20,3 cm - 8 in



103550
CUILLER CAFÉ
coffee/tea spoon
cuchara café
13,5 cm - 5 in^{5/16}



113017
COUTEAU TABLE MONOBLOC LOURD LAME SCIE
table knife heavy solid handle serrated
cuchillo mesa pesado hoja sierra
24,4 cm - 9 in^{5/8}



109465
CUILLER MOKA
demi tasse spoon
cuchara moka
11 cm - 4 in^{5/16}



160427
COUTEAU STEAK MONOBLOC LAME SCIE
steak knife solid handle serrated
cuchillo steak hoja sierra
23,2 cm - 9 in^{1/8}



124259
CUILLER SODA
iced tea spoon
cuchara soda/helado
18,2 cm - 7 in^{3/16}



141086
CUILLER TABLE
table/pasta spoon
cuchara mesa
20,4 cm - 8 in^{1/16}



109466
FOURCHETTE GÂTEAUX/COCKTAIL
pastry/cocktail fork
tenedor pastel
15 cm - 5 in^{7/8}



112695
CUILLER À SOUPE ANGLAISE
bouillon spoon, round
cuchara consomé
17,2 cm - 6 in^{3/4}



123434
FOURCHETTE À HUITRES
oyster fork
tenedor ostras
12,9 cm - 5 in^{1/16}



108236
CUILLER DESSERT
dessert /soup spoon, oval
cuchara postre
17,9 cm - 7 in^{1/16}



195757
FOURCHETTE DE SERVICE
serving fork
tenedor de servicio/ensalada
24,8 cm - 9 in^{3/4}



108238
FOURCHETTE DESSERT
dessert /salad fork
tenedor postre
17,8 cm - 7 in



195755
CUILLER DE SERVICE
serving spoon
cuchara de servicio/ensalada
25 cm - 9 in^{13/16}



113019
COUTEAU DESSERT MONOBLOC LOURD LAME UNIE
dessert knife heavy solid handle
cuchillo postre pesado hoja lisa
21 cm - 8 in^{1/4}



195750
SERVICE SALADE
salad serving set
set servicio/ensalada
25,7 cm - 10 in^{1/8}



189971
COUTEAU À BEURRE MONOBLOC LAME UNIE
butter knife
cuchillo mantequilla hoja lisa
18,9 cm - 7 in^{7/16}



195753
PELLE À TARTE MONOBLOC
pastry server solid handle
pala para tarta
24,9 cm - 9 in^{13/16}



108922
FOURCHETTE POISSON
fish fork
tenedor pescado
17,8 cm - 7 in



195762
LOUCHE
soup ladle
cazo
29,8 cm - 11 in^{3/4}



108924
COUTEAU POISSON
fish knife
cuchillo pescado
19,7 cm - 7 in^{3/4}



195759
LOUCHE À SAUCE
sauce spoon
cazo para salsa
15,7 cm - 6 in^{3/16}



230285
FOURCHETTE DE TABLE
table fork
tenedor mesa
20,3 cm - 8 in



230287
COUTEAU TABLE MONOBLOC LOURD LAME SCIE
table knife heavy solid handle serrated
cuchillo mesa pesado hoja sierra
24,4 cm - 9 in^{5/8}



230293
COUTEAU STEAK MONOBLOC LAME SCIE
steak knife solid handle serrated
cuchillo steak hoja sierra
23,2 cm - 9 in^{1/8}



230286
CUILLER TABLE
table/pasta spoon
cuchara mesa
20,4 cm - 8 in^{1/16}



230291
CUILLER DESSERT
dessert /soup spoon, oval
cuchara postre
17,9 cm - 7 in^{1/16}



230290
FOURCHETTE DESSERT
dessert /salad fork
tenedor postre
17,8 cm - 7 in



230292
COUTEAU DESSERT MONOBLOC LOURD LAME UNIE
dessert knife heavy solid handle
cuchillo postre pesado hoja lisa
21 cm - 8 in^{1/4}



230288
CUILLER CAFÉ
coffee/tea spoon
cuchara café
13,5 cm - 5 in^{5/16}



230289
CUILLER MOKA
demi tasse spoon
cuchara moka
11 cm - 4 in^{5/16}



232308
COUTEAU À BEURRE
butter knife
cuchillo mantequilla hoja lisa
18,9 cm - 7 in^{7/16}



NEW MIKADO VINTAGE
VINTAGE LINE



105804
FOURCHETTE DE TABLE
table fork
tenedor mesa
21 cm - 8 in^{1/4}



105837
FOURCHETTE POISSON
fish fork
tenedor pescado
18 cm - 7 in^{1/16}



105892
COUTEAU TABLE MONOBLOC LAME SCIE
table knife solid handle serrated
cuchillo mesa hoja sierra
25 cm - 9 in^{13/16}



105912
COUTEAU POISSON
fish knife
cuchillo pescado
20 cm - 7 in^{7/8}



105864
COUTEAU TABLE MONOCOQUE/MANCHE ORFÈVRE LAME UNIE
table knife hollow handle
cuchillo mesa enmangado hoja lisa
24,7 cm - 9 in^{3/4}



105838
CUILLER CAFÉ
coffee/tea spoon
cuchara café
14,1 cm - 5 in^{9/16}



105913
COUTEAU TABLE MONOCOQUE/MANCHE ORFÈVRE LAME SCIE
table knife hollow handle serrated
cuchillo mesa enmangado hoja sierra
24,7 cm - 9 in^{3/4}



105891
CUILLER MOKA
demi tasse spoon
cuchara moka
11 cm - 4 in^{5/16}



160424
COUTEAU STEAK MONOBLOC LAME SCIE
steak knife solid handle serrated
cuchillo steak hoja sierra
23,2 cm - 9 in^{1/8}



105805
FOURCHETTE GÂTEAUX/COCKTAIL
pastry/cocktail fork
tenedor pastel
13,9 cm - 5 in^{1/2}



105911
CUILLER TABLE
table/pasta spoon
cuchara mesa
21 cm - 8 in^{1/4}



105803
FOURCHETTE À HUÎTRES
oyster fork
tenedor ostras
13,2 cm - 5 in^{3/16}



105863
CUILLER DESSERT
dessert /soup spoon, oval
cuchara postre
18 cm - 7 in^{1/16}



000490
FOURCHETTE DE SERVICE
serving fork
tenedor de servicio/ensalada
24,6 cm - 9 in^{11/16}



105890
FOURCHETTE DESSERT
dessert /salad fork
tenedor postre
18 cm - 7 in^{1/16}



000491
CUILLER DE SERVICE
serving spoon
cuchara de servicio/ensalada
24,9 cm - 9 in^{13/16}



210626
COUTEAU DESSERT MONOBLOC LAME SCIE
dessert knife solid handle serrated
cuchillo postre hoja sierra
20,7 cm - 8 in^{1/8}



105802
COUTEAU DESSERT MONOCOQUE/MANCHE ORFÈVRE LAME UNIE
table knife hollow handle
cuchillo postre enmangado hoja lisa
20,5 cm - 8 in^{1/16}



LA PLATERIE - HOLLOWWARE - ORFÈBRERÍA

A travers des objets en acier dédiés à la table, au service et à la dégustation, DEGRENNE exprime la richesse de son métier d'orfèvre. Des pièces de forme aux lignes raffinées jusqu'aux accessoires présentés sur la table des convives, la collection platerie DEGRENNE s'accorde parfaitement avec l'ensemble des gammes pour offrir un service élégant et moderne.

DEGRENNE expresses its highly-varied metal-working expertise through steel products designed for the table, service and tasting and appreciating. From shaped pieces with sophisticated lines to accessories showcased on the guests' table, DEGRENNE's hollowware collection fits perfectly with all the other ranges, making for an elegant and contemporary service.

A través de los objetos de acero dedicados a la mesa, al servicio y a la degustación, DEGRENNE expresa la riqueza de su oficio de orfebre. Desde piezas de forma con líneas refinadas hasta accesorios presentados en la mesa de los invitados, la colección de platería DEGRENNE combina perfectamente con el conjunto de las gamas para ofrecer un servicio elegante y moderno.



©Patrick Rougeureau



185018 186458
PLATEAU RECTANGULAIRE AVEC ANSES
rectangular serving tray with handles
bandeja rectangular con asas
77 X 55 cm - 30 in^{5/16} x 21 in^{5/8}
68,5 x 46,5 cm - 25 in^{15/16} x 18 in^{5/16}

185023 186459
PLATEAU RECTANGULAIRE AVEC ANSES GASTRONORM 2/1
rectangular serving tray with handles
bandeja rectangular con asas
65 X 53 cm - 25 in^{9/16} x 20 in^{7/8}
56,5 x 45,5 cm - 22 in^{1/4} x 17 in^{15/16}

185022 186460
PLATEAU RECTANGULAIRE AVEC ANSES
rectangular serving tray with handles
bandeja rectangular con asas
60 X 40 cm - 23 in^{5/8} x 15 in^{3/4}
51,5 x 31,5 cm - 20 in^{1/8} x 12 in^{3/8}



185021 186461
PLATEAU RECTANGULAIRE
SANS ANSE GASTRONORM 1/1
rectangular serving tray
without handle
bandeja rectangular sin asa
53 x 32,5 cm - 20 in^{7/8} x 12 in^{13/16}
46,07 x 25,57 cm - 18 in^{1/8} x 10 in^{1/16}



185020 186462
PLATEAU RECTANGULAIRE
SANS ANSE
rectangular serving tray
without handle
bandeja rectangular sin asa
40 x 27 cm - 15 in^{3/4} x 10 in^{5/8}
33,47 x 20,47 cm - 13 in^{3/8} x 8 in^{1/16}



185019 186463
PLATEAU RECTANGULAIRE
SANS ANSE GASTRONORM 1/2
rectangular serving tray
without handle
bandeja rectangular sin asa
32,5 x 26,5 cm - 12 in^{13/16} x 10 in^{7/16}
35,97 x 19,97 cm - 10 in^{1/4} x 7 in^{7/8}



227767 227768
PLATEAU RECTANGULAIRE
SANS ANSE
rectangular serving tray
without handle
bandeja rectangular sin asa
22 x 14 cm - 8 in^{1/16} x 5 in^{1/2}
19,3 x 10,5 cm - 7 in^{5/8} x 4 in^{1/8}



185024 186457
PLATEAU ROND
round tray
bandeja redonda
42 cm - 16 in^{5/16}





211886 **213857**
PLATEAU RECTANGULAIRE AVEC ANSES GASTRONORM 2/1
rectangular serving tray with handles
 bandeja rectangular con asas
 65 X 53 cm - 25 in^{9/16} x 20 in^{7/8}
 56,5 x 45,5 cm - 22 in^{1/4} x 17 in^{15/16}

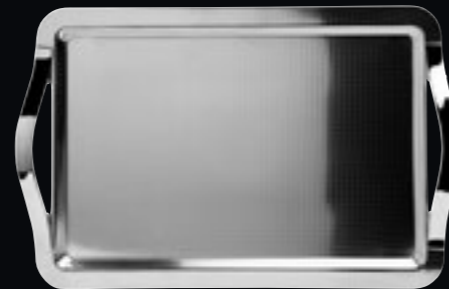

211887 **213858**
PLATEAU RECTANGULAIRE AVEC ANSES
rectangular serving tray with handles
 bandeja rectangular con asas
 60 X 40 cm - 23 in^{5/8} x 15 in^{3/4}
 51,5 x 31,5 cm - 20 in^{1/8} x 12 in^{3/8}



211888 **213859**
PLATEAU RECTANGULAIRE SANS ANSE GASTRONORM 1/2
rectangular serving tray without handle
 bandeja rectangular sin asa
 26,5 x 32,5 cm - 10 in^{7/16} x 12 in^{13/16}
 19,97 x 35,97 cm - 7 in^{7/8} x 10 in^{1/4}

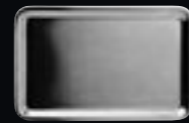

211889 **213860**
PLATEAU RECTANGULAIRE SANS ANSE
rectangular serving tray without handle
 bandeja rectangular sin asa
 22 x 14 cm - 8 in^{1/16} x 5 in^{1/2}
 19,3 x 10,5 cm - 7 in^{5/8} x 4 in^{1/8}



NEW



230872 **230874**
DESSOUS DE BOUTEILLE
bottle coaster
 posabotella
 13,5 cm - 5 in^{5/16}





183019 186451
PLAT OVALE
oval dish
fuente ovalada
46 x 31 cm - 18 in^{1/8} x 12 in^{3/16}



183018 186450
PLAT OVALE
oval dish
fuente ovalada
41 x 28 cm - 16 in^{1/8} x 11 in



183017 186449
PLAT OVALE
oval dish
fuente ovalada
38 x 25 cm - 14 in^{15/16} x 9 in^{13/16}



183021 186453
PLAT À POISSON
fish dish
fuente para pescado
60 x 27 cm - 23 in^{5/8} x 10 in^{5/8}



220120 220121
PLAT ROND CREUX
round deep dish
bandeja redonda
33,5 cm - 13 in^{3/16}



186198 186456
SAUCIÈRE
sauce boat
salsera
20 cl - 19 x 7,6 cm - 6 oz^{3/4} - 7 in^{1/2} x 3 in



185307 186455
BEURRIER
butter dish
mantequillera indiv.
Ø 7,6 x 7 cm - Ø 3 in x 2 in^{3/4}



190255
SOCLE BEURRIER PORCELAINE
butter dish base porcelain
mantequillera sin tapa
Ø 5 x 3,2 cm - Ø 1 in^{5/16} x 1 in^{1/4}



208862
Ø 5 x H 6 cm
Ø 1 in^{15/16} x h 2 in^{3/8}



211397
Ø 6,4 x H 6 cm
Ø 2 in^{1/2} x h 2 in^{3/8}

PORTE SUCRE / CENTRE DE TABLE
sugar holder/table centerpiece
centro de mesa



VERSEUSE - COFFEE / TEA POT - CAFETERA / TETERA



213850 219563

VERSEUSE
coffee / tea pot
cafetera / tetera
1,5 l - 50 oz^{3/4}

213851 219564

VERSEUSE
coffee / tea pot
cafetera / tetera
70 cl - 23 oz^{11/16}

213852 219565

VERSEUSE
coffee / tea pot
cafetera / tetera
35 cl - 11 oz^{13/16}

213849 219561

PICHET
jug
jarra
2 l - 67 oz^{5/8}

POT ISOTHERME - INSULATED POT - JARRA ISOTÉRMICA



213846 219557

POT ISOTHERME
insulated pot
jarra isotérmica
1,2 l - 40 oz^{9/16}

213847 219558

POT ISOTHERME
insulated pot
jarra isotérmica
70 cl - 23 oz^{11/16}

213848 219559

POT ISOTHERME
insulated pot
jarra isotérmica
30 cl - 10 oz^{1/8}



BEC VERSEUR ANTI GOUTTES
an anti-spill
una baquilla antigoteo

CRÉMIER - CREAM JUG - LECHERA



213853 219566

CRÉMIER
cream jug
lechera
35 cl - 11 oz^{13/16}

213854 219567

CRÉMIER
cream jug
lechera
15 cl - 5 oz^{1/16}

182341 184612

SUCRIER
sugar bowl
azucarero con tapa
35 cl - 11 oz^{13/16}

002191 129797

PINCE À SUCRE
sugar tong
pinza para azúcar
11,5 cm - Ø 4 in^{1/2}

NEWPORT P60-61



NEWPORT
FINEDINING



184180 188895
SEAU À CHAMPAGNE 2 BOUTEILLES
champagne bucket 2 bottles
champanera 2 botellas
Ø 24 x 25,5 cm - Ø 9in^{7/16} x 10in^{1/16}



186030 188894
SEAU À CHAMPAGNE 1 BOUTEILLE
champagne bucket 1 bottle
champanera 1 botella
Ø 20 x 22,5 cm - Ø 7in^{7/8} x 8 in^{7/8}



184181 188896
SEAU À GLACE AVEC COUVERCLE
ice bucket with lid
cubitera con tapa
Ø 15 x 16 cm - 5 in^{7/8} x 6 in^{5/16}



185607 188893
PORTE SEAU À CHAMPAGNE
1 OU 2 BOUTEILLES
champagne bucket stand
(1 or 2 bottles)
portacubo 1/2 botellas
63,5 cm - 25 in

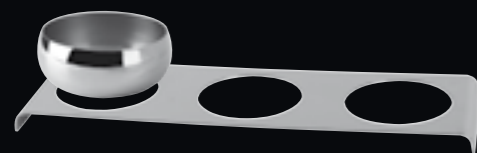

214185
COUPE ACIER
stainless steel bowl
tazón acero
Ø 11,5 cm - Ø 4 in^{1/2}

214182
PRÉSENTOIR ACIER 3 TROUS
three holes stainless steel stand mirror finish
expositor de acero en brillo 3 agujeros
41 x 12,5 x 2,3 cm - Ø 16 in^{1/8} x 4 in^{15/16} x 7/8



004014
PINCE À GLACE
ice tong
pinza para hielo
16 cm - Ø 6 in^{5/16}



185879
COUPELLE EMPILABLE
stackable bowl
apilamiento bol
Ø 9 x 5 cm
Ø 3in^{9/16} x 1in^{15/16}



185880
COUPELLE EMPILABLE
stackable bowl
apilamiento bol
Ø 9 x 3 cm
Ø 3in^{9/16} x 1in^{3/16}



216919
VERRINE SEL AIMANTÉE
salt cellar w/magnet
salero con imán
4,1 x 6,7 cm - 1in^{5/8} x 2in^{5/8}



216920
VERRINE POIVRE AIMANTÉE
pepper cellar w/magnet
pimentero con imán
4,1 x 6,7 cm - 1in^{5/8} x 2in^{5/8}



216922
ENSEMBLE SEL & POIVRE AIMANTÉ
salt & pepper cellar w/magnet
conjunto salero/pimentero con imán
8,5 x 10,6 cm - 3in^{3/8} x 4in^{3/16}

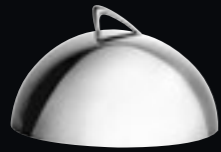

182614 - 184477
CLOCHE ASSIETTE
dome cover, stainless steel
campana
Ø 24 cm - Ø 9 in^{7/16}

182301 - 184476
CLOCHE ASSIETTE
dome cover, stainless steel
campana
Ø 14,8 cm - Ø 5 in^{13/16}

044113 - 101512
CLOCHE ASSIETTE
dome cover, stainless steel
campana
Ø 26 cm - Ø 10 in^{1/4}

044112 - 101510
CLOCHE ASSIETTE
dome cover, stainless steel
campana
Ø 22 cm - Ø 8 in^{11/16}



204043
CLOCHE VERRE BOROSILICATE
glass dome cover
campana vidrio borosilicato
17x9 cm - 6 in^{11/16} x 3 in^{9/16}

206504
**BOUCHON PORCELAINE
POUR CLOCHE VERRE**
porcelain lid for glass dome cover
tapa de porcelana para
campana de vidrio
5,2 cm - 2 in^{1/16}

159597 - 101453
BOL RINCE DOIGTS
finger bowl
lavaderos
Ø 11 x 4 cm - Ø 4 in^{5/16} x 1 in^{9/16}

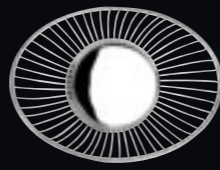
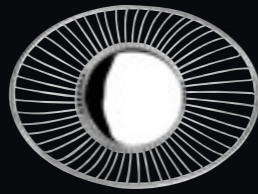

120522 - 131115
CORBEILLE À PAIN RONDE EN FIL
round bread basket
panera redonda
Ø 20,5 x 7,5 cm
Ø 8 in^{1/16} x 2 in^{15/16}

128910 - 131114
CORBEILLE À PAIN RONDE EN FIL
round bread basket
panera redonda
Ø 17,5 x 6 cm
Ø 6 in^{7/8} x 2 in^{3/8}

128912 - 131117
CORBEILLE À PAIN OVALE EN FIL
oval bread basket
panera ovalada
Ø 24 x 17 cm - h 7,5 cm
Ø 9 in^{7/16} x 6 in^{11/16} - h 2 in^{15/16}

128911 - 131118
CORBEILLE À PAIN OVALE EN FIL
oval bread basket
panera ovalada
Ø 20 x 15 cm - h 6 cm
Ø 7 in^{7/8} x 5 in^{7/8} - h 2 in^{3/8}



LE VERRE - GLASSWARE - CRISTALERÍA

Les collections de verres DEGRENNE invitent au partage et à la dégustation. Leurs qualités esthétiques ainsi que leur résistance exceptionnelle, garantit une utilisation en toute occasion. Pour choisir en toute simplicité le verre qui révélera tous les arômes du vin, découvrez Origine : cette collection composées de 5 verres à pied et d'un gobelet permet d'associer de manière évidente un vin avec le bon verre.

Pour compléter harmonieusement la table, les verres de couleur DEGRENNE, teints dans la masse, offrent une esthétique et une qualité à l'épreuve du temps et des lavages au lave-vaisselle. Soufflée bouche de manière artisanale, chaque pièce est unique !

DEGRENNE'S glassware collections are an invitation to socialize and enjoy a drink. Our glassware's looks and exceptional sturdiness mean that it can be used at any occasion. Opt for Origine if you are looking for a glass to reveal all the flavour nuances of wine: this collection of five stemmed glasses and a tumbler makes it easy to combine wine with the right glass.

DEGRENNE'S integrally dyed glasses are a harmonious addition to the dining table and offer looks and quality that withstand the test of time and repeated washing in the dishwasher. Each hand-blown glass is unique !

Las colecciones de copas DEGRENNE invitan a compartir y a degustar. Sus cualidades estéticas así como su resistencia, excepcional, garantizan un uso en cualquier ocasión. Para elegir con total sencillez la copa que revele todos los aromas del vino, descubra Origine: esta colección compuesta por 5 copas de vino y un vaso permite asociar de manera evidente un vino con la copa adecuada.

Para completar la mesa con armonía, las copas de color DEGRENNE, pintadas en masa, ofrecen una estética y una calidad que supera el paso del tiempo y los lavados en el lavavajillas. Soplada en boca de manera artesanal, ¡cada pieza es única !





184584
FLÛTE À CHAMPAGNE
Champagne flute
flauta Champán
27 cl - Ø 8 x h 24,3 cm
9 oz ¹/₈ - Ø 3 in¹/₈ x h 9 in⁹/₁₆

184583
VERRE À VIN BLANC
white wine glass
copa de vino blanco
35 cl - Ø 8 x h 22,3 cm
11oz ¹³/₁₆ - Ø 3 in¹/₈ x h 8 in³/₄

184582
VERRE À VIN ROUGE
red wine glass
copa de vino tinto
42 cl - Ø 8,3 x h 23,1 cm
14 oz ³/₁₆ - Ø 3 in¹/₄ x h 9 in¹/₈

184581
VERRE À EAU
water glass
copa de agua
48 cl - Ø 8,9 x h 23,5 cm
16 oz ¹/₄ - Ø 3 in¹/₂ x h 9 in¹/₄



184582





184551
FLÛTE À CHAMPAGNE
Champagne flute
flauta Champán
19 cl
Ø 6,3 x h 22,4 cm
6 oz^{7/16}
Ø 2 in^{1/2} x h 8 in^{13/16}



184549
VERRE À VIN BLANC
white wine glass
copa de vino blanco
28 cl
Ø 7,4 x h 20,8 cm
9 oz^{7/16}
Ø 2 in^{15/16} x h 8 in^{3/16}



184548
VERRE À VIN ROUGE
red wine glass
copa de vino tinto
35 cl
Ø 8 x h 21,4 cm
11 oz^{13/16}
Ø 3 in^{1/8} x h 8 in^{7/16}



184547
VERRE À EAU
water glass
copa de agua
45 cl
Ø 8,4 x h 22,5 cm
15 oz^{3/16}
Ø 3 in^{5/16} x h 8 in^{1/16}



184550
VERRE À BORDEAUX
Bordeaux glass
copa de Cava
64,5 cl
Ø 9,5 x h 23,8 cm
21 oz^{13/16}
Ø 3 in^{3/4} x h 9 in^{3/8}



210812
VERRE À BOURGOGNE
Burgundy glass
copa Bourgogne
70 cl
Ø 10,5 x h 23,1 cm
23 oz^{11/16}
Ø 4 in^{1/8} x h 9 in^{1/8}



184555
GOBELET HAUT
high tumbler
vaso alto
36 cl
Ø 6,8 x h 14,2 cm
12 oz^{3/16}
Ø 2 in^{11/16} x h 5 in^{9/16}



184554
GOBELET BAS
low tumbler
vaso bajo
33 cl
Ø 8 x h 10,2 cm
11 oz^{3/16}
Ø 3 in^{1/8} x h 4 in



184553
GOBELET BAS
low tumbler
vaso bajo
23 cl
Ø 7,6 x h 9,2 cm
7 oz^{3/4}
Ø 3 in x h 3 in^{5/8}



184552
GOBELET BAS/VERRINE
low tumbler/appetizer glass
vaso bajo/vasitos
15 cl
Ø 6,4 x h 8 cm
5 oz^{1/16}
Ø 2 in^{1/2} x h 3 in^{1/8}



184548





184556
FLÛTE À CHAMPAGNE
Champagne flute
flauta Champán
20 cl - Ø 6,7 x h 21,2 cm
6 oz^{3/4} - Ø 2 in^{5/8} x h 8 in^{3/8}



190537
VERRE À VIN
wine glass
copa de vino
35 cl - Ø 7,8 x h 19,6 cm
11oz^{13/16} - Ø 3 in^{1/16} x h 7 in^{11/16}



190536
VERRE À EAU
water glass
copa de agua
45 cl - Ø 8,4 x h 20,5 cm
15 oz^{3/16} - Ø 3 in^{5/16} x h 8 in^{1/16}



190538
GOBELET
tumbler
vaso
47 cl - Ø 8,5 x h 12,1 cm
15 oz^{7/8} - Ø 3 in^{3/8} x h 4 in^{3/4}

DÉCOR TAILLÉ DANS LE VERRE
CUT-GLASS DESIGN
DECORACIÓN TALLADA EN CRISTAL



190537





DEGRENNÉ s'est associé à Manuel Peyrondet, Meilleur Ouvrier de France Sommelier 2013 pour créer Origine, la première gamme de 5 verres à pied complétée d'un gobelet, permettant d'associer de manière simple et évidente un vin avec le bon verre.

DEGRENNÉ has joined forces with Manuel Peyrondet, the 2013 winner of the prestigious meilleur ouvrier de France sommelier award, to create Origine, the first range of five stemmed glasses plus a tumbler, making it easy to choose the right glass for your wine.

DEGRENNÉ se ha asociado con Manuel Peyrondet, el mejor obrador de Francia sumiller de 2013 para crear Origine, la primera gama de 5 copas de vino completada con un vaso, que permite asociar de manera sencilla y evidente un vino con la copa adecuada.

À CHAQUE VERRE SON VIN A GLASS FOR EACH AND EVERY WINE



N°1	N°2	N°3	N°4	N°5	N°6
EFFERVESCENCE SPARKLING EFFERVESCENCIA	FRAÎCHEUR FRESHNESS FRESCURA	PUISSANCE STRENGTH POTENCIA	SUBTILITÉ SUBTLETY SUTILEZA	DOUCEUR SWEETNESS DULZOR	MINÉRALITÉ MINERALITY MINEARL
Champagne, Prosecco	Riesling, Sauvignon, Chenin, Gamay, Cabernet, Franc	Grenache, Merlot, Malbec, Syrah, Cabernet Sauvignon	Pinot noir, Chardonnay, Bourgogne	Pour les vins moelleux et liquoreux For sweet & syrupy wines Para los vinos melosos y licorosos	Pour toutes les eaux Still & sparkling water Para todas las aguas



3 LEVIERS ONT ÉTÉ IDENTIFIÉS 3 KEY FACTORS WERE IDENTIFIED SE HAN IDENTIFICADO 3 PARÁMETROS

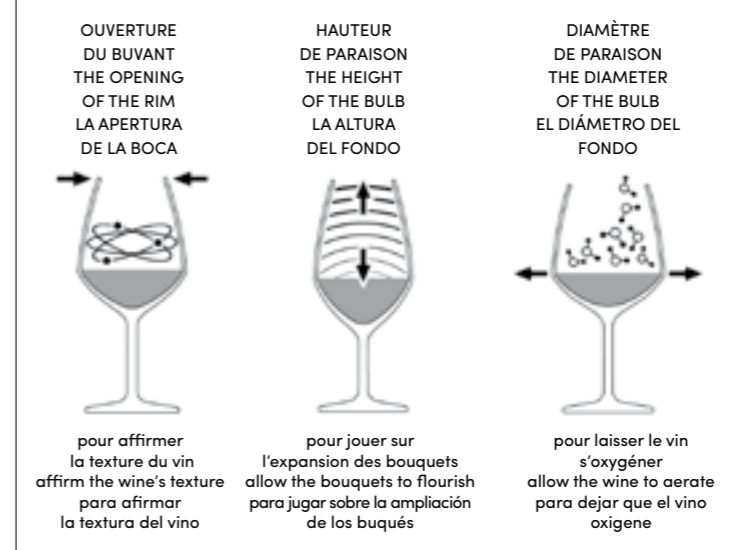



216733
N°1
EFFERVESCENCE
effervescence
espuma
22,5 cl
Ø 7,1 x h 21 cm
7oz^{5/8}
Ø 2 in^{13/16} x h 8 in^{1/4}



216730
N°2
FRAÎCHEUR
freshness
frescura
50 cl
Ø 8,9 x h 21,5 cm
16 oz^{15/16}
Ø 3 in^{1/2} x h 8 in^{7/16}



216731
N°3
PUISSANCE
strength
potencia
50 cl
Ø 9,5 x h 21,5 cm
16 oz^{15/16}
Ø 3 in^{3/4} x h 8 in^{7/16}



216732
N°4
SUBTILITÉ
(BOURGOGNE, PINOT NOIR, CHARDONNAY)
subtlety (Burgundy, Chardonnay and Pinot noir)
sutileza (Borgoña, Chardonnay y Pinot noir)
60 cl
Ø 10,2 x h 21,5 cm
20 oz^{5/16}
Ø 4 in x h 8 in^{7/16}



216734
N°5
DOUCEUR
(VINS MOÛLLEUX ET LIQOREUX)
sweetness (sweet and syrupy wines)
dulzor (melosos y digestivos)
20 cl
Ø 6,9 x h 20 cm
6 oz^{3/4}
Ø 2 in^{11/16} x h 7 in^{7/8}



225050
N°6
MINÉRALITÉ
(POUR TOUTES LES EAUX)
minerality (still and sparkling water)
mineral (acqua)
53 cl - Ø 9,6 x h 11,8 cm
17oz^{15/16} - Ø 3 in^{3/4} x h 4 in^{5/8}



216730

- HAUTEUR COMPATIBLE LAVE-VAISSELLE
DISHWASHER COMPATIBLE HEIGHT
ALTURA COMPATIBLE CON LAVAVAJILLAS
- SERVICE FACILITÉ PAR LA JAUGE NATURELLE DE 12 CL
SERVICE IS FACILITATED BY THE 12 CL MARKING
SERVICIO FACILITADO POR EL INDICADOR
DE NIVEL NATURAL DE 12 CL





184566
FLÛTE À CHAMPAGNE
Champagne flute
flauta Champán
19 cl
Ø 5,3 x h 21,9 cm
6 oz^{7/16}
Ø 2 in^{1/16} x h 8 in^{5/8}



184563
VERRE À VIN BLANC
white wine glass
copa de vino blanco
28 cl
Ø 7,3 x h 21,2 cm
9 oz^{7/16}
Ø 2 in^{7/8} x h 8 in^{3/8}



184562
VERRE À VIN ROUGE
red wine glass
copa de vino tinto
37 cl
Ø 7,7 x h 21,4 cm
12 oz^{1/2}
Ø 3 in^{1/16} x h 8 in^{7/16}



184561
VERRE À EAU
water glass
copa de agua
49,5 cl
Ø 8,6 x h 22,7 cm
16 oz^{3/4}
Ø 3 in^{3/8} x h 8 in^{15/16}



184564
VERRE À BORDEAUX
Bordeaux glass
copa de Cava
65 cl
Ø 9,4 x h 23,9 cm
22 oz
Ø 3 in^{11/16} x h 9 in^{7/16}



184565
VERRE À BOURGOGNE
Burgundy glass
vaso Bourgogne
75 cl
Ø 10,7 x h 22,5 cm
25 oz^{3/8}
Ø 4 in^{3/16} x h 8 in^{7/8}



184562





184580
FLÛTE À CHAMPAGNE
Champagne flute
flauta Champán
21 cl
Ø 7 x h 21 cm
7 oz^{1/8}
Ø 2 in^{3/4} x h 8 in^{1/4}

184578
VERRE À VIN
wine glass
copa de vino
20 cl
Ø 7 x h 17,4 cm
6 oz^{3/4}
Ø 2 in^{3/4} x h 6 in^{7/8}

184577
VERRE À VIN BLANC
white wine glass
copa de vino blanco
25 cl
Ø 7,5 x h 18,4 cm
8 oz^{7/16}
Ø 2 in^{15/16} x h 7 in^{1/4}

184576
VERRE À VIN ROUGE
red wine glass
copa de vino tinto
32 cl
Ø 7,8 x h 19,8 cm
10 oz^{13/16}
Ø 3 in^{1/16} x h 7 in^{13/16}

184575
VERRE À EAU
water glass
copa de agua
42 cl -
8,7 x h 20,5 cm
14 oz^{3/16}
Ø 3 in^{7/16} x h 8 in^{1/16}

184579
VERRE À BOURGOGNE
Burgundy glass
copa Bourgogne
58 cl
Ø 10 x h 20 cm
19 oz^{5/8}
Ø 3 in^{15/16} x h 7 in^{7/8}

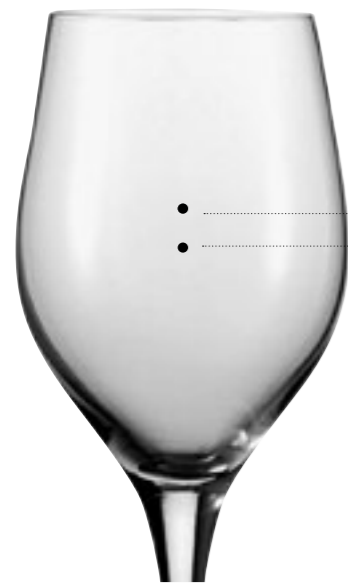

• 14 CL
• 12,5 CL

• AVEC DOUBLE JAUGE
WITH 2 GAUGES
CON DOBLE INDICADOR
DE NIVEL



208481
VERRE À VIN ROUGE
AVEC DOUBLE JAUGE
red wine glass with 2 gauge
copa de vino tinto con doble indicador
de nivel
32 cl - Ø 7,8 x h 19,8 cm
10 oz^{13/16} - Ø 3 in^{1/16} x h 7 in^{13/16}



184576



DÉCANTEUR - DECANTER - DECANTADOR

DÉCANTEURS
CARAFES



169728
DÉCANTEUR MILLÉSIME
decanter
decantador
1,35 l - Ø 20,5 x h 23,5 cm
45 oz^{5/8} - Ø 8 in^{1/16} x h 9 in^{1/4}

188969
DÉCANTEUR VINDÉMIA
decanter
decantador
1,35 l - Ø 23 x h 24 cm
45 oz^{5/8} - Ø 9 in^{1/16} x h 9 in^{7/16}

210904
DÉCANTEUR NECTAR
decanter
decantador
1,1 l - Ø 13,5 x h 24,5 cm
33 oz^{13/16} - Ø 5 in^{5/16} x h 9 in^{5/8}

CARAFE - JARRA



199027
CARAFE À WHISKY ANYTIME
whisky carafe
jarra de whisky
1,2 l - Ø 9,5 x h 26 cm
40 oz^{9/16} - Ø 3 in^{3/4} x h 10 in^{1/4}



202639
EVENTO
CARAFE À JUS DE FRUITS
juice/beverage carafe
botello para zumos
1,2 l - Ø 10,5 x h 27,5 cm
40 oz^{9/16} - Ø 4 in^{1/8} x h 10 in^{13/16}



202855
EVENTO
BOUCHON DE CARAFE SILICONE
silicone stopper for carafe
tapón para botella - silicona
Ø 6,5 cm - h 4,2 cm
Ø 2 in^{9/16} x 1 in^{5/8}



210904



CHAMPAGNE - CHAMPÁN



184567
FLÛTE À CHAMPAGNE
Champagne flute
flauta Champán
15 cl - Ø 6,3 x h 19,3 cm
5 oz^{1/16} - Ø 2 in^{1/2} x h 7 in^{5/8}

184597
VERRE À CHAMPAGNE
Champagne glass
flauta Champán
21 cl - Ø 6,8 x h 20,5 cm
7 oz^{1/8} - Ø 2 in^{11/16} x h 8 in^{1/16}

210281
COUPE À CHAMPAGNE
Champagne glass
copa Champán
23 cl - Ø 9,5 x h 14,7 cm
7oz^{3/4} - Ø 3 in^{3/4} x h 5 in^{13/16}

BIÈRE-BEER-CERVEZA



184569
VERRE À BIÈRE
beer glass
vaso cerveza
39 cl - Ø 7,3 x h 17,7 cm
13 oz^{3/16} - Ø 2 in^{7/8} x h 6 in^{15/16}

COCKTAILS - CÓCTELES



195628
VERRE À MARTINI
martini glass
copa de martini
25 cl
Ø 10,6 x h 16,8 cm
8 oz^{7/16}
Ø 4 in^{3/16} x h 6 in^{5/8}

209814
VERRE À MARGARITA
margarita glass
copa margarita
34 cl
Ø 11,1 x h 17,2 cm
11oz^{1/4}
Ø 4in^{3/8} x h 6 in^{3/4}



209815
VERRE À COCKTAIL
cocktail glass
copa cócteles
48 cl
Ø 8 x h 20,9 cm
16 oz^{1/4}
Ø 3in^{1/8} x h 8 in^{1/4}

DIGESTIF - LIQUEUR WINE - DIGESTIVOS



184570
VERRE À COGNAC
cognac glass
vaso coñac
61 cl
Ø 10,4 x h 15,5 cm
20 oz^{5/8}
Ø 4 in^{1/8} x h 6 in^{1/8}

190700
VERRE À PORTO/SHERRY
sherry glass
copa jerez/oporto
10,4 cl
Ø 5,6 x h 16,9 cm
3 oz^{1/2}
Ø 2 in^{3/16} x h 6 in^{5/8}

209813
VERRE À SHOOTER
shot glass
copa shooter
4,5 cl
Ø 4,6 x h 8 cm
1 oz^{1/2}
Ø 1in^{13/16} x h 3 in^{1/8}

VERRINES - APPETIZER GLASS - VASITOS



109439
COUPELLE BRAZIL
appetizer
vaso
30 cl
Ø 13,2 x h 8,7 cm
10 oz^{1/8}
Ø 5 in^{3/16} x h 3 in^{7/16}

184552
GOBELET BAS/ VERRINE MUSE
low tumbler /appetizer glass
vaso bajo / vasitos
15 cl
Ø 6,4 x h 8 cm
5 oz^{1/16}
Ø 2 in^{1/2} x h 3 in^{1/8}

184598
GOBELET BAS/VERRINE LOOP
low tumbler /appetizer glass
vaso bajo / vasitos
19 cl
Ø 6,7 x h 8,1 cm
6 oz^{7/16}
Ø 2 in^{5/8} x h 3 in^{3/16}



181874
VERRINE RONDO
appetizer glass
vasitos
13 cl
Ø 5,5 x h 6 cm
4 oz^{3/8}
Ø 2 in^{3/16} x h 2 in^{3/8}

210811
BOL OSLO
bowl
copa/vasito
30 cl
10 oz^{1/8}

ANYTIME



195628

VERRINES



210811



GOBELET - TUMBLER - VASO



184555
GOBELET HAUT
high tumbler
vaso alto
36 cl - Ø 6,8 x h 14,2 cm
12 oz^{3/16} - Ø 2 in^{11/16} x h 5 in^{9/16}



184554
GOBELET BAS
low tumbler
vaso bajo
33 cl - Ø 8,0 x h 10,2 cm
11oz^{3/16} - Ø 3 in^{1/8} x h 4 in



184553
GOBELET BAS
low tumbler
vaso bajo
23 cl - Ø 7,6 x h 9,2 cm
7oz^{3/4} - Ø 3 in x h 3 in^{5/8}



184552
GOBELET BAS/VERRINE
low tumbler/appetizer glass
vaso bajo/vasitos
15 cl - Ø 6,4 x h 8 cm
5 oz^{1/16} - Ø 2 in^{1/2} x h 3 in^{1/8}



MUSE
FINEDINING



184554



184601
GOBELET HAUT
high tumbler
vaso alto
39 cl - Ø 6,6 x h 14,5 cm
13 oz^{3/16} - Ø 2 in^{5/8} x h 5 in^{11/16}



184600
GOBELET BAS
low tumbler
vaso bajo
35 cl - Ø 7,9 x h 9,1 cm
11oz^{13/16} - Ø 3 in^{1/8} x h 3 in^{9/16}



184598
GOBELET BAS/VERRINE
low tumbler/appetizer glass
vaso bajo/vasitos
19 cl - Ø 6,7 x h 8,1 cm
6 oz^{7/16} - Ø 2 in^{5/8} x h 3 in^{3/16}



LOOP
ALLDAYDINING



184600



189775
GOBELET HAUT
high tumbler
vaso alto
45 cl - Ø 6,6 x h 17,8 cm
15 oz^{3/16} - Ø 2 in^{5/8} x h 7 in



184589
GOBELET HAUT
high tumbler
vaso alto
35 cl - Ø 6,5 x h 14,4 cm
11 oz^{13/16} - Ø 2 in^{9/16} x h 5 in^{11/16}



184588
GOBELET HAUT
high tumbler
vaso alto
29 cl - Ø 7 x h 10,7 cm
9 oz^{13/16} - Ø 2 in^{3/4} x h 4 in^{3/16}



189774
GOBELET BAS
low tumbler
vaso bajo
42 cl - Ø 8,5 x h 10,6 cm
14 oz^{3/16} - Ø 3 in^{3/8} x h 4 in^{3/16}



184586
GOBELET BAS
low tumbler
vaso bajo
32 cl - Ø 8 x h 9,4 cm
10 oz^{13/16} - Ø 3 in^{1/8} x h 3 in^{11/16}



COSMOPOLITAIN
ALLDAYDINING



184586



L'ABUS D'ALCOOL EST DANGEREUX POUR LA SANTÉ - DEGRENNE PROMOTES RESPONSIBLE DRINKING AND DISCOURAGES ALCOHOL MISUSE - EL ABUSO DE ALCOHOL ES PELIGROSO PARA LA SALUD



GOBELET - TUMBLER - VASO



- VERRE SOUFLÉ BOUCHE TEINTÉ DANS LA MASSE
HAND-BLOWN INTEGRALLY DYED GLASS
VASO SOPLADO A BOCA, PINTADO EN MASA



169851
GOBELET HAUT TRANSPARENT
transparent high tumbler
vaso alto transparent
57 cl - Ø 6,7 x h 11,5 cm
19 oz^{3/4} - Ø 2 in^{5/8} x h 4 in^{1/2}



169852
GOBELET BAS TRANSPARENT
transparent low tumbler
vaso bajo transparent
43 cl - Ø 6,1 x h 10 cm
14 oz^{2/16} - Ø 2 in^{3/8} x h 3 in^{15/16}



169854
GOBELET BAS AMÉTHYSTE
amethyste low tumbler
vaso bajo malva
43 cl - Ø 6,1 x h 10 cm
14 oz^{2/16} - Ø 2 in^{3/8} x h 3 in^{15/16}



169856
GOBELET BAS HÉMATITE
hematite low tumbler
vaso bajo gris
43 cl - Ø 6,1 x h 10 cm
14 oz^{2/16} - Ø 2 in^{3/8} x h 3 in^{15/16}



- VERRE SOUFLÉ BOUCHE TEINTÉ DANS LA MASSE
HAND-BLOWN INTEGRALLY DYED GLASS
VASO SOPLADO A BOCA, PINTADO EN MASA



225516
GOBELET ROUGE
red tumbler
vaso rojo
29 cl - Ø 7,2 x h 9,5 cm
9 oz^{13/16} - Ø 2 in^{13/16} x h 3 in^{3/4}



180936
GOBELET NOIR
black tumbler
vaso negro
29 cl - Ø 7,2 x h 9,5 cm
9 oz^{13/16} - Ø 2 in^{13/16} x h 3 in^{3/4}



180939
GOBELET BLANC
white tumbler
vaso blanco
29 cl - Ø 7,2 x h 9,5 cm
9 oz^{13/16} - Ø 2 in^{13/16} x h 3 in^{3/4}



206936
GOBELET TRANSPARENT
transparent tumbler
vaso transparente
29 cl - Ø 7,2 x h 9,5 cm
9 oz^{13/16} - Ø 2 in^{13/16} x h 3 in^{3/4}



199461
GOBELET BLEU NUIT
blue night tumbler
vaso azul
29 cl - Ø 7,2 x h 9,5 cm
9 oz^{13/16} - Ø 2 in^{13/16} x h 3 in^{3/4}



199462
GOBELET VERT POMME
apple green tumbler
vaso verde
29 cl - Ø 7,2 x h 9,5 cm
9 oz^{13/16} - Ø 2 in^{13/16} x h 3 in^{3/4}



174510
GOBELET CASSIS
purple tumbler
vaso púrpura
29 cl - Ø 7,2 x h 9,5 cm
9 oz^{13/16} - Ø 2 in^{13/16} x h 3 in^{3/4}



225517
GOBELET GRIS
grey tumbler
vaso gris
29 cl - Ø 7,2 x h 9,5 cm
9 oz^{13/16} - Ø 2 in^{13/16} x h 3 in^{3/4}

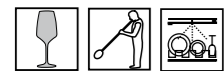

DOLCE
FINEDINING



169852

ALLEGRO
ALLDAYDINING



180936

GOBELET - TUMBLER - VASO



MAMBO
ALLDAYDINING

- VERRE SOUFFLÉ BOUCHE TEINTÉ DANS LA MASSE
HAND-BLOWN INTEGRALLY DYED GLASS
VASO SOPLADO A BOCA, PINTADO EN MASA



171631
GOBELET GRIS
grey tumbler
vaso gris
34 cl - Ø 8,5 x h 10 cm
11oz^{1/2} - Ø 3in^{3/8} x h 3in^{15/16}

171632
GOBELET VERT
green tumbler
vaso verde
34 cl - Ø 8,5 x h 10 cm
11oz^{1/2} - Ø 3in^{3/8} x h 3in^{15/16}

171633
GOBELET VIOLET
purple tumbler
vaso violeta
34 cl - Ø 8,5 x h 10 cm
11oz^{1/2} - Ø 3in^{3/8} x h 3in^{15/16}

171630
GOBELET ROUGE
red tumbler
vaso rojo
34 cl - Ø 8,5 x h 10 cm
11oz^{1/2} - Ø 3in^{3/8} x h 3in^{15/16}



171631



BILBAO
ALLDAYDINING

- VERRE SOUFFLÉ BOUCHE TEINTÉ DANS LA MASSE
HAND-BLOWN INTEGRALLY DYED GLASS
VASO SOPLADO A BOCA, PINTADO EN MASA

NEW

NEW

NEW



230891
GOBELET BASALTE
grey tumbler
vaso gris
30 cl - Ø 8,8 x h 8,8 cm
10 oz^{1/8} - Ø 3 in^{7/16} x h 3 in^{7/16}

230890
GOBELET SABLE ROSE
pink tumbler
vaso rose
30 cl - Ø 8,8 x h 8,8 cm
10 oz^{1/8} - Ø 3 in^{7/16} x h 3 in^{7/16}

230889
GOBELET BLEU DE ROCHE
blue tumbler
vaso azul
30 cl - Ø 8,8 x h 8,8 cm
10 oz^{1/8} - Ø 3 in^{7/16} x h 3 in^{7/16}

EMPILABILITÉ
STACKABLE
APILAMIENTO



230889



LE BUFFET - THE BUFFET - EL BUFET

CONSTRUIRE VOTRE BUFFET EVENTO

DEGRENNÉ présente Evento, une gamme complète dédiée au buffet, pensée pour s'adapter à chaque établissement grâce à un design harmonieux, fonctionnel et personnalisable à l'envie. Grâce à sa modularité, la collection s'adapte à tous vos besoins : du petit-déjeuner au dîner, des buffets sucrés aux buffets salés. La richesse des combinaisons et la diversité des matériaux (acier, porcelaine, verre, bois) permettent de créer un buffet unique qui s'adapte à tous les menus, toutes les saisons, quels que soient votre style et la taille de votre établissement.

DESIGN YOUR BUFFET EVENTO

DEGRENNÉ is presenting Evento, a comprehensive buffet range able to adapt to each eating establishment because of its harmonious, functional and truly personalized design. The flexible Evento range adapts to all of your needs – from breakfast to dinner and from sweet to savoury buffets. The wealth of combinations and the diverse range of materials used (steel, porcelain, glass, wood) help you to create a unique buffet suited to all menus and all seasons whatever the style and size of your eating establishment.

CONSTRUIR SU BUFET EVENTO

DEGRENNÉ presenta Evento, una gama completa dedicada al bufet, pensada para adaptarse a cada establecimiento gracias a un diseño armonioso, funcional y personalizable a su gusto. Gracias a su modularidad, la colección se adapta a todas sus necesidades: desde el desayuno a la comida, de los bufets dulces a los salados. La riqueza de las combinaciones y la diversidad de los materiales (acero, porcelana, cristal, madera) permiten crear un bufet único que se adapta a todos los menús, todas las temporadas independientemente de su estilo y del tamaño de su establecimiento.



©Patrick ROUGEREAU



EVENTO CHAFING DISH

LE CHAFING DISH, PAR SON DESIGN CONTEMPORAIN ALLIANT ACIER, PORCELAINE ET VERRE OFFRE À VOTRE BUFFET UNE PRÉSENTATION SOIGNÉE ET RAFFINÉE.

The chafing dish, with its contemporary design that combines steel, porcelain and glass, brings a smart and sophisticated touch to your buffet display.

El Chafing dish, por su diseño contemporáneo que combina acero, porcelana y cristal ofrece a su buffet una presentación cuidada y refinada.

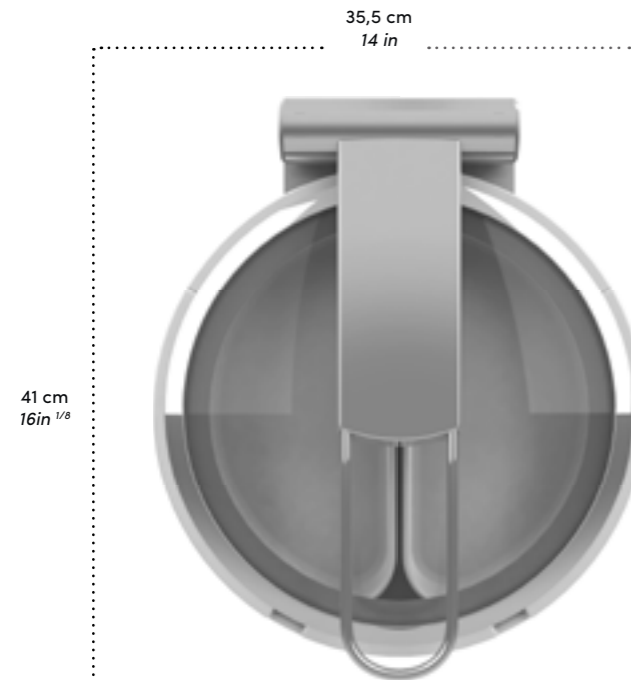

Ø 35,5 cm - P 41 cm - H 15 cm
Ø 14 in - D 16 1/8 in - H 5 7/8 in



COUVERCLE EN VERRE TRANSPARENT POUR PERCEVOIR LE CONTENU ET RENDRE LE BUFFET PLUS GOURMAND

Clear glass cover allows contents to be viewed instantly and makes the buffet more enticing

Cubierta de vidrio transparente permite que el contenido pueda ser visto instantáneamente y hace que el buffet más atractivo

CHARNIÈRE AVEC VÉRIN ET AMORTISSEUR POUR UN RÉEL CONFORT D'UTILISATION ET UNE FERMETURE EN DOUCEUR

The hydraulic buffering hinge offers user comfort and convenience with its soft closure mechanism

La bisagra con amortiguación hidráulica ofrece al usuario comodidad y conveniencia con su mecanismo de cierre suave



ENCOCHES POUR LES COUVERTS DE SERVICE

The notch for the serving cutlery

El agua condensada se recoge mediante un sistema de la ranura para las piezas de servicio

SYSTÈME DE RÉCUPÉRATION D'EAU DE CONDENSATION

Condensation water collection system in the porcelain insert

El agua condensada se recoge mediante un sistema de recolección en la base de porcelana

COMPATIBLE PLAQUE INDUCTION, AVEC RÉSISTANCE ÉLECTRIQUE OU PORTE-BRÛLEUR AVEC GEL COMBUSTIBLE

Compatible with induction, electrical and/or «sterno» fuel heating system

Compatible con induccion, eléctrico o sistema de color externo



CHAFING DISH FINITION MIROIR - CHAFING DISH MIRROR FINISH
CHAFING DISH ACABADO BRILLO
Acier inoxydable, couvercle avec gouttière, verre trempé
 stainless steel, lid with groove tempered glass
 acero inoxidable, tapa con canalón vidrio templado

215722 - BAC PORCELAINE INCLUS
porcelain insert included
 bandeja de porcelana

216143 - BAC ACIER INCLUS
stainless steel insert included
 bandeja de acero inoxidable



CHAFING DISH FINITION BROSSÉE - CHAFING DISH BRUSHED FINISH
CHAFING DISH ACABADO SATINADO
Acier inoxydable, couvercle avec gouttière, verre trempé
 stainless steel, lid with groove tempered glass
 acero inoxidable, tapa con canalón vidrio templado

215723 - BAC PORCELAINE INCLUS
porcelain insert included
 bandeja de porcelana

216144 - BAC ACIER INCLUS
stainless steel insert included
 bandeja de acero inoxidable



202635 - 1/2 BAC PORCELAINE POUR CHAFING DISH
1/2 chafing porcelain insert
 1/2 bandeja de porcelana para chafing
 L 29 x l15 x H 4,5 cm - contenance 1L
 11in 7/16 x 5 in 7/8 x 1 in 3/4 - capacity 33 oz 13/16

RÉSISTANCE AVEC RÉGULATEUR DE TEMPÉRATURE
 202860 - 220 /240 V
 203468 - 110 /120 V
heating element - heat adjustable
 resistencia con regulador de temperatura
 20 x 20 cm - 7 in 7/8 x 7 in 7/8

SUPPORT CHAFING
ACIER INOXYDABLE, POUR RÉSISTANCE ÉLECTRIQUE
OU PORTE-BRÛLEUR AVEC GEL COMBUSTIBLE
chafing stand stainless steel, for electrical and/or sterno heating purposes
 soporte para chafing dish acero inoxidable para resistencia eléctrica o calentador externo
 Ø 35 cm - P 40 cm - H 12,5 cm
 Ø 13 in 3/4 x d 15 in 3/4 x h 4 in 15/16

203005 - FINITION MIROIR
mirror finish
 acabado brillo

202859 - FINITION BROSSÉE
brushed finish
 acabado satinado

202861 - PORTE-BRÛLEUR POUR GEL COMBUSTIBLE ACIER
burner holder steel
 quemador acero inoxidable
 Ø 9 cm - H 6 cm - Ø 3 in 9/16 x 2 in 3/8

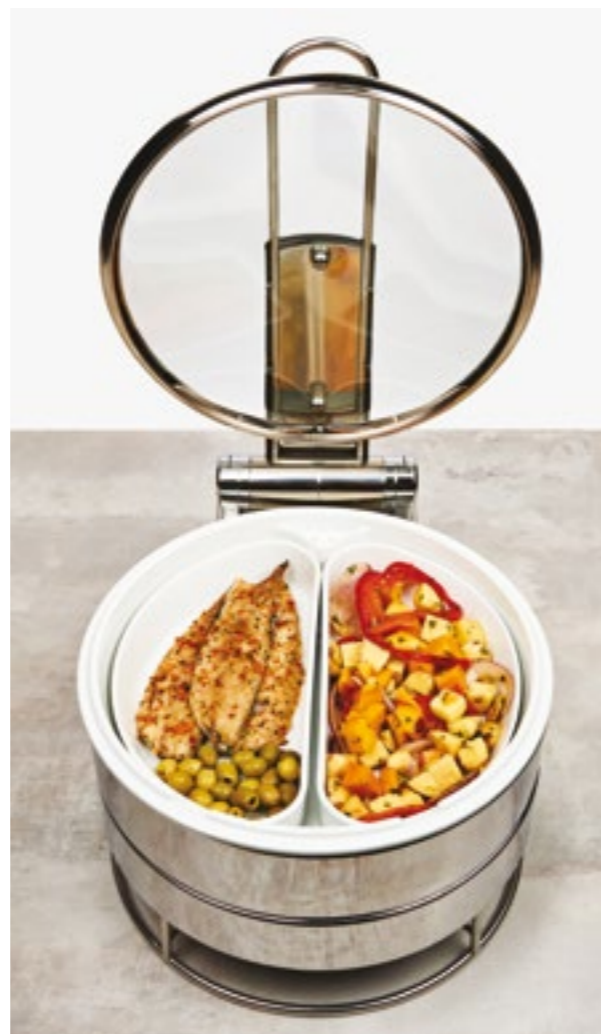

ACCESSOIRES - ACCESSORIES - ACCESORIOS

SUPPORT COUVERTS DE SERVICE - PORCELAINE

203332 - COLORIS NOIR
serving cutlery display black porcelain
 soporte para piezas de servicio porcelana negra

202633 - COLORIS BLANC
serving cutlery display white porcelain
 soporte para piezas de servicio porcelana blanca
 21 x 10 x 5 cm - 8 in 1/4 x 3 in 15/16 x 1 in 15/16



204499 184355
PINCE À SERVIR
serving tong
 pinzas para servir
 29,5 cm - 11 in 5/8



130994
CUILLER À TOAST
appetizer spoon
 cuchara aperitivo
 11,8 cm - 4 in 5/8



168845
CUILLER À SPAGHETTI
spaghetti serving spoon
 cuchara para espaguetis
 29 cm - 11 in 7/16

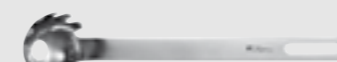

168846
LOUCHETTE
gravy ladle
 cucharón
 29 cm - 11 in 7/16



168844
FOURCHETTE À VIANDE
meat fork
 tenedor de carne
 29 cm - 11 in 7/16



168843
CUILLER DE SERVICE
serving spoon
 cuchara de servicio/ensalada
 32 cm - 12 in 5/8

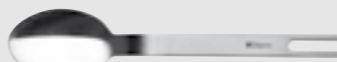



L 56,5 x P 36 x H 9,5 cm
22 in^{1/4} x 14 in^{3/16} x 3 in^{3/4}

LE MODULE RÉFRIGÉRÉ REÇOIT UNE LARGE GAMME DE CONTENANTS, PLATEAUX ET ACCESSOIRES MULTI-MATÉRIAUX AU FORMAT GN. (PORCELAINE, VERRE, ARDOISE, ACIER, BAMBOU, ACRYLIQUE) QUI PERMETTENT UNE INFINITÉ DE COMBINAISONS.

The refrigerated unit will hold a wide range of platters and multi-material accessories in Industry standard format (porcelain, glass, slate, acrylic, etc.), allowing endless combinations.

El módulo refrigerado presenta una amplia variedad de bandejas y accesorios de múltiples materiales en formato GN (Porcelana, vidrio, pizarra, acrílico, ...) que permiten un número infinito de combinaciones.

MODULE ACIER + BAC PLASTIQUE
refrigerated set + plastic tray
modulo de acero + bandeja

202864 - FINITION MIROIR
stainless steel mirror
acabado brillo



202871 - COUVERCLE MODULE RÉFRIGÉRÉ
POIGNÉE INOXYDABLE
lid for refrigerated set/stainless steel handle
cubierta para el modulo refrigerado/asa
acero inoxidable
56 x 35 x 19 cm
22 in^{1/16} x 13 in^{3/4} x 7 in^{1/2}



202865 - FINITION BROSSÉE
stainless steel brushed
acabado satinado



208357 - PLAQUE RÉFRIGÉRANTE EUTECTIQUE
black cooling block, eutectique
negro acumulador de refrigeracion
48 x 28 x 3 cm
18 in^{7/8} x 11 in x 1 in^{3/16}



202869 - NOIR MÉTALLISÉ
metallic black
acabado negro metalico















202866 - BAC PLASTIQUE
plastic tray
bandeja
56 x 35,5 x 8 cm
22 in^{1/16} x 14 in x 3 in^{1/8}



©Patrick ROUGEREAU



REFRIGERATED UNIT MODULO REFRIGERADO	GN 1/1 53 x 32,5 cm 20 in ^{7/8} x 12 in ^{13/16}	GN 2/3 35,5 x 32,5 cm 14 in x 12 in ^{13/16}	GN 1/2 26,5 x 32,5 cm 10 in ^{7/16} x 12 in ^{13/16}	GN 1/3 17,5 x 32,5 cm 6 in ^{7/8} x 12 in ^{13/16}
PLATEAU BAMBOU ÉPAISSEUR 1,5 CM oiled bamboo tray thickness 9/16 bandeja bamboo grosor 1,5 cm	 202919	 202920		
PLATEAU PORCELAINE white enamelled porcelain tray bandeja porcelana		 202628	 202629	 202627 202630 PLAT CREUX deep dish bandeja
PLATEAU ACIER 18-10 FINITION STANDARD STAINLESS STEEL 18-10 serving tray without handle, standard finish bandeja rectangular sin asa acero 18-10, acabado standard	 202873			
PLATEAU ACIER 18-10 NEWPORT FINITION MIROIR stainless steel 18-10 serving tray without handle, mirror finish bandeja rectangular sin asa acero 18-10 acabado brillo	 185021		 185019	
PLATEAU VERRE ÉPAISSEUR 0,6 CM tempered glass tray thickness 1/4 bandeja cristal grosor 0,6 cm	 230752	 230753		
PLATEAU ACRYLIQUE ÉPAISSEUR 1 CM acrylic tray thickness 3/8 Bandeja acrílico grosor 1 cm	 230756 - 2 TROUS 2 holes - 2 agujeros adapté aux bols 22 cm adapted for bowls 8,6 inch adaptados a boles de 22 cm		 230755 - 1 TROU 1 hole - 1 agujero adapté aux bols 22 cm adapted for bowls 8,6 inch adaptados a boles de 22 cm	 230757 - 2 TROUS 2 holes - 2 agujeros adapté aux bols 14 cm adapted for bowls 5,5 inch adaptados a boles de 14 cm

ACCESSOIRES - ACCESSORIES - ACCESORIOS

202632 - ÉTIQUETTE PORCELAINE
AVEC AIMANT+ SUPPORT ACIER
porcelain stick + stainless steel stand
with magnet
etiqueta porcelana + soporte acero inox
con imán
10 x 5 cm - 3 in^{15/16} x 1 in^{15/16}



230337 - BOL EVENTO GRIS PERLE
grey evento bowl
bol evento gris
22 cm - 8 in^{11/16}

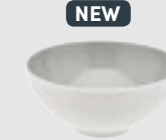

NEW

183340 - PLANCHE À DÉCOUPER BAMBOU
bamboo cutting board
tabla de cortar bamboo
35 x 26,5 cm
13 in^{3/4} x 10 in^{7/16}



216496 - STRAT - 6 ASSIETTES
EMPILÉES + SOCLE
6 stackable plates + thick app.plate/stand
6 platos apilados + base
Ø 16 cm - Ø 6 in^{5/16}



154245 - BOL MODULO BLANC
white modulo bowl
bol modulo blanco
14 cm - 5 in^{1/2}



216494 - STRAT - ASSIETTE RONDE
round stackable plate
plato rondo
Ø 16 cm - Ø 6 in^{5/16}



202625 - BOL EVENTO BLANC
white evento bowl
bol evento blanco
22 cm - 8 in^{11/16}



216495 - STRAT - SOCLE GRÈS
thick app. plate black satin finish
ceramic base
Ø 16 cm - H 5 cm - Ø 6 in^{5/16} - H 1 in^{5/16}



POSSIBILITÉ D'AIMANTER L'ÉTIQUETTE PORCELAINE SUR LE MODULE FROID
Magnetic porcelain name plate accessory for refrigerated unit placement
Placa de porcelana magnética para colocar los nombres



URNE À JUS DE FRUITS 4L - ACIER 18-10
juice dispenser 135 oz stainless steel
 dispensador de zumo acero
231303 - MIROIR
mirror
 acabado brillo
231304 - BROSSÉ
brushed
 acabado satinado

L 20 cm - P 32 cm - H 45 cm
 W 7 in^{7/8} - D 12 in^{5/8} - H 17 in^{11/16}

URNE À JUS DE FRUIT DOTÉE D'UN TUBE CENTRAL EN ACIER POUR GLACE PILÉE : PARFAIT MAINTIEN DE LA FRAÎCHEUR

Fruit juice urn with central steel tube to hold crushed ice, for perfect freshness

Dispensador de zumos dotado con un tubo central de acero para hielo picado para mantener la frescura

ACCESSOIRES - ACCESSORIES - ACCESORIOS

202855
BOUCHON DE CARAFE SILICONE
stopper for carafe - silicone
 tapón para botella - silicona
 Ø 6,5 cm - H 4,2 cm
 Ø 2 in^{9/16} x h 1 in^{5/8}



202632 - ETIQUETTE PORCELAINE
AVEC AIMANT+ SUPPORT ACIER
porcelain stick + stainless steel stand
 with magnet
 etiqueta porcelana + soporte acero inox
 con imán
 10 x 5 cm - 3 in^{15/16} x 1 in^{15/16}



202639 - CARAFE À JUS DE FRUIT
VERRE -1,2 L
CRISTALLIN SOUFLÉ BOUCHE
juice/beverage carafe
 40 oz ^{9/16}
 hand blown crystalline
 botella para zumos
 cristal soplado en boca
 Ø 10,5 cm - H 27,5 cm
 Ø 4 in^{1/8} x h 10 in^{13/16}



BOUCHON VERSEUR EN SILICONE,
POUR UNE MEILLEURE HYGIÈNE

Hygienic silicone pouring stopper

Tapón de silicona para mayor higiene
 y control del vertido



©Patrick ROUGEREAU

CEREAL DISPENSER-DISPENSADOR DE CEREALES

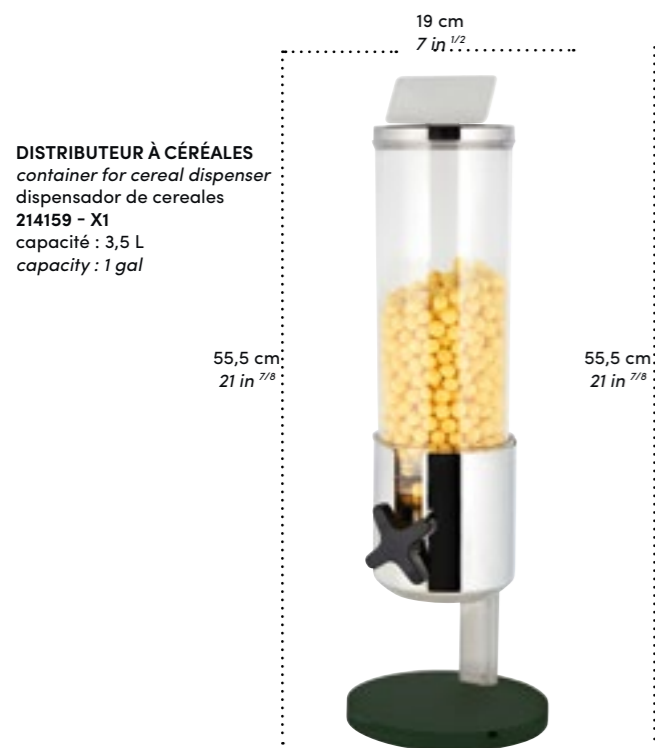

DISTRIBUTEUR À CÉRÉALES
 container for cereal dispenser
 dispensador de cereales
 214159 - X1
 capacité : 3,5 L
 capacity : 1 gal

55,5 cm
21 in^{7/8}

119 x p 20 x h 55,5 cm
 w 7 in^{1/2} x d 7 in^{7/8} x h 21 in^{7/8}



DISTRIBUTEUR À CÉRÉALES
 container for cereal dispenser
 dispensador de cereales
 214160 - X3
 capacité : 3 x 3,5 L
 capacity : 3 x 1 gal

50 cm
19 in^{11/16}

150 x p 20 x h 55,5 cm
 w 19 in^{11/16} x d 7 in^{7/8} x h 21 in^{7/8}

EVENTO DISTRIBUTEUR À CÉRÉALES

DISTRIBUTEUR À CÉRÉALES AVEC AILETTES SOUPLES POUR NE PAS CASSER LES CÉRÉALES

Cereal dispenser with flexible spout so as not to break the cereals

Dispensador de cereales con pestañas flexibles para no romper los cereales

ACCESSOIRES - ACCESSORIES - ACCESORIOS

202855
BOUCHON DE CARAFE SILICONE
 stopper for carafe - silicone
 tapón para boltella - silicona
 Ø 6,5 cm - H 4,2 cm
 Ø 2 in^{9/16} x h 1 in^{5/8}



202636 - CARAFE À LAIT
PORCELAINE -1,2 L
 porcelain milk jug - 40 oz^{9/16}
 boltella para leche
 porcelana
 Ø 10,5 cm - H 27,5 cm
 Ø 4 in^{1/8} x h 10 in^{13/16}

202632 - ÉTIQUETTE PORCELAINE
AVEC AIMANT+ SUPPORT ACIER
 porcelain stick + stainless steel stand
 with magnet
 etiqueta porcelana + soporte acero inox
 con imán
 10 x 5 cm - 3 in^{15/16} x 1 in^{15/16}



202626 - BOL EMPILABLE
 porcelain stackable bowl
 bol porcelana apilable
 14 cm - 5 in^{1/2}



BOUCHON VERSEUR
EN SILICONE,
POUR UNE MEILLEURE
HYGIÈNE

Hygienic silicone
 pouring stopper

Tapón de silicona
 para mayor higiene y
 control del vertido

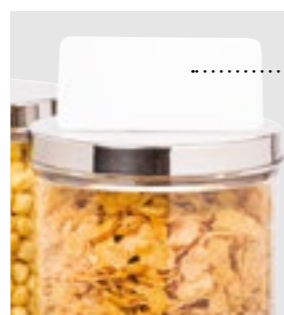

POSSIBILITÉ
D'AIMANTER
L'ÉTIQUETTE
PORCELAINE
SUR LE COUVERCLE

Magnetic porcelain
 name plate accessory
 for lid placement

Placa de porcelana
 magnética para
 colocar los nombres



© Patrick ROUGER/ALU

183



RECTANGULAR TRAY - SOPORTE RECTANGULAR



54 cm
21in^{1/4}

73 cm
28 in^{3/4}

PANIÈRE REVERSIBLE POUR UNE PRÉSENTATION DROITE OU INCLINÉE
Reversible basket for a level or tilted display
Panera reversible para una presentacion derecha o inclinada



230741
SUPPORT RECTANGULAIRE NIVEAU 1 **NEW**
rectangular tray, level 1
soporte rectangular, nivel 1
L 44 x P 30,8 x H 10,8 cm
w 17 in^{5/16} x d 12 in^{1/8} x h 4 in^{1/4}



230742
SUPPORT RECTANGULAIRE NIVEAU 2 **NEW**
rectangular tray, level 2
soporte rectangular, nivel 2
L 42 x P 30,8 x H 29,8 cm
w 16 in^{5/16} x d 12 in^{1/8} x h 11 in^{3/4}

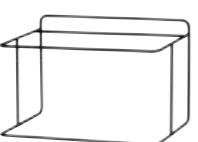

230741 + 230742
SUPPORT RECTANGULAIRE NIVEAU 1+2 **NEW**
rectangular tray, level 1+2
soporte rectangular, nivel 1+2
L 44 x P 50 x H 29,8 cm
w 17 in^{5/16} x d 19 in^{11/16} x h 11 in^{3/4}

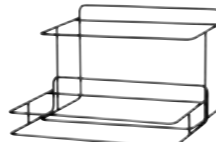

230743
SUPPORT RECTANGULAIRE NIVEAU 3 **NEW**
rectangular tray, level 3
soporte rectangular, nivel 3
L 40 x P 30,8 x H 48,8 cm
w 15 in^{3/4} x d 12 in^{1/8} x h 19 in^{3/16}

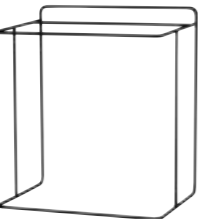

230742 + 230743
SUPPORT RECTANGULAIRE NIVEAU 2+3 **NEW**
rectangular tray, level 2+3
soporte rectangular, nivel 2+3
L 42 x P 50 x H 48,8 cm
w 16 in^{9/16} x d 19 in^{11/16} x h 19 in^{3/16}



230741 + 230742 + 230743
SUPPORT RECTANGULAIRE NIVEAU 1+2+3 **NEW**
rectangular tray, level 1+2+3
soporte rectangular, nivel 1+2+3
L 44 x P 68,2 x H 48,8 cm
w 17 in^{5/16} x d 26 in^{7/8} x h 19 in^{3/16}



230744 - CADRE ACIER POUR SUPPORT RECTANGULAIRE **NEW**
steel frame for stand
estructura de acero
L 55,5 x P 35 x h 4,5 cm
w 21in^{7/8} x d 13 in^{3/4} x h 1in^{3/4}



230749
PANIÈRE RECTANGULAIRE - GN 1/1 **NEW**
rectangular bread basket
cesta bollería rectangular
54 x 34 x h 7 cm
21in^{1/4} x 13 in^{3/8} x 2 in^{3/4}



202919-PLATEAU BAMBOU - GN 1/1
oiled bamboo tray
bandeja bamboo



230752-PLATEAU VERRE - GN 1/1
tempered glass tray
bandeja cristal



PLATEAU ACIER 18-10 - GN 1/1
serving tray
bandeja rectangular



185021
FINITION MIROIR - mirror finish
acabado brillo



202873
FINITION STANDARD - standard finish
acabado standard

EVENTO SUPPORT FIL RECTANGULAIRE

DES SUPPORTS EN ACIER NOIR MAT DE HAUTEURS DIFFÉRENTES POUR RYTHMER LES PRÉSENTATIONS

Black mat finish supports of differing heights can be used to create a varied presentation

Soportes de acero negro de diferentes alturas para marcar el ritmo de las presentaciones



©Patrick ROUGEREAU



230745
SUPPORT ROND BAS **NEW**
round stand, low level
soporte redondo bajo
Ø 25 cm x h 13 cm
Ø 9 in^{13/16} x h 5 in^{1/8}



Ø 25 cm x h 13 cm
Ø 9 in^{13/16} x h 5 in^{1/8}

230746
SUPPORT ROND HAUT **NEW**
round stand, high level
soporte redondo alto
Ø 25 cm x h 26 cm
Ø 9 in^{13/16} x h 10 in^{1/4}



Ø 25 cm x h 26 cm
Ø 9 in^{13/16} x h 10 in^{1/4}

230748
PANIÈRE RONDE **NEW**
round bread basket
cesta bollería redonda
Ø 32 cm x h 8 cm
Ø 12 in^{5/8} x h 3 in^{1/8}



230750
PANIÈRE INDIVIDUELLE **NEW**
individual bread basket
cesta bollería individual
Ø 18 cm x h 6 cm
Ø 7 in^{1/16} x h 2 in^{3/8}



230754
PLATEAU VERRE GRIS ROND **NEW**
grey round tempered glass
bandeja cristal redonda
Ø 32 cm
Ø 12 in^{5/8}



136524
PLATEAU ROND PORCELAINE MODULO
pie/pizza plate, flat
fuente para pastel
Ø 32 cm - 12 in^{5/8}



142722
BOL PORCELAINE MODULO
deep bowl, large
bol hondo
Ø 28 cm - épaisseur : 8 mm
Ø 11 in - thickness : in^{5/16}
espesor : 8 mm



ACCESSOIRES - ACCESSORIES - ACCESORIOS

214185
COUPE ACIER
stainless steel bowl
tazón acero
Ø 11,5 cm - Ø 4 in^{1/2}



214182
PRÉSENTOIR ACIER MIROIR 3 TROUS
three holes stainless steel stand mirror finish
expositor de acero en brillo 3 agujeros
41 x 12,5 x 2,3 cm - 16 in^{1/8} x 4 in^{15/16} x 7/8



202631
PRÉSENTOIR DE TABLE EN PORCELAINE
porcelain table center piece
pieza de porcelana centro de mesa
15,5 x 7,5 cm - 6 in^{1/8} x 2 in^{15/16}

202854
PLANCHE À PAIN BAMBOU AVEC RÉCUPÉRATEUR DE MIETTES (GN 1/1) ADAPTABLE AU SUPPORT FROID
bamboo bread board with crumb tray (GN 1/1). Can be used on a cold base (no cooling feature but for appearance purposes if required)
panera bamboo
53 x 32,5 cm - 20 in^{7/8} x 12 in^{13/16}



217814
COUTEAU L'ECONOME ECO NATURE® POSITIONNABLE DANS LA PLANCHE
Econome eco nature® bread knife fits in a slot in the bread board
cuchillo de pan Econome eco nature® se encaja en una ranura de la panera
18 cm - 7 in^{1/16}



204498 **101492**
PINCE À PAIN
bread tong
pinzas pan
23 cm - 9 in^{1/16}



204496 **101494**
CISEAUX À GÂTEAUX
pastry scissors/tong
pinzas para pasteles
20 cm - 7 in^{7/8}



230751
PANIÈRE À BAGUETTE **NEW**
baguette basket
cesta para baguette
27 x 52 cm
10 in^{5/8} x 20 in^{1/2}



PRÉSENTOIRS À GÂTEAUX ROUNDS
round app/pizza/presentation stand
expositor de tartas
209381 - Ø 25 cm - Ø 9 in^{13/16}
209382 - Ø 32 cm - Ø 12 in^{5/8}



©Patrick ROUGEREAU



EVENTO

Vitaminé/ Vitamin/ Vitaminado

Evocateur de fraîcheur, de bien être et de vitalité, il propose les contenants destinés aux laitages, jus de fruits, céréales, fruits secs... Il utilise des matériaux neutres comme le verre, l'acrylique et la porcelaine.

Evocative of freshness, well-being and vitality, it provides containers for dairy products, fruit juices, cereals, dried fruits... It uses neutral materials such as glass, acrylic and porcelain.

Evocador de frescura, bienestar y vitalidad, este buffet propone recipientes para productos lácteos, zumos de frutas, cereales, frutos secos... Utiliza materiales neutros como el vidrio, el acrílico y la porcelana.

EVENTO

Gourmet Salé/Savoury Gourmet/ Gourmet Salado

Les contenants maintiennent au chaud les aliments (bacon, oeufs brouillés, nouilles...) ou au frais (charcuterie, fromage, sushis...). Deux matériaux proches de l'univers culinaire sont privilégiés : l'acier et la porcelaine.

The containers keep foods warm (bacon, scrambled eggs, noodles...) or cold (deli meat, cheese, sushi...). Two materials close to the culinary world are preferred: steel and porcelain.

Los contenedores mantienen calientes los alimentos (tocino, huevos revueltos, fideos...) o frescos (embutidos, queso, sushi...). Dos materiales cerca del universo culinario son privilegiados: el acero y la porcelana.

EVENTO

Gourmand Sucré/Sweet Gourmet/ Gourmet Dulce

Evocateur de tradition et de convivialité, il regroupe les pains, les viennoiseries, les pâtisseries, les confitures, les miels... Il est constitué de contenants à base de matériaux traditionnels : bois, vannerie...

Evocative of tradition and conviviality, it includes breads, viennoiseries, pastries, jams, honeys... It is composed of containers made of traditional materials: wood, basketry...

Evocador de la tradición y la convivencia, este buffet incluye panes, dulces, pasteles, mermeladas, mieles... Está compuesto de contenedores hechos de materiales tradicionales : la madera, la cestería...





35,5 cm
14 in

35,5 cm
14 in

35,5 cm
14 in

35,5 cm
14 in

56,5 cm
22 in^{1/4}

54 cm
21 in^{1/4}

20 cm
7 in^{7/8}

20 cm
7 in^{7/8}

50 cm
19 in^{1/8}

136524
H 26 cm
10 in^{1/4}



202633

209382
Ø 32 cm
Ø 12 in^{5/8}

209381
Ø 25 cm
Ø 9 in^{13/16}



154245

202628

203332

230752

230752

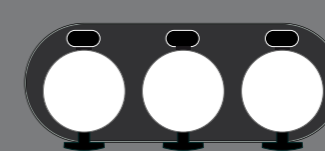

202633



H 26 cm
10 in^{1/4}
230754

230754
H 13 cm
5 in^{1/8}



185019

202629

203332

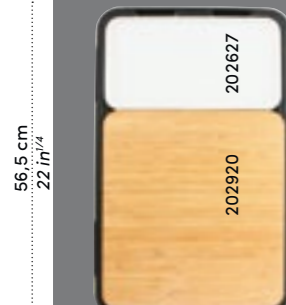

202627

202920

203332



154245

202630

154245

203332

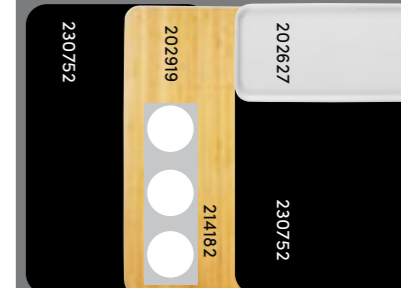

230752

202919

214182

202627

230752



202854

230751
Ø 27 cm
10 in^{5/8}

56,5 cm
22 in^{1/4}

56,5 cm
22 in^{1/4}

56,5 cm
22 in^{1/4}

54 cm - 21 in^{1/4}

53 cm - 20 in^{7/8}



CHAFING DISH

**203470 - COUVERCLE AVEC GOUTTIÈRE
ACIER
ET VERRE TREMPÉ**
lid with stainless steel gutter, tempered glass
tapa en acero inox y vidrio templado
Ø 33 cm - Ø 13 in



215721 - BAC PORCELAINE POUR CHAFING DISH
chafing porcelain insert
bandeja de porcelana para chafing
Ø 35,6 x H 7 cm - contenance 3L
Ø 14 x h 2 in^{3/4} - capacity 100 oz



216142 - BAC ACIER POUR CHAFING DISH
chafing stainless steel insert
bandeja de acero inoxidable para chafing dish
Ø 35,5 x H 6,3 cm - contenance 3L
Ø 14 x h 2 in^{7/8} - capacity 100 oz



202635 - 1/2 BAC PORCELAINE POUR CHAFING DISH
1/2 chafing porcelain insert
1/2 bandeja de porcelana para chafing
L 29 x H 4,5 cm - contenance 1L
11in^{7/16} x 5 in^{7/8} x 1 in^{3/4} - capacity 33 oz^{13/16}



RÉSISTANCE AVEC RÉGULATEUR DE TEMPÉRATURE
202860 - 220 /240 V
203468 - 110 /120 V
heating element - heat adjustable
resistencia con regulador de temperatura
20 x 20 cm - 7 in^{7/8} x 7 in^{7/8}



**SUPPORT CHAFING
ACIER INOXYDABLE, POUR RÉSISTANCE ÉLECTRIQUE OU PORTE-BRÛLEUR AVEC GEL
COMBUSTIBLE**
chafing stand stainless steel, for electrical and/or sterno heating purposes
soporte para chafing dish acero inoxidable para resistencia eléctrica o calentador externo

Ø 35 cm - P 40 cm - H 12,5 cm
Ø 13 in^{3/4} x d 15 in^{3/4} x h 4 in^{15/16}

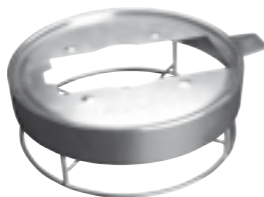

203005 - FINITION MIROIR
mirror finish
acabado brillo

202859 - FINITION BROSSÉE
brushed finish
acabado satinado

**202861 - PORTE-BRÛLEUR POUR GEL COMBUSTIBLE
ACIER**
burner holder steel
quemador acero inoxidable
Ø 9 cm - H 6 cm - Ø 3 in^{9/16} x 2 in^{3/8}



MODULE FROID - REFRIGERATED UNIT - MODULO REFRIGERADO

202866 - BAC PLASTIQUE
plastic tray
bandeja
56 x 35,5 x 8 cm
22 in^{1/16} x 14 in x 3 in^{1/8}

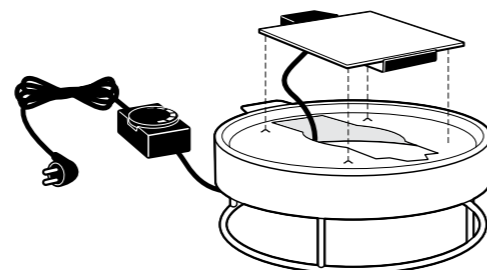
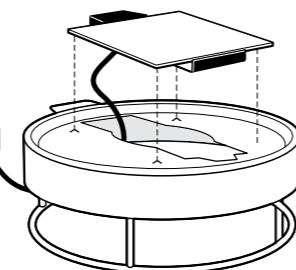
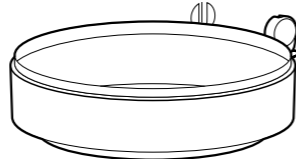

URNE À JUS DE FRUITS FRUIT JUICE URN DISPENSADOR DE ZUMOS

COUVERCLE URNE ACIER 18-10
lid for stainless dispenser 18-10
Ø 17,9 cm - 7 in^{1/16}
202881 - MIROIR
mirror
acabado brillo
202891 - BROSSÉE
brushed
acabado satinado

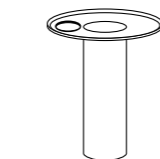
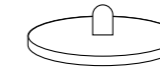

202884
TUBE POUR GLACE
ice tube
tubo para hielo
acier, stainless steel, acero 18-10
Ø 9 cm - 3 in^{9/16}

214724
ROBINET
faucet
grifo
ACIER, stainless steel, acero
+ ABS NOIR, black, negro

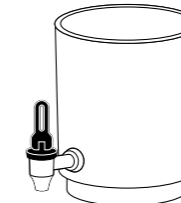

202883
FÛT CYLINDRIQUE URNE
container for dispenser
contenedor para el dispensador san
5l - Ø 17,7 cm x H 25,5 cm
169 oz^{1/16} - Ø 6 in^{15/16} x h 10 in^{1/16}

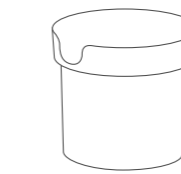

BASE ACIER 18-10 URNE
stainless steel stand for dispenser 18-10
soporte acero para dispensador 18-10
Ø 17,6 cm - H 19 cm
Ø 6 in^{15/16} x h 7 in^{1/2}
202890 - MIROIR
mirror
acabado brillo
202889 - BROSSÉE
brushed
acabado satinado

045963
GRILLE ACIER POUR GOUTTES
steel grid drop collector
rejilla de acero para recoger el goteo
acier, stainless steel, acero 18-10
Ø 9 cm - 3 in^{9/16}

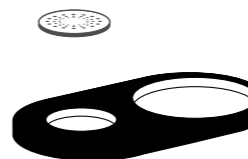

230758
SOCLE NOIR ACRYLIQUE URNE **NEW**
stand for black dispenser
base del dispensador negro
20 x 32 cm
7 in^{7/8} x 12 in^{5/8}
ÉPAISSEUR: 2 CM
thickness: espesor: 13/16 in

DISTRIBUTEUR À CÉRÉALES CEREALS DISPENSER DISPENSADOR DE CEREALES

213078
**COUVERCLE
DISTRIBUTEUR CEREALES
FINITION MIROIR**
lid for cereal dispenser,
mirror finish
tapa para dispensador en brillo
ACIER, stainless steel, acero 18-10
Ø 12,5 cm - Ø 4 in^{15/16}

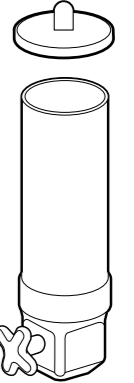

213076
**FUT CYLINDRIQUE AVEC AILETTE
ET POIGNEE DISTRIBUTEUR CEREALES**
barrel + handle + rolling tap
for cereal dispenser
contenedor para el dispensador
con aleta y asa
p 16,1 x h 42 cm - d 6 in^{5/16} x h 16 in^{9/16}

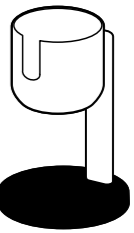

213686
**BASE + TUBE + SOCLE X1
DISTRIBUTEUR A CEREALES**
stainless steel stand + tub
+ acrylic stand for cereal dispenser
base + tubo + zócalo dispensador
de cereales
l 19 x h 27,5 cm - l 7 in^{1/2} x h 29 in^{3/4}

214162
**BASE + TUBE + SOCLE X3
DISTRIBUTEUR A CEREALES**
stainless steel stand + tub
+ acrylic stand for cereal dispenser
base + tubo + zócalo
x3 dispensador de cereales
l 50 x h 27,5 cm - l 19 in^{1/16} x h 29 in^{3/4}

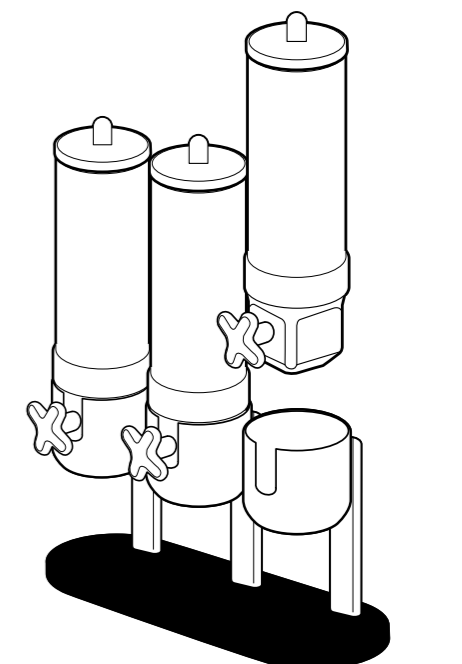

LA CUISINE - KITCHENWARE - COCINA

Véritable tradition pour DEGRENNÉ, le culinaire se décline en ustensiles de cuisson, de préparation, de découpe et d'affûtage, pour inviter les chefs à la réalisation de recettes savoureuses et délicates.

Les gammes coutellerie l'Unique Sabatier ainsi que les ustensiles de préparation de la célèbre marque L'Econome®, sont gages de qualité et témoignent d'un véritable esprit précurseur dans l'histoire de la cuisine française. Experte dans le travail de l'acier et notamment sur l'embouti, DEGRENNÉ présente également Newcook Expert, une gamme d'ustensiles de cuisson 100% fabriquée en France. En alliant précision, technologie Multiply et design, Newcook Expert promet des moments de création uniques.

Kitchenware is a real tradition at DEGRENNÉ and our range comprises cooking, preparation, slicing and sharpening utensils to encourage chefs to make flavoursome and delicate dishes.

The Unique Sabatier cutlery ranges and the famous L'Econome® brand's food preparation utensils, are a guarantee of quality and bear witness to a trailblazing spirit in the history of French cuisine. DEGRENNÉ has steel-working and specifically metal stamping expertise, and is also presenting Newcook Expert, a range of cooking utensils entirely made in France. Newcook Expert promises unique creative moments, as the range combines precision, Multiply technology and great design.

Verdadera tradición para DEGRENNÉ, lo culinario se declina en utensilios de cocción, de preparación, de corte y de afilado, para invitar a los chefs a la preparación de recetas sabrosas y delicadas.

Las gamas de cuchillería, Unique Sabatier, así como los utensilios de preparación de la famosa marca, L'Econome®, son garantía de calidad y dan fe de un verdadero espíritu pionero en la historia de la cocina francesa. Experta en el trabajo del acero, sobre todo en el estampado, DEGRENNÉ también presenta Newcook Expert, una gama de utensilios de cocina, 100 % fabricada en Francia. Aliando precisión, tecnología Multiply y diseño, Newcook Expert promete momentos de creación únicos.



Grâce à leur forme unique et leurs caractéristiques immuables, les collections L'Unique Sabatier incarnent le couteau de cuisine français par excellence. Des couteaux de chefs de qualité professionnelle estampillés «Esprit de Thiers®» 100% made in France.

Through their unique shape and timeless characteristics, the "L'Unique Sabatier" collections embody the ultimate French kitchen knife. These professional quality chef's knives are stamped "Esprit de Thiers®" and 100% made in France.

IDÉAL ALU®

Une collection de couteaux de Chef bien équilibrés et légers grâce à leur mitre en aluminium. Les lames découpées dans des pièces d'acier biseautées sont affûtées avec une grande précision. Des couteaux efficaces qui offrent une grande facilité d'utilisation.

A collection of light and well-balanced knives thanks to their aluminium bolster. The blades are cut in bevelled steel parts and sharpened with great accuracy. Easy to use and effective knives.

IDÉAL FORGÉ®

L'illustration du savoir-faire français dans une collection de couteaux entièrement forgés et fabriqués dans le plus grand respect de la tradition coutelière. Une forme reconnaissable entre toutes.

Illustration of the French expertise in a collection of entirely forged knives which are manufactured according to cutlery tradition. An immediately recognisable shape.

IDÉAL FORGÉ OLIVIER®

Une collection de couteaux entièrement forgés aux manches façonnés en bois d'olivier, matériau noble et naturel pour des couteaux élégants et véritablement uniques.

A collection of entirely forged knives with shaped handles made from olive wood, a noble and natural material for elegant and truly unique knives.



218590
COUTEAU OFFICE
paring knife
 cuchillo mondador
 8 cm - 3 in^{1/8}



218581
COUTEAU À JAMBON
ham slicer
 cuchillo jamonero
 25 cm - 10 in



218587
COUTEAU OFFICE
paring knife
 cuchillo mondador
 10 cm - 4 in



218583
COUTEAU À JAMBON ALVÉOLÉ
ham slicer granton edge -cuchillo jamonero alveolado
 30 cm
 12 in



218585
COUTEAU OFFICE BEC OISEAU
curved blade paring knife
 cuchillo mondador pico de pajaró
 8 cm - 3 in^{1/8}



218626
COUTEAU À DÉOSSER
boning knife
 cuchillo deshuesador
 13 cm - 5 in



218593
COUTEAU DE CUISINE
chef's knife
 cuchillo de cocina
 15 cm - 6 in



218628
COUTEAU À DÉOSSER
boning knife
 cuchillo deshuesador
 15 cm - 6 in



218596
COUTEAU DE CUISINE
chef's knife
 cuchillo de cocina
 20 cm - 8 in



217880
FUSIL
sharpening steel
 afilador
 25 cm - 10 in



218600
COUTEAU DE CUISINE
chef's knife
 cuchillo de cocina
 25 cm - 10 in



218623
COUTEAU À DÉCOUPER YATAGAN
yatagan carving knife
 cuchillo de trinchar yatagan
 20 cm - 8 in



218609
COUTEAU TRANCELARD
slicing knife
 cuchillo para cortar
 15 cm - 6 in



217868
FOURCHETTE À VIANDE
meat fork
 tenedor de carne
 17 cm - 6 in^{11/16}



218613
COUTEAU TRANCELARD
slicing knife
 cuchillo para cortar
 20 cm - 8 in



218580
COUTEAU À STEAK LAME UNIE
steak knife
 cuchillo de filete hoja lisa
 11 cm - 4 in^{5/16}



218616
COUTEAU TRANCELARD
slicing knife
 cuchillo para cortar
 25 cm - 10 in



218577
COUTEAU À STEAK LAME UNIE
steak knife
 cuchillo de filete hoja lisa
 13 cm - 5 in



218629
COUTEAU SANTOKU
santoku knife granton edge
 cuchillo santoku alveolado
 18 cm - 7 in^{1/16}



218579
COUTEAU À STEAK
steak knife serrated
 cuchillo de filete
 13 cm - 5 in



218611
COUTEAU FILET DE SOLE
filleting knife
 cuchillo para filetar
 15 cm - 6 in



218619
COUTEAU À PAIN
bread knife
 cuchillo de pan
 20 cm - 8 in





218625

218591 - COUTEAU OFFICE

paring knife
cuchillo mondador
10 cm - 4 in



218595 - COUTEAU DE CUISINE

chef's knife
cuchillo de cocina
15 cm - 6 in



218599 - COUTEAU DE CUISINE

chef's knife
cuchillo de cocina
20 cm - 8 in



218602 - COUTEAU DE CUISINE

chef's knife
cuchillo de cocina
25 cm - 10 in



218612 - COUTEAU TRACHELARD

slicing knife
cuchillo para cortar
15 cm - 6 in



218615 - COUTEAU TRACHELARD

slicing knife
cuchillo para cortar
20 cm - 8 in



218617 - COUTEAU TRACHELARD

slicing knife
cuchillo para cortar
25 cm - 10 in



218630 - COUTEAU SANTOKU

santoku knife
granton edge
18 cm - 7 in^{1/16}



218584 - COUTEAU À JAMBON ALVÉOLÉ

ham slicer with granton edge
cuchillo jamonero alveolado
30 cm - 12 in



219350 - COUTEAU À DÉSOSSER

boning knife
cuchillo deshuesador
15 cm - 6 in



217883 - FUSIL

sharpening steel
afilador
20 cm - 8 in



218625 - COUTEAU À DÉCOUPER YATAGAN

yatagan carving knife
cuchillo de trinchar yatagan
20 cm - 8 in



217872 - FOURCHETTE À VIANDE

meat fork
tenedor de carne
17 cm - 6 in^{11/16}



219349 - COUTEAU À STEAK

steak knife
cuchillo de filete
11 cm - 4 in^{5/16}



218622 - COUTEAU À PAIN

bread knife
cuchillo de pan
20 cm - 8 in



218644- COUTEAU OFFICE

paring knife
cuchillo mondador
10 cm - 4 in



218646- COUTEAU DE CUISINE

chef's knife
cuchillo de cocina
15 cm - 6 in



218647 - COUTEAU DE CUISINE

chef's knife
cuchillo de cocina
20 cm - 8 in



218648 - COUTEAU DE CUISINE

chef's knife
cuchillo de cocina
25 cm - 10 in



218649- COUTEAU TRACHELARD

slicing knife
cuchillo para cortar
15 cm - 6 in



218657- COUTEAU TRACHELARD

slicing knife
cuchillo para cortar
25 cm - 10 in



218650- COUTEAU FILET DE SOLE

filleting knife
cuchillo para filetar
15 cm - 6 in



218654- COUTEAU À JAMBON ALVÉOLÉ

ham slicer granton edge
cuchillo jamonero alveolado
23 cm - 9 in^{1/16}



218651- COUTEAU À DÉSOSSER

boning knife
cuchillo deshuesador
13 cm - 5 in



2117881- FUSIL

sharpening steel
afilador
20 cm - 8 in



2117880- FUSIL

sharpening steel
afilador
25 cm - 10 in



218653- COUTEAU À DÉCOUPER YATAGAN

yatagan carving knife
cuchillo de trinchar yatagan
19 cm - 7 in^{1/2}



217868- FOURCHETTE À VIANDE

meat fork
tenedor de carne
17 cm - 6 in^{11/16}



218645- COUTEAU À STEAK

steak knife
cuchillo de filete
12 cm - 4 in^{3/4}



218652- COUTEAU À PAIN

bread knife
cuchillo de pan
20 cm - 8 in



218647



217523 - ECONOME
peeler
pelador
10 cm - 3 in^{15/16}



217687 - COUTEAU OFFICE POINTU
paring knife
cuchillo de cocina con punta
9 cm - 3 in^{15/16}



226270 - COUTEAU OFFICE BEC OISEAU
curved blade paring knife
cuchillo mondador de pico de pájaro
6,5 cm - 2 in^{5/8}



217803 - COUTEAU À DÉSOSSER
boning knife
cuchillo deshuesador
13 cm - 5 in



217804 - COUTEAU À DÉCOUPER
carving knife
cuchillo de trinchar
20 cm - 8 in



217806 - COUTEAU DE CUISINE
chef's knife
cuchillo de cocina
15 cm - 6 in



217808 - COUTEAU DE CUISINE
chef's knife
cuchillo de cocina
20 cm - 8 in



217814 - COUTEAU À PAIN
bread knife
cuchillo de pan
18 cm - 7 in^{1/16}



227765 - COUTEAU TOMATE
tomato knife
cuchillo mondador
9 cm - 3 in^{15/16}



227764 - AIGUISEUR À MOLETTES
toothed wheel knife sharpener
afilador de rueda
9 cm - 3 in^{15/16}



L'ECONOME® BOIS LAQUÉ ANIS
GLOSS FINISH WOOD/GREEN
MADERA LACADA/VERDE

217532 - ECONOME
peeler
pelador
10 cm - 3 in^{15/16}



217538 - FLEXICONOME TOMATE
tomato flexiconome
cuchillo mondador
9 cm - 3 in^{15/16}



217695 - COUTEAU OFFICE POINTU
paring knife
cuchillo de cocina con punta
9 cm - 3 in^{15/16}



217799 - COUTEAU OFFICE BEC OISEAU
curved blade paring knife
cuchillo mondador de pico de pájaro
6,5 cm - 2 in^{5/8}



L'ECONOME® BOIS LAQUÉ AUBERGINE
GLOSS FINISH WOOD/PURPLE
MADERA LACADA/VIOLETA

217528 - ECONOME
peeler
pelador
10 cm - 3 in^{15/16}



217540 - FLEXICONOME JULIENNE
julienne flexiconome
cuchillo mondador
9 cm - 3 in^{15/16}



217691 - COUTEAU OFFICE POINTU
paring knife
cuchillo de cocina con punta
9 cm - 3 in^{15/16}



217795 - COUTEAU OFFICE BEC OISEAU
curved blade paring knife
cuchillo mondador pico de pájaro
6,5 cm - 2 in^{5/8}



L'ECONOME® BOIS LAQUÉ FUCHSIA
GLOSS FINISH WOOD/PINK
MADERA LACADA/ROSA

217533 - ECONOME
peeler
pelador
10 cm - 3 in^{15/16}



217536 - FLEXICONOME UNIVERSEL
utility flexiconome
cuchillo mondador
9 cm - 3 in^{15/16}



217696 - COUTEAU OFFICE POINTU
paring knife
cuchillo de cocina con punta
9 cm - 3 in^{15/16}



217800 - COUTEAU OFFICE BEC OISEAU
curved blade paring knife
cuchillo mondador de pico de pájaro
6,5 cm - 2 in^{5/8}



L'ECONOME® BOIS LAQUÉ MANDARINE
GLOSS FINISH WOOD/ORANGE
MADERA LACADA/NARANJA

217529 - ECONOME
peeler
pelador
10 cm - 3 in^{15/16}



217692 - COUTEAU OFFICE POINTU
paring knife
cuchillo de cocina con punta
9 cm - 3 in^{15/16}



217796 - COUTEAU OFFICE BEC OISEAU
curved blade paring knife
cuchillo mondador pico de pájaro
6,5 cm - 2 in^{5/8}



217695

217808



CASSEROLES - SAUCEPAN - CACEROLA



223972
CASSEROLE
saucepan
cacerola
14 cm - 5 in^{1/2}

223973
CASSEROLE
saucepan
cacerola
16 cm - 6 in^{5/16}

223974
CASSEROLE
saucepan
cacerola
18 cm - 7 in^{1/16}

223975
CASSEROLE
saucepan
cacerola
20 cm - 7 in^{7/8}

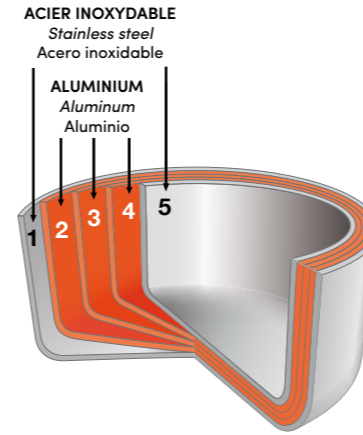

POELES - FRYING PAN - SARTÉN



223977
POËLE
frying pan
sartén
24 cm - 9 in^{7/16}

223979
POËLE
frying pan
sartén
28 cm - 11 in



223980
POËLE
ANTI-ADHÉRENTE
non stick frying pan
sartén antiadherente
24 cm - 9 in^{7/16}

223981
POËLE
ANTI-ADHÉRENTE
non stick frying pan
sartén antiadherente
28 cm - 11 in



223983
SAUTEUSE
ANTI-ADHÉRENTE
non stick saute pan
sartén para saltear
antiadherente
24 cm - 9 in^{7/16}

223984
SAUTEUSE
ANTI-ADHÉRENTE
non stick saute pan
sartén para saltear
antiadherente
28 cm - 11 in

SAUTEUSES - SAUTE PAN - SARTEN PARA SALTEAR

COCOTTE
CASSEROLE DISH
COCOTTE



223986
COCOTTE OVALE AVEC COUVERCLE
oval casserole dish with lid
cocotte ovalada con tapa
24 x 30 cm - 11 in^{13/16} x 10 in^{1/4}

FAITOUT
STEW POT - OLLA



223985
FAITOUT
stewpot
olla
24 cm - 9 in^{7/16}

COUVERCLES - LIDS
TAPAS



223987
14 cm - 5 in^{1/2}

223988
16 cm - 6 in^{5/16}

223989
18 cm - 7 in^{1/16}

223990
20 cm - 7 in^{7/8}

223991
24 cm - 9 in^{7/16}

223992
28 cm - 11 in

CONDUCTION HOMOGENE ET OPTIMALE DE LA CHALEUR DU FOND JUSQU'EN HAUT DES PAROIS POUR UNE PARFAITE MAÎTRISE DE LA TEMPÉRATURE DE CUISSON

CORPS EXTÉRIEUR EN FINITION INOX ET INTÉRIEUR BROSSÉ

GRADUATION INTÉRIEURE DES LITRAGES

PERFORMANCES PROCHES DES QUALITÉS DE CUISSON OBTENUES AVEC DES USTENSILES EN CUIVRE OU EN FONTE

COMPATIBLE TOUS FEUX DONT INDUCTION

Uniform and optimal heat conduction from the base of the pan to the top of the sides for a perfect control of the cooking temperature

Outer body in stainless steel finish and inside in brushed stainless steel

Internal litre scale

The performance is close to cooking qualities usually obtained from cooking with copper or cast iron cookware

Suitable for all hob types including induction

Conducción homogénea y óptima del calor del fondo hasta arriba de las paredes para un perfecto control de la temperatura de cocción

Cuerpo exterior en acabado de acero inoxidable e interior en mate

Graduación interior de los litros

Rendimientos cercanos a las calidades de cocción obtenidas con utensilios de cobre o hierro fundido

Compatible con todo tipo de fuegos, incluidos lo de inducción

NEWCOOK EXPERT



NEWCOOK MODULO

162015 - RAMEQUIN
ramekin
 ramekin
 9,5 cm - 3in^{3/4}



162013 - BOL À CONSOMMÉ
soup bowl
 bol consomé
 10,5 cm - 50 cl - 4in^{1/8} - 16 oz^{15/16}



164275 - TERRINE
terrine with lid
 terrina
 600 g - 8in^{5/8} x 3in^{5/8} x 2in^{5/8}



164276 - TERRINE
terrine with lid
 terrina
 1 kg - 10in^{1/2} x 4in x 2in^{7/8}



162011 - ASSIETTE À CRÈME BRÛLÉE
«crème brûlée» dish
 plato para gratinar
 14 cm - 5 in^{1/2}



164138 - PLAT À ESCARGOT 6 PLACES
snail tray 6 spaces
 bandeja caracoles 6 compartimentos
 16,6 cm - 6 in^{9/16}



NEWCOOK PRECI

168845 - CUILLER À SPAGHETTI
spaghetti serving spoon
 cuchara para espaguetis
 29 cm - 11in^{7/16}



168846 - LOUCHETTE
gravy ladle
 cucharón
 29 cm - 11in^{7/16}



168844 - FOURCHETTE À VIANDE
meat fork
 tenedor de carne
 29 cm - 11in^{7/16}



168843 - CUILLER DE SERVICE
serving spoon
 cuchara de servicio/ensalada
 32 cm - 12in^{5/8}



1

SERVICE DE RÉASSORT
REPLACEMENT PRODUCT SERVICE
SERVICIO DE RENOVACIÓN DE EXISTENCIAS



DEGRENNÉ s'engage à vos côtés en vous offrant la possibilité d'effectuer une commande de réassort pendant les 3 années qui suivent l'arrêt de commercialisation de nos couverts. Ce service s'applique aux collections identifiées dans ce catalogue par ce pictogramme.

Dans le cadre de ce service, vous avez la possibilité de commander les pièces qui vous manquent, une fois par an et selon les conditions définies : contactez nos équipes commerciales pour toute demande.

Le service de réassort est valable pour les pièces suivantes : Fourchette table – Cuiller table – Couteau table (excepté couteaux lourds) Fourchette poisson – Couteau poisson – Fourchette dessert – Cuiller dessert – Couteau dessert (excepté couteaux lourds) – Cuiller café – Cuiller moka.

DEGRENNÉ enables you to order replacement products for a further three years after cutlery is discontinued. This service applies to the collections bearing the logo in the catalogue.

This service enables you to order any items you need once a year and in accordance with the following terms and conditions: please contact our sales teams if you need to order any products.

The replacement products service is available for the following products: table forks, tablespoons, table knives (excluded heavy knives), fish forks, fish knives, dessert forks, dessert spoons, dessert knives (excluding heavy knives), tea spoons and moka spoons.

DEGRENNÉ se compromete a ofrecerle la posibilidad de efectuar un pedido de renovación de existencias durante los 3 años siguientes al final de la comercialización de nuestros cubiertos. Ese servicio se aplica a las colecciones identificadas en este catálogo con el pictograma.

En el marco de ese servicio, tiene la posibilidad de pedir las piezas que le falten, una vez al año y según las condiciones definidas: póngase en contacto con nuestros equipos comerciales para cualquier solicitud.

El servicio de renovación de existencias es válido para las siguientes piezas : Tenedor de mesa – Cuchara de mesa – Cuchillo de mesa (salvo cuchillos pesados) – Tenedor de pescado – Cuchillo de pescado – Tenedor de postre – Cuchara de postre – Cuchillo de postre (salvo cuchillos pesados) – Cucharilla de café – Cucharilla de moka.



SERVICE DE PERSONNALISATION

PERSONNALIZATION SERVICE
SERVICIO DE PERSONNALIZACIÓN

CRÉEZ VOTRE TABLE PERSONNALISÉE GRÂCE AU SAVOIR-FAIRE DEGRENNE

Degrenne rend votre table unique grâce à ses services de personnalisation : couverts, verres, plateaux ou vaisselle, découvrez un large choix de produits et de finitions. Chaque projet de personnalisation est un service sur-mesure qui fait l'objet d'une étude personnalisée par nos commerciaux.

USE DEGRENNE'S EXPERTISE TO CREATE YOUR OWN TABLE

Degrenne's personalization service can make your table unique: explore our wide range of products and finishes, including cutlery, glasses, trays and tableware. Our sales executives deliver a bespoke service for each and every personalisation order.

CREE SU MESA PERSONALIZADA GRACIAS AL SABER HACER DE DEGRENNE

Degrenne hace que su mesa sea única gracias a sus servicios de personalización: cubiertos, copas, bandejas o vajilla, descubra una amplia elección de productos y de acabados. Cada proyecto de personalización es un servicio a medida que es objeto de un estudio personalizado por parte de nuestros comerciales.

VERRES - GLASSWARE - COPAS



Ajoutez votre logo sur le pied du verre
Ajoutez votre logo ou un trait de jauge sur la paraison
(le logo sur la paraison peut également faire office de jauge)



Add your logo to the base of the glass
Add your logo or a measure marking on the bowl
(the logo on the bowl can also be used as the measure marking)



Añada su logotipo en la base de la copa
Añada su logotipo o un indicador de nivel en el cáliz
(el logotipo en el cáliz también puede servir como indicador de nivel)



VAISSELLE - TABLEWARE - VAJILLA



Ajoutez votre logo
Réalisez un décor spécifique
Appliquez un filet de la couleur de votre choix



Add your logo
Add a special pattern
Apply a thin stripe of the colour of your choice



Añada su logotipo
Realice una decoración específica
Aplique un borde de color de su elección



COUVERTS ET PLATERIE - CUTLERY AND HOLLOWARE CUBIERTOS Y PLATERIA

Ajoutez votre logo : en fonction de vos attentes, nous proposons la gravure laser pour une grande précision ou le marquage au poinçon pour une tenue inaltérable dans le temps

Add your logo : In accordance with your requirements, we offer laser engraving if high precision is needed, or alternatively metal stamping for items needing to stand the test of time

Añada su logotipo : en función de sus expectativas, le proponemos el grabado láser para una gran precisión o el marcado con punzón para una resistencia en el tiempo inalterable



1



2



3



4

1 Personnalisez votre finition / Personalize the finish / Personalice su acabado
L'ARGENTURE avec poinçon de maître : Argenture de Classe I (33 microns pour les articles à usage fréquent) ou Argenture qualité hôtelière
SILVER PLATING with a maker's mark: class I silver plating (33 microns for frequently used items) or hotel quality silver-plating
LA PLATEADURA con punzón de maestro: Plateadura de clase I (33 micrones para los artículos de uso frecuente) o Plateadura de calidad hotelera

2 LA DORURE : Dorure à l'or fin des couverts ou de certaines parties des couverts
GILDING : Cutlery or alternatively some sections of cutlery can be gilded with fine gold
LA DORADURA : Doradura con oro fino de los cubiertos o de algunas partes de los cubiertos

3 LA FINITION BROSSÉE OU SATINÉE : Polissage spécifique des couverts ou des accessoires de platerie pour un rendu mat
BRUSHED OR SATIN FINISH: Specially polished cutlery and holloware accessories for a matt finish
EL ACABADO MATE O SATINADO : Pulido específico de los cubiertos o de los accesorios de platería para un acabado mate

4 LA FINITION ÉTAÏN : Polissage spécifique des couverts pour un effet vieilli façon étain
PEWTER FINISH: Specially polished cutlery for a pewter-style antique effect
EL ACABADO DE ESTAÑO : Pulido específico de los cubiertos para un efecto envejecido tipo estaño

NOTES

A series of horizontal dotted lines for writing notes on page 212.

NOTES

A series of horizontal dotted lines for writing notes on page 213.



NOTES

A series of horizontal dotted lines for writing notes, spanning the width of the page.



NOTES

A series of horizontal dotted lines for writing notes, spanning the width of the page.

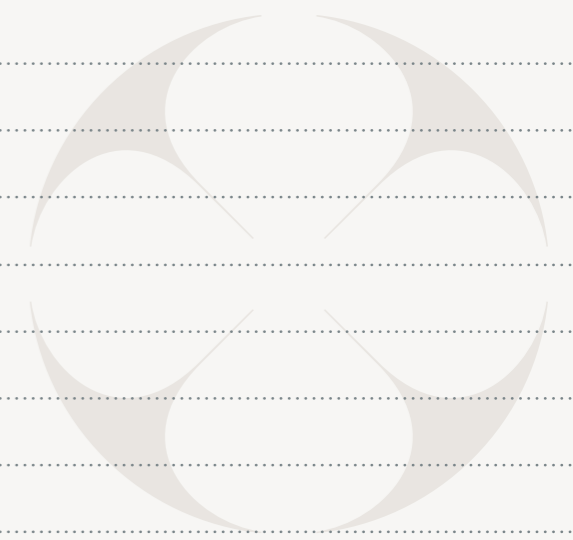



Descente Internationale
International range
Gama internacional



Sélection Degrenne:
Produits emblématiques de la
marque disponibles rapidement pour
vos commandes prioritaires

Degrenne's selection :
The brand's flagship
products made available quickly for
your priority product orders

Selección Degrenne : Productos
emblemáticos de la marca disponibles
rápidamente para sus pedidos
prioritarios



Garantie micro-ondes
Microwave safe
Garantía microondas



Garantie lave-vaisselle
Dishwasher safe
Garantía lavavajillas



Garantie congélateur
Freezer safe
Garantía congelador



Garantie four
Oven safe
Garantía horno



Finition métal argenté - Argenture Classe 1-
33 microns(pour les articles à usage fréquent)
Silver plated finish - Class 1 silverplating - 33 microns
Acabado plateado - tipo Clase1 - 33 micras



Argenture qualité hôtelière
Silver plated hotel quality
Acabado hotel quality



Finition miroir
Mirror finish
Acabado brillo



Finition satinée
Satin finish
Acabado cepillado



Finition Vintage
Vintage Finish
Acabado Vintage



Forgé
Forged
Forjado

18%

18-10

Acier inoxydable
Stainless steel
Acero inoxidable



Epaisseur fourchette de table
Thickness table fork
Espesor tenedor mesa



Réassort
Replacement
Renovación



Revêtement PVD
PVD coating
Revestimiento PVD



Verre
Glass
Cristal



SHQ/ Sodocalcique Haute Qualité
High Quality soda - lime
sodocàlcico alta calidad



Cristallin Haute Qualité
HQ low lead crystal
Cristalino alta calidad



Verre soufflé bouche teinté dans la masse
Hand-blown integrally dyed glass
Vaso soplado a boca, pintado en masa



1000 cycles garantis minimum
1000 wash cycles guaranteed
1000 ciclos de lavado garantizados



Porcelaine
Porcelain
Porcelana



Porcelaine de Limoges
Limoges porcelain
Porcelana de Limoges



Aimanté
With magnet
Con imán



Gres
Stoneware
Arenisca

MARQUES DEPOSEES/COPYRIGHTS



L'ECONOME®

LE LAGUIOLE DE
DEGRENNE
PARIS

FRANCE USA

SIEGE SOCIAL / HEAD OFFICE / SEDE SOCIAL
Service clients - Customer services - Atención al cliente

rue Guy Degrenne - BP 50056
14502 Vire cedex
FRANCE
tel : +33 (0)2 31 66 44 15

OTHER COUNTRIES / OTROS PAÍSES
tel : +33 (0)2 31 66 44 92

infohotel@degrenne.fr

FILIALE USA - US SUBSIDIARY

DNA/Degrenne North America inc.
390 George Street - Suite 404 - New Brunswick
NJ 08901 USA

tel : 732 565 0820
fax : 732 565 0828

csrv.dna@degrenneparis.com
www.degrenneparis.us

DIRECTION GÉNÉRALE - GENERAL MANAGEMENT - DIRECCIÓN GENERAL
Direction Marketing - Marketing division - Dirección de Marketing
Direction Commerciale - Sales division - Dirección Comercial

89 rue La Boétie
75008 PARIS
FRANCE

SHOWROOMS (sur rendez-vous)

PARIS (89 rue La Boétie - 75008 PARIS)
NEW YORK (41 Madison)

FRANCE
infohotel@degrenne.fr
Tel : +33 (0)2 31 66 44 15

OTHER COUNTRIES/OTROS PAISES
infohotel@degrenne.fr
Tel : +33 (0)2 31 66 44 92

FILIALE USA/US SUBSIDIARY
csrv.dna@degrenneparis.com
Tel : 732 565 0820



Degrenne



Degrenne_Paris

www.degrenneparis.com