



# DEGRENE

P A R I S

Since 1948  
70 years of Excellence



**2019**

---

FAIRE NAÎTRE  
LES PLUS BELLES  
ÉMOTIONS

---



DEGRENNE

P A R I S

Les collections DEGRENNE habillent les plus belles tables et célèbrent **le renouveau de la Gastronomie Française**. Plébiscitées par de **nombreux grands Chefs** à travers le monde, nous souhaitons contribuer à votre talent du goût avec **exigence et pragmatisme**. Nous créons pour vous de véritables outils de dégustation au service de votre passion, de votre métier. **Gastronomie, bistronomie, brasserie**, quelque soit votre cuisine, la Maison DEGRENNE vous propose des **solutions adaptées à votre univers**, à votre inspiration pour faire naître auprès de votre clientèle, les plus belles émotions.

---

#### CREATING THE MOST BEAUTIFUL EMOTIONS

---

The DEGRENNE collections decorate the most beautiful tables and celebrate **the revival of French Gastronomy**. We have been chosen by **numerous great Chefs** worldwide and we now wish to enhance your talent for flavour with our high level of **quality and expediency**. We have created true tools to savour food and service your passion and profession. Whatever your cuisine, whether you work in **haute cuisine, a bistro or brasserie**, the Maison DEGRENNE will provide you with **solutions that are right for your environment** and inspiration so you can generate the most beautiful emotions within your customers.

---

#### DESPERTAR LAS MÁS BELLAS EMOCIONES

---

Las colecciones de DEGRENNE visten las mesas más hermosas y celebran **la renovación de la gastronomía francesa**. Respaldados por **numerosos chefs de renombre** de todo el mundo, deseamos contribuir a sus creaciones culinarias con **exigencia y pragmatismo**. Creamos para usted verdaderas herramientas de degustación al servicio de su pasión y su oficio. Del segmento alto al más accesible... Con independencia de su oferta, la firma DEGRENNE le ofrece **soluciones adaptadas a su universo** e inspiración para despertar en sus clientes las más bellas emociones.









## NOTRE PASSION : VOUS INSPIRER



Entreprise  
du Patrimoine  
Vivant  
L'excellence  
des savoir-faire  
français

Avec vous, nous désirons partager une véritable **culture de l'art de vivre**. Quelque soit votre approche élégante, innovante, sobre ou luxuriante, la Maison DEGRENNE dessine pour vous les collections qui sauront conter votre cuisine : **courbes, matières, couleurs, chaque détail compte** pour souligner votre travail. Tout comme le vôtre, notre métier exige de **la rigueur et le sens du détail**. Nous avons la passion du «beau» pour vous inspirer le meilleur. Cette passion est initiée dès sa fondation, il y a 70 ans, par **Guy Degrenne**. Aujourd'hui, la Maison DEGRENNE arbore avec fierté le label **Entreprise du Patrimoine Vivant**, qui consacre l'excellence artisanale et industrielle française.

### OUR PASSION: INSPIRING YOU

We wish to share a genuine **lifestyle culture** with you. Whatever your approach, whether elegant, innovative or luxurious, the Maison DEGRENNE will design collections for you, which will tell the story of your cuisine: **curves, materials, colours... every detail will enhance** your work. Just like you, our profession requires us to have **a strong work ethic and be detail-orientated**. We have a passion for the "beautiful" to inspire your best work. This passion was first generated, 70 years ago, by **Guy Degrenne**, when he created the company. Today, the Maison DEGRENNE proudly bears the "**Entreprise du Patrimoine Vivant**" (living heritage company) label, a testament of French artisanal and industrial excellence.

### NUESTRA PASIÓN: INSPIRARLE

Deseamos compartir con usted una auténtica **cultura del disfrute de la vida**. Con independencia de que su oferta sea elegante, innovadora, sobria o lujosa, la firma DEGRENNE diseña colecciones a imagen y semejanza de su cocina: **curvas, materiales, colores... cada detalle cuenta** para realzar sus creaciones. Nuestra profesión, como la suya, **exige rigor y atención al detalle**. Nos apasiona lo bello para inspirarle mejor. Esta pasión se inició desde la fundación de la firma, hace setenta años, por **Guy Degrenne**. En la actualidad, la firma DEGRENNE exhibe con orgullo su certificación de **Entreprise du Patrimoine Vivant** (empresa del patrimonio vivo), que reconoce la excelencia artesanal e industrial francesa.





## FIER DE NOS ARTISANS!

À Vire comme à Limoges, c'est l'excellence d'hommes et de femmes passionnés par leur métier, qui perpétuent **des savoir-faire transmis de génération en génération** et sont toujours prêts à **relever de nouveaux défis**. Chaque artisan contribue à notre histoire, chaque parcours témoigne de **la richesse de nos compétences**. Le souci de **la qualité, la rigueur technique et l'art du geste bien accompli** sont les critères d'exigences communs à tous.

### PROUD OF OUR ARTISANS!

Both in Vire and Limoges, men and women who are passionate about their profession perpetuate the  **savoir-faire that has been transmitted from generation to generation** and are always ready to **take on new challenges**. Each artisan contributes to our story and every pathway bears witness to **the wealth of our abilities**. We require each artisan to be devoted to **high quality, rigorous technique and the art of doing things comme il faut**.

### ¡ORGULLOSOS DE NUESTROS ARTESANOS!

Tanto en Vire como en Limoges, unos trabajadores apasionados por su oficio perpetúan **las tradiciones transmitidas de generación en generación**, siempre dispuestos a **superar nuevos desafíos**. Cada artesano contribuye a nuestra historia; cada recorrido da fe de **la riqueza de nuestras competencias**. La atención a la **calidad, el rigor técnico y el saber hacer** son nuestros criterios y exigencias comunes.







7,5

MILLIONS DE PIÈCES PRODUITES CHAQUE ANNÉE

MILLION PIECES PRODUCED EACH YEAR

MILLONES DE PIEZAS PRODUCIDAS CADA AÑO

1300

RÉFÉRENCES CHR

HORECA REFERENCES  
REFERENCIAS CHR

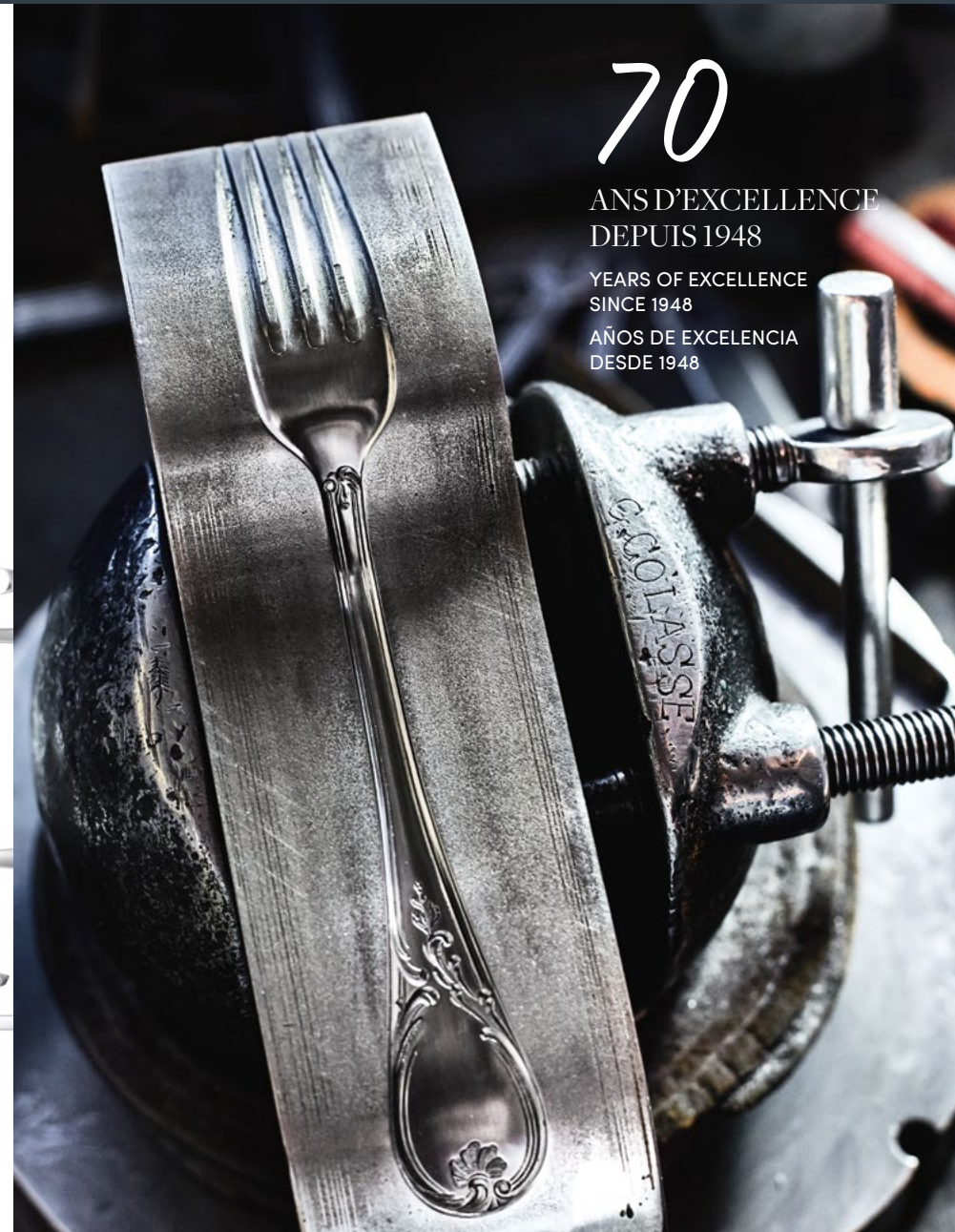

70

ANS D'EXCELLENCE DEPUIS 1948

YEARS OF EXCELLENCE SINCE 1948  
AÑOS DE EXCELENCIA DESDE 1948

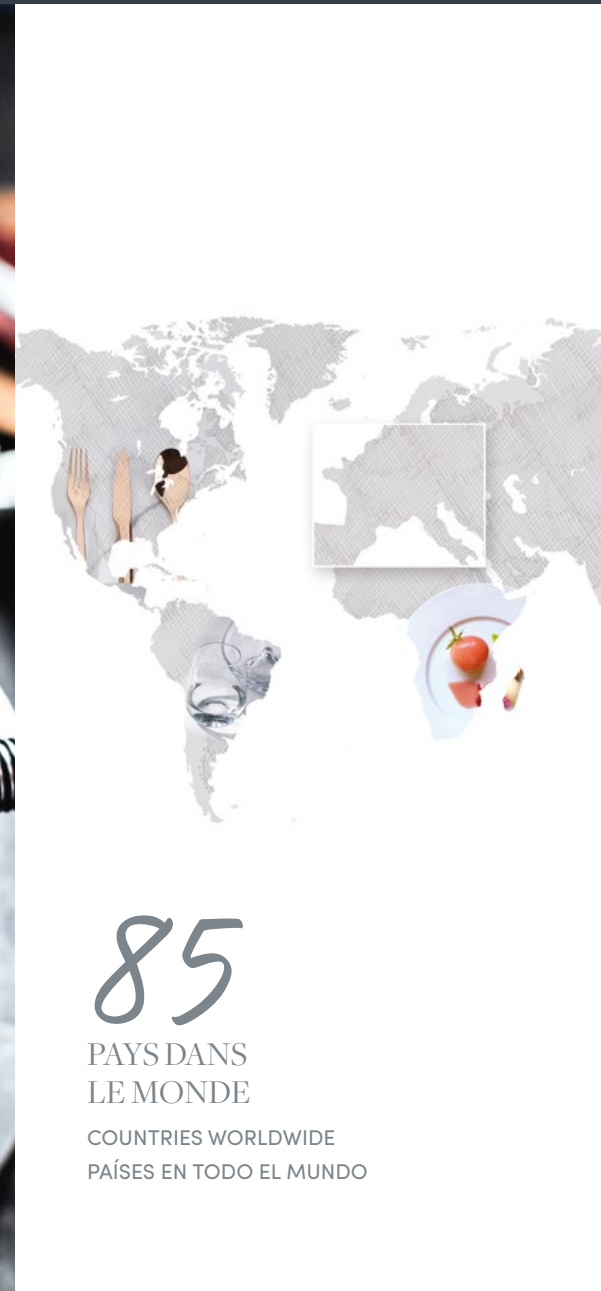

85

PAYS DANS LE MONDE

COUNTRIES WORLDWIDE  
PAÍSES EN TODO EL MUNDO



750

COLLABORATEURS

PARTNERS  
EMPLEADOS



3

USINES

FACTORIES  
FÁBRICAS





## ILS NOUS FONT CONFIANCE

THEY TRUST US

NOS DEPOSITAN SU CONFIANZA

LE FOUQUETS  
SOCIÉTÉ DES BAINS DE MER  
LUTETIA  
WALDORF ASTORIA  
PENINSULA  
PLAZA  
ELEVEN MADISON PARK  
BELLAGIO  
MARRIOTT / STARWOOD / SHERATON  
FOUR SEASONS  
HILTON WORLDWIDE  
ACCOR HOTELS  
PULLMAN  
SOÏTEL / BARRIÈRE  
M GALLERY / MAMA SHELTER  
NOVOTEL  
MERCURE  
IBIS  
INTERCONTINENTAL  
RITZ CARLTON  
LOUVRE HOTELS  
GOLDEN TULIP  
CAMPANILE  
KYRIAD  
FAIRMONT / RAFFLES HOTELS  
SWISSOTEL  
W HOTELS



## PARTENAIRES DE L'EXCELLENCE

PARTNERS IN EXCELLENCE

SOCIOS DE LA EXCELENCIA

LES CUISINIERS DE LA RÉPUBLIQUE  
LES MAÎTRES CUISINIERS DE FRANCE  
ACADÉMIE CULINAIRE DE FRANCE  
CLUB DES DIRECTEURS DE LA RESTAURATION  
ET DE L'EXPLOITATION  
LES TOQUES BLANCHES LYONNAISES  
COUPE GEORGES BAPTISTE  
FERRANDI  
L'ÉCOLE FRANÇAISE DE GASTRONOMIE  
INSTITUT PAUL BOCUSE  
ÉCOLE DE MANAGEMENT L'HOTELLERIE  
RESTAURATION  
GLION - SUISSE  
INSTITUTE OF HIGHER EDUCATION  
BEST  
ÉCOLE DE BORDEAUX  
AFLYHT  
ASSOCIATION FRANÇAISE DES LYCÉES  
D'HOTELLERIE ET DE TOURISME  
LES TOQUES NORMANDES  
ARYZTA FOOD SOLUTIONS  
EURO TOQUES - SUISSE



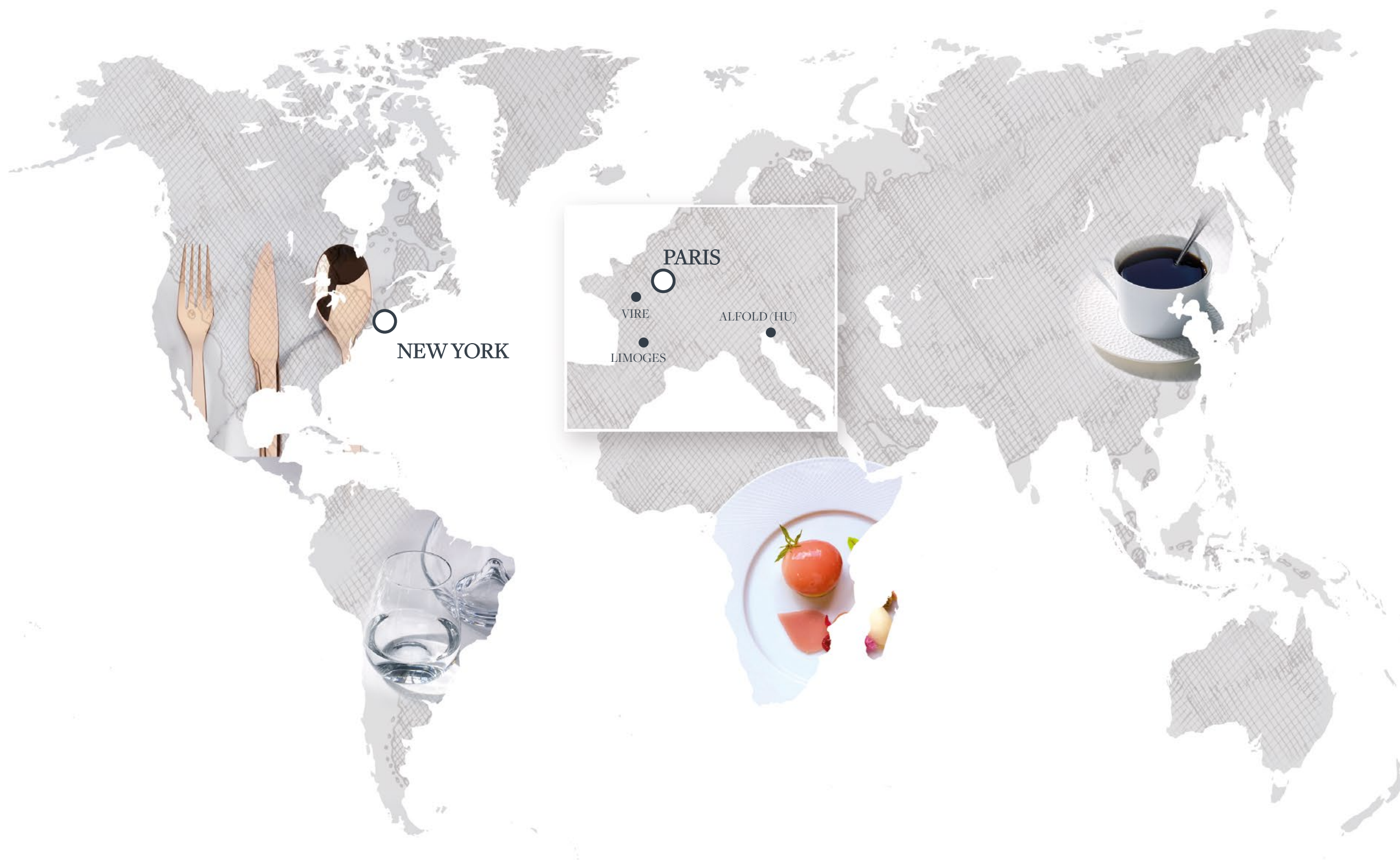

# 2

## SHOWROOMS



### PARIS

**NEW YORK**  
41 MADISON

# 3

## SITES DE PRODUCTION

PRODUCTION SITES  
PLANTAS DE PRODUCCIÓN

### VIRE / FRANCE

COUVERTS ET PLATERIE  
FLATWARE AND HOLLOWWARE  
CUBIERTOS E ORFEBRERÍA

### LIMOGES / FRANCE

VAISSELLE  
TABLEWARE  
VAJILLA

### ALFOLD / HONGRIE

VAISSELLE  
TABLEWARE  
VAJILLA







**GASTRO  
NOMIE**  
HAUTE CUISINE  
SEGMENTO ALTO



**BISTRO  
NOMIE**  
BISTROS  
SEGMENTO MEDIO



**BRASS  
ERIE**  
BRASSERIES  
SEGMENTO BAJO



**BAN  
QUET**  
BANQUETS  
BANQUETES

## AU CŒUR DES TENDANCES

Voici **4 tendances** pour cette saison 2018-19 pour donner libre cours à vos idées. La Maison DEGRENNE anime ces courants gastronomiques **classiques ou novateurs** avec une **large gamme de produits à associer, mixer** entre eux pour obtenir des contrastes parfois simples, parfois étonnants, habillés de matières ou simplement lumineux.

### AT THE HEART OF TRENDS

Here are **4 trends** for the 2018-19 season so you can give your ideas free rein. The Maison DEGRENNE facilitates these **classic or innovative** gastronomical trends through **a large range of products that can be mixed and matched** to obtain contrasts, which can be either simple or astonishing and are either adorned with materials or shine alone.

### AL RITMO DE LAS TENDENCIAS

Presentamos **cuatro tendencias** de esta temporada 2018-19 para dar rienda suelta a su imaginación. La firma DEGRENNE complementa los estilos gastronómicos **clásicos o innovadores** con **una amplia gama** de productos **que pueden combinarse y mezclarse** para crear contrastes en ocasiones sencillos y, en otras, sorprendentes, con distintas texturas o simplemente luminosos.





# L'ART DES METS

THE ART OF DISHES  
EL ARTE DE LA GASTRONOMÍA

La brillante de nos porcelaines, le raffinement de nos textures sont une invitation à l'élégance : l'art du bon exige l'art du beau.

Our brilliant porcelain and refined textures invite elegance to the table: the art of the good is nothing without the art of the beautiful.

El brillo de nuestras porcelanas y el refinamiento de nuestras texturas invitan a la elegancia: para el arte de lo bueno, es imprescindible el arte de lo bello.



A



B

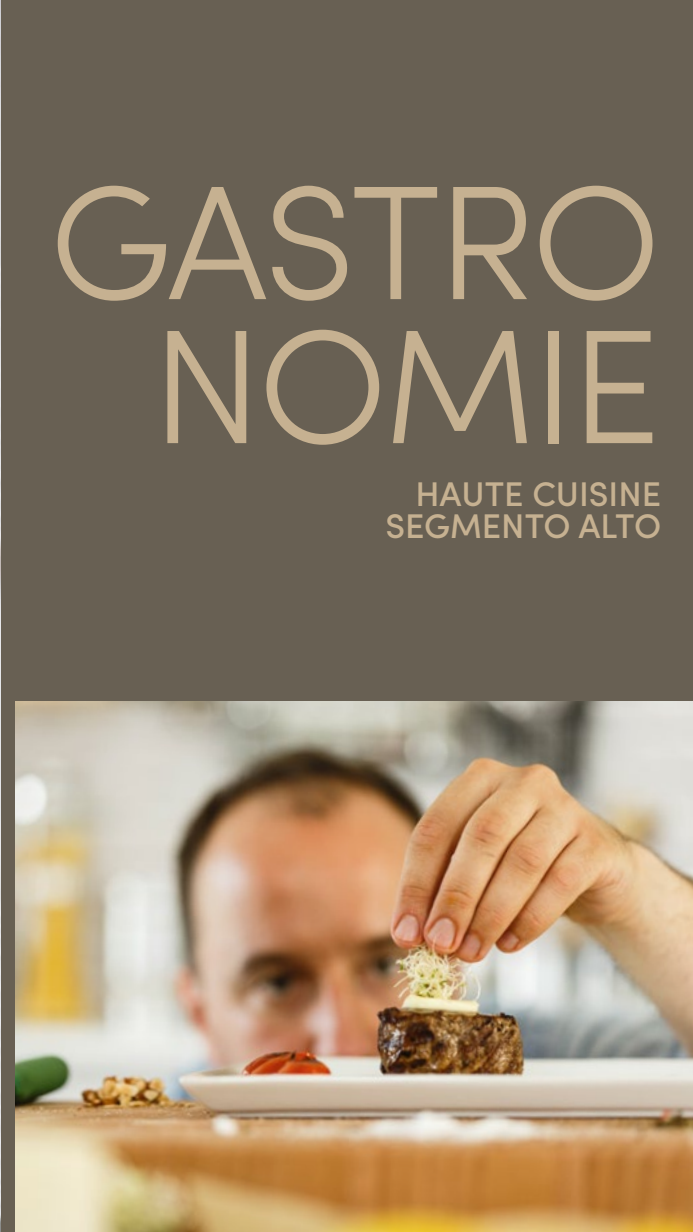

# GASTRO NOMIE

HAUTE CUISINE  
SEGMENTO ALTO



D

**HIGH QUALITY** **FRENCH-STYLE CHIC**

*Raffiné* **EXIGENCIA**

**REFINED** *Chic à la française*

REFINADO

*Exigence* **SOFISTICACIÓN FRANCESA**



C



- A **BORÉAL SATIN**  
193324 - ASSIETTE GOURMET P.40  
SHALLOW BOWL - PLATO GOURMET
- B, D **L FRAGMENT**  
227844 - ASSIETTE PLATE P.30  
ROUND DINNER PLATE - PLATO REDONDO
- C **BAHIA**  
230944 - COCOTTE P.50  
ROUND CASSEROLE - COCOTTE/BOL



# TRADITION REVISITÉE

REVISITED TRADITION  
LA TRADICIÓN ACTUALIZADA

Mixez nos lignes « classiques », nos matières contemporaines. Surprenez avec élégance et créativité.

Mix our "classic" lines and contemporary materials. Create surprising effects with elegance and creativity.

Combine nuestras líneas clásicas y nuestros materiales contemporáneos. Sorprenda con elegancia y creatividad.



# BISTRO NOMIE

BISTROS  
SEGMENTO MEDIO

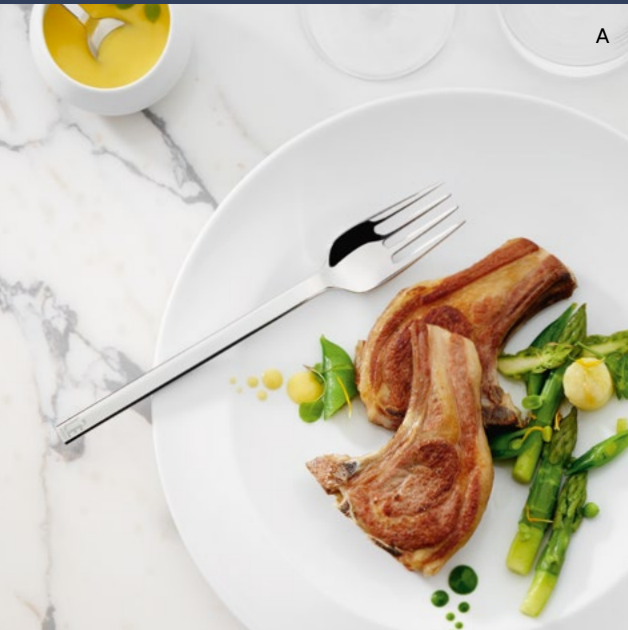

A



C



B



E

## CREATIVITY

*Cosmopolite*

## COSMOPOLITAN

CREATIVIDAD

*Revisitée*

ACTUALIZADO

*Créativité*

## REVISITED

COSMOPOLITA

- A L'E STARCK**  
233011 - FOURCHETTE DE TABLE  
TABLE FORK - TENEDOR DE MESA P.92
- B BAHIA**  
230970, 230942, 230956 - MINI BOL  
SMALL BOWL - MINI BOL P.50
- C BORÉAL**  
207134 - ASSIETTE PLATE OVALE  
OVAL DINNER PLATE - PLATO OVAL P.36
- 207136 - ASSIETTE CALOTTE  
SHALLOW BOWL - COUPE PLAT HONDO P.36
- D BAHIA**  
230965 - ASSIETTE PLATE - ROUND DINNER  
PLATE - PLATO REDONDO P.48
- E MODULO NATURE**  
194454 - ASSIETTE PLATE - DINNER  
PLATE/COUPE - PLATO REDONDO P.52



# PATRIMOINE CULINAIRE

CULINARY HERITAGE  
PATRIMONIO CULINARIO

Générosité et authenticité constituent l'esprit de la Brasserie. L'épure et la praticité de nos produits mettent en valeur avec simplicité un plat du jour, un tartare, un expresso...

Generosity and authenticity are at the heart of the Brasserie. The lines and practicality of our products highlight the special of the day, a tartare or an espresso in the simplest manner...

La generosidad y la autenticidad constituyen el espíritu del segmento más accesible. La sobriedad y la practicidad de nuestros productos ponen de relieve con sencillez el plato del día, un tartar o un expreso...



# BRASSERIE

BRASSERIES  
SEGMENTO BAJO



- A SMOOS**  
207766 - TASSE À EXPRESSO - EXPRESSO CUP - EXPRESSO TAZA P.62  
161025 - SOUCOUBE - ESPRESSO SAUCER - ESPRESSO PLATO P.62
- B ECLIPSE**  
234609 - ASSIETTE CREUSE CALOTTE - ROUND CEREAL PLATE - PLATO HONDO P.70
- C ECLIPSE**  
234604 - BOL À SALADE - SALAD BOWL - BOL DE ENSALADA P.70

A

URBANO

*Citadin*

URBAN

**AUTHENTIC**

GENEROSIDAD

*Générosité*

AUTÉNTICO

**GENEROSITY**

*Authentique*



B



C



# L'ART DE LA RÉCEPTION

THE ART OF THE RECEPTION  
EL ARTE DE LAS RECEPCIONES

Notre gamme de buffet EVENTO nos assiettes, nos verres et nos couverts s'offrent à la lumière de la journée ou d'une soirée pour célébrer votre art du moment.

Our EVENTO buffet range, our plates, our glasses and our cutlery allow you to celebrate your art of the moment by day or by night.

Nuestra gama de bufé EVENTO, nuestros platos, nuestras copas y nuestros cubiertos se muestran a la luz de un día o una noche de celebración.



# BANQUET

BANQUETS  
BANQUETES



FESTIVO  
FESTIVE  
*Festif*  
EVENT  
ELEGANTE  
*Evénement*  
EVENTO  
ELEGANT



- A ANYTIME**  
184567 - FLUTE À CHAMPAGNE - CHAMPAGNE FLUTE P.188  
FLAUTA CHAMPÁN
- NEWPORT**  
184180 - SEAU À CHAMPAGNE 2 BOUTEILLES - CHAMPAGNE BUCKET P.166  
CHAMPAGNE BUCKET 2 BOTTLES - CHAMPANERA
- B NEWPORT CUBIQUE**  
211886 - PLATEAU RECTANGULAIRE - RECTANGULAR SERVING P.160  
TRAY - BANDEJA RECTANGULAR
- C EVENTO**  
216143 - CHAFING DISH MIROIR - CHAFING DISH MIRROR FINISH P.200  
MODULO DE ACERO ACABADO BRILLO  
235361 - MODULE FROID BROSSÉ - REFRIGERATED SET STAINLESS P.202  
STEEL BRUSHED - MODULO DE ACERO ACABADO SATINADO
- D EVENTO**  
231303 - URNE À JUS DE FRUITS BROSSÉE - BRUSHED JUICE P.206  
DISPENSER - DISPENSADOR DE ZUMO ACABADO SATINADO





## VAISSELLE

DEGRENNÉ travaille les formes et les matières en portant une attention particulière aux **attentes des chefs**, tant esthétiques que dans l'usage. Pour faire de la table un moment dédié aux **plaisirs gastronomiques**, du plus simple au plus élaboré, DEGRENNÉ imagine **des collections uniques qui incarnent l'excellence et qui peuvent être associées entre elles**. En jouant sur les combinaisons, les contrastes, les formes, les couleurs et les matières, chaque mets trouve harmonieusement sa place à table, avec **élégance et sobriété**. **Matières nobles, lignes épurées**, épousez tous les savoir-faire DEGRENNÉ lorsque vous dressez votre table.

### TABLEWARE

DEGRENNÉ develops shapes and materials, while paying careful attention to **chefs' practical usage** and aesthetic requirements. DEGRENNÉ designs **unique collections that are the very embodiment of excellence and can also be combined**, in order to make dining a moment of **culinary pleasure**, from the simplest to the most elaborate pleasures. Each dish harmoniously finds its rightful place on the table, with **simplicity and elegance**, thanks to the combinations, contrasts, shapes, colours and materials employed by DEGRENNÉ. Capitalize on DEGRENNÉ's extensive expertise when setting your table : we offer **sleek lines and the finest materials**.

### VAJILLA

DEGRENNÉ trabaja las formas y los materiales prestando una atención particular a las **expectativas de los chefs**, tanto estéticas como de uso. Para convertir la mesa en un momento dedicado a los **placeres gastronómicos**, del más sencillo al más elaborado, DEGRENNÉ imagina **coleccionaciones únicas que encarnan la excelencia y que pueden combinarse entre sí**. Jugando con las combinaciones, los contrastes, las formas, los colores y los materiales, cada plato encuentra su lugar en la mesa con armonía, **elegancia y sobriedad**. **Materiales nobles, líneas depuradas**, elija todos los saber hacer de DEGRENNÉ a la hora de preparar su mesa.

**L FRAGMENT**  
227847 - ASSIETTE GOURMET  
DESSERT/SALAD/APP.PLATE W/WIDE RIM - PLATO REDONDO

P.30

**BAHIA**  
230910 - COCOTTE - ROUND CASSEROLE  
COCOTTE BOL

P.50







MADE IN FRANCE

---

## PORCELAINE DE LIMOGES ET EXCELLENCE

---

Allez élégance et sobriété grâce à des matières nobles et des formes aux lignes épurées. D'une blancheur et d'une opalescence remarquables, la Porcelaine de Limoges est symbole d'excellence et de pureté.

---

### LIMOGES PORCELAIN AND EXCELLENCE

---

Combine elegance and simplicity by harnessing the finest materials and sleek lines. **Stunning white and milky iridescent Limoges porcelain is the epitome of excellence and purity.**

---

### PORCELANA DE LIMOGES Y EXCELENCIA

---

Conjuga elegancia y sobriedad gracias a materiales nobles y formas con líneas depuradas. **De una blancura y una opalescencia destacables, la porcelana de Limoges es símbolo de excelencia y de pureza.**





L

227822  
**ASSIETTE DE PRÉSENTATION**  
ROUND PRESENTATION PLATE  
W/WIDE RIM  
PLATO REDONDO  
32 CM - 12 IN<sup>5/8</sup>

L

227823  
**ASSIETTE PLATE**  
ROUND DINNER PLATE  
W/WIDE RIM  
PLATO REDONDO  
28 CM - 11 IN

L

227824  
**ASSIETTE DESSERT**  
ROUND DESSERT/SALAD/APP.PLATE  
W/WIDE RIM  
PLATO REDONDO  
24 CM - 9 IN<sup>7/16</sup>

L

232576  
**ASSIETTE CREUSE CALOTTE**  
ROUND CEREAL PLATE  
PLATO HONDO  
18,5 CM - 7 IN<sup>5/16</sup>

L

227825  
**ASSIETTE À PAIN**  
ROUND BREAD & BUTTER PLATE  
W/WIDE RIM  
PLATO REDONDO  
14 CM - 5 IN<sup>1/2</sup>

206504  
**BOUCHON PORCELAINE  
POUR CLOCHE VERRE**  
PORCELAIN LID FOR GLASS DOME COVER  
TAPA DE PORCELANA PARA  
CAMPANA DE VIDRIO  
5,2 CM - 2 IN<sup>1/16</sup>

COMPATIBLE AVEC LES GRANDES ASSIETTES COCOTTE GOURMET P.44  
COMPATIBLE WITH LARGE CASSEROLE PLATES GOURMET P.44  
COMPATIBLE CON GRANDES COCOTTE PLATOS GOURMET P.44



L

227826  
**ASSIETTE GOURMET**  
ROUND SHALLOW BOWL W/WIDE RIM  
PLATO GOURMET  
30 CM - 11 IN<sup>3/16</sup>

209384



209383  
**BLANC BRILLANT**  
BRIGHT WHITE  
BLANCO BRILLANTE

209384



209720  
**BLANC SABLÉ**  
SANDY WHITE  
BLANCO PURO

230820



230821  
**BLEU**  
BLUE  
AZUL

204042



204041  
**CARBONE**  
GREY  
GRIS

AUTRES COULEURS  
OTHER COLORS  
OTROS COLORES



BAHIA P.50



204043  
**CLOCHE VERRE BOROSILICATE**  
GLASS DOME COVER  
CAMPANA VIDRIO BOROSILICATO  
17X9 CM - 6 IN<sup>11/16</sup> X 3 IN<sup>9/16</sup>

COMPATIBLE AVEC LES COCOTTES GOURMET & BAHIA  
COMPATIBLE WITH GOURMET & BAHIA ROUND CASSEROLES  
COMPATIBLE CON GOURMET & BAHIA COCOTTE BOLES



L

227827  
**ASSIETTE GOURMET**  
ROUND SHALLOW BOWL W/WIDE RIM  
PLATO GOURMET  
28 CM - 11 IN



186849  
**BLANC BRILLANT**  
BRIGHT WHITE  
BLANCO BRILLANTE



211893  
**BLANC SABLÉ**  
SANDY WHITE  
BLANCO PURO



230822  
**BLEU**  
BLUE  
AZUL



234209  
**CARBONE**  
CARBONE/BLACK  
NEGRO

AUTRES COULEURS  
OTHER COLORS  
OTROS COLORES



BAHIA P.50



182614  
**CLOCHE INOX**  
DOME COVER, STAINLESS STEEL  
CAMPANA  
24 CM - Ø 9 IN<sup>7/16</sup>

COMPATIBLE AVEC LES BOLS GOURMET & BAHIA  
COMPATIBLE WITH GOURMET & BAHIA BOWLS  
COMPATIBLE CON BOLES GOURMET & BAHIA



L

227828  
**TASSE ESPRESSO**  
DEMITASSE CUP  
ESPRESSO TAZA  
10 CL - 3 OZ<sup>2/8</sup>



L

227831  
**SOUCOUPE ESPRESSO**  
DEMITASSE SAUCER  
ESPRESSO PLATO  
12,5 CM - 4 IN<sup>3/4</sup>



L

227829  
**TASSE LUNGO**  
COFFEE/TEA CUP  
LUNGO TAZA  
25 CL - 8 OZ<sup>7/16</sup>



L

227832  
**SOUCOUPE LUNGO**  
COFFEE/TEA SAUCER  
LUNGO PLATO  
15,8 CM - 6 IN<sup>1/4</sup>



CÉRAMIQUE TEINTÉE MASSE  
MASS COLORED CERAMIC  
CERÁMICA COLORADO A TODA MESA



182301  
**CLOCHE INOX**  
DOME COVER, STAINLESS STEEL  
CAMPANA  
14,8 CM - Ø 5 IN<sup>13/16</sup>





# COLLECTION L FRAGMENT

MADE IN FRANCE



L

227843  
**ASSIETTE DE PRÉSENTATION**  
ROUND PRESENTATION PLATE  
W/WIDE RIM  
PLATO REDONDO  
32 CM - 12 IN<sup>5/8</sup>



L

227844  
**ASSIETTE PLATE**  
ROUND DINNER PLATE  
W/WIDE RIM  
PLATO REDONDO  
28 CM - 11 IN

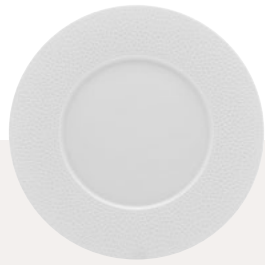

L

227845  
**ASSIETTE DESSERT**  
ROUND DESSERT/SALAD/APP.PLATE  
W/WIDE RIM  
PLATO REDONDO  
24 CM - 9 IN<sup>7/16</sup>



L

227846  
**ASSIETTE À PAIN**  
ROUND BREAD & BUTTER PLATE/WIDE  
RIM  
PLATO REDONDO  
14 CM - 5 IN<sup>1/2</sup>

206504  
**BOUCHON PORCELAINE  
POUR CLOCHE VERRE**  
PORCELAIN LID FOR GLASS DOME COVER  
TAPA DE PORCELANA PARA  
CAMPANA DE VIDRIO  
5,2 CM - 2 IN<sup>17/16</sup>



L

227847  
**ASSIETTE GOURMET**  
ROUND SHALLOW BOWL W/WIDE RIM  
PLATO GOURMET  
30 CM - 11 IN<sup>3/16</sup>

209384



209383  
**BLANC BRILLANT**  
BRIGHT WHITE  
BLANCO BRILLANTE

209384



209720  
**BLANC SABLÉ**  
SANDY WHITE  
BLANCO PURO

230820



230821  
**BLEU**  
BLUE  
AZUL

204042



204041  
**CARBONE**  
GREY  
GRIS

AUTRES COULEURS  
OTHER COLORS  
OTROS COLORES



BAHIA P.50



204043  
**CLOCHE VERRE BOROSILICATE**  
GLASS DOME COVER  
CAMPANA VIDRIO BOROSILICATO  
17X9 CM - 6 IN<sup>11/16</sup> X 3 IN<sup>9/16</sup>



L

227848  
**ASSIETTE GOURMET**  
ROUND SHALLOW BOWL W/WIDE RIM  
PLATO GOURMET  
28 CM - 11 IN



186849  
**BLANC BRILLANT**  
BRIGHT WHITE  
BLANCO BRILLANTE



211893  
**BLANC SABLÉ**  
SANDY WHITE  
BLANCO PURO



230822  
**BLEU**  
BLUE  
AZUL



234209  
**CARBONE**  
CARBONE/BLACK  
NEGRO

AUTRES COULEURS  
OTHER COLORS  
OTROS COLORES



BAHIA P.50



182614  
**CLOCHE INOX**  
DOME COVER, STAINLESS STEEL  
CAMPANA  
24 CM - Ø 9 IN<sup>7/16</sup>

COMPATIBLE AVEC LES BOLS GOURMET & BAHIA  
COMPATIBLE WITH GOURMET & BAHIA BOWLS  
COMPATIBLE CON BOLES GOURMET & BAHIA



L

227828  
**TASSE ESPRESSO**  
DEMITASSE CUP  
ESPRESSO TAZA  
10 CL - 3 OZ<sup>3/8</sup>



L

227849  
**SOUCOUPE ESPRESSO**  
DEMITASSE SAUCER  
ESPRESSO PLATO  
12,6 CM - 4 IN<sup>15/16</sup>



L

227829  
**TASSE LUNGO**  
COFFEE/TEA CUP  
LUNGO TAZA  
25 CL - 8 OZ<sup>7/16</sup>



L

227850  
**SOUCOUPE LUNGO**  
COFFEE/TEA SAUCER  
LUNGO PLATO  
15,8 CM - 6 IN<sup>1/4</sup>



CÉRAMIQUE TEINTÉE MASSE  
MASS COLORED CERAMIC  
CERÁMICA COLORADO A TODA MESA



182301  
**CLOCHE INOX**  
DOME COVER, STAINLESS STEEL  
CAMPANA  
14,8 CM - Ø 5 IN<sup>13/16</sup>



**NEW** COLLECTION L  
PERLES DE ROSÉE

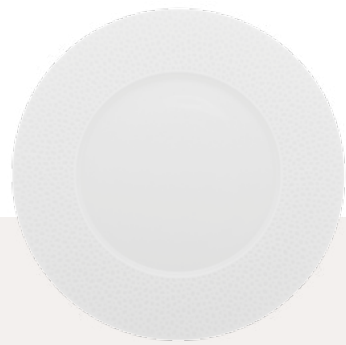

**L** **NEW**

233922  
**ASSIETTE DE PRÉSENTATION**  
ROUND PRESENTATION PLATE  
W/WIDE RIM  
PLATO REDONDO  
32 CM - 12 IN<sup>5/8</sup>

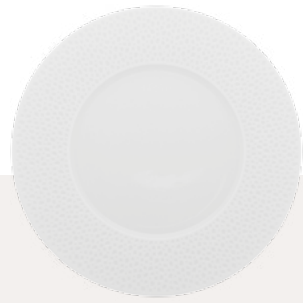

**L** **NEW**

233923  
**ASSIETTE PLATE**  
ROUND DINNER PLATE  
W/WIDE RIM  
PLATO REDONDO  
28 CM - 11 IN

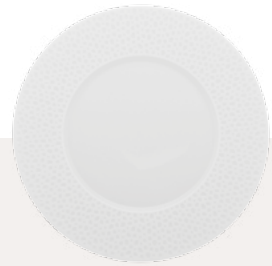

**L** **NEW**

233924  
**ASSIETTE DESSERT**  
ROUND DESSERT/SALAD/APP.PLATE  
W/WIDE RIM  
PLATO REDONDO  
24 CM - 9 IN<sup>7/16</sup>



**L** **NEW**

233925  
**ASSIETTE À PAIN**  
ROUND BREAD & BUTTER PLATE  
W/WIDE RIM  
PLATO REDONDO  
14 CM - 5 IN<sup>1/2</sup>



206504  
**BOUCHON PORCELAINE  
POUR CLOCHE VERRE**  
PORCELAIN LID FOR GLASS DOME COVER  
TAPA DE PORCELANA PARA  
CAMPANA DE VIDRIO  
5,2 CM - 2 IN<sup>7/16</sup>

COMPATIBLE AVEC LES GRANDES ASSIETTES COCOTTE GOURMET P.44  
COMPATIBLE WITH LARGE CASSEROLE PLATES GOURMET P.44  
COMPATIBLE CON GRANDES COCOTTE PLATOS GOURMET P.44



**L** **NEW**

233926  
**ASSIETTE GOURMET**  
ROUND SHALLOW BOWL W/WIDE RIM  
PLATO GOURMET  
30 CM - 11 IN<sup>3/16</sup>

209384



209383  
**BLANC BRILLANT**  
BRIGHT WHITE  
BLANCO BRILLANTE

209384



209720  
**BLANC SABLÉ**  
SANDY WHITE  
BLANCO PURO

230820



230821  
**BLEU**  
BLUE  
AZUL

204042



204041  
**CARBONE**  
GREY  
GRIS

AUTRES COULEURS  
OTHER COLORS  
OTROS COLORES



**BAHIA P.50**



204043  
**CLOCHE VERRE BOROSILICATE**  
GLASS DOME COVER  
CAMPANA VIDRIO BOROSILICATO  
17X9 CM - 6 IN<sup>11/16</sup> X 3 IN<sup>9/16</sup>

COMPATIBLE AVEC LES COCOTTES GOURMET & BAHIA  
COMPATIBLE WITH GOURMET & BAHIA ROUND CASSEROLES  
COMPATIBLE CON GOURMET & BAHIA COCOTTE BOLES



**L** **NEW**

233927  
**ASSIETTE GOURMET**  
ROUND SHALLOW BOWL W/WIDE RIM  
PLATO GOURMET  
28 CM - 11 IN



186849  
**BLANC BRILLANT**  
BRIGHT WHITE  
BLANCO BRILLANTE



211893  
**BLANC SABLÉ**  
SANDY WHITE  
BLANCO PURO



230822  
**BLEU**  
BLUE  
AZUL



234209  
**CARBONE**  
CARBONE/BLACK  
NEGRO

AUTRES COULEURS  
OTHER COLORS  
OTROS COLORES



**BAHIA P.50**



182614  
**CLOCHE INOX**  
DOME COVER, STAINLESS STEEL  
CAMPANA  
24 CM - Ø 9 IN<sup>7/16</sup>

COMPATIBLE AVEC LES BOLS GOURMET & BAHIA  
COMPATIBLE WITH GOURMET & BAHIA BOWLS  
COMPATIBLE CON BOLES GOURMET & BAHIA



227828  
**TASSE ESPRESSO**  
DEMITASSE CUP  
ESPRESSO TAZA  
10 CL - 3 OZ<sup>2/8</sup>



233928  
**SOUCOUBE ESPRESSO**  
DEMITASSE SAUCER  
ESPRESSO PLATO  
12,6 CM - 4 IN<sup>15/16</sup>



227829  
**TASSE LUNGO**  
COFFEE/TEA CUP  
LUNGO TAZA  
25 CL - 8 OZ<sup>7/16</sup>



233929  
**SOUCOUBE LUNGO**  
COFFEE/TEA SAUCER  
LUNGO PLATO  
15,8 CM - 5 IN<sup>7/16</sup>



CÉRAMIQUE TEINTÉE MASSE  
MASS COLORED CERAMIC  
CERÁMICA COLORADO A TODA MESA



182301  
**CLOCHE INOX**  
DOME COVER, STAINLESS STEEL  
CAMPANA  
14,8 CM - Ø 5 IN<sup>13/16</sup>





213936  
**ASSIETTE DE PRÉSENTATION**  
ROUND PRESENTATION PLATE  
W/WIDE RIM  
PLATO REDONDO  
32 CM - 12 IN<sup>3/8</sup>



213938  
**ASSIETTE PLATE**  
ROUND DINNER PLATE  
W/WIDE RIM  
PLATO REDONDO  
28 CM - 11 IN



213940  
**ASSIETTE DESSERT**  
ROUND DESSERT/SALAD/APP.PLATE  
W/WIDE RIM  
PLATO REDONDO  
24 CM - 9 IN<sup>7/16</sup>

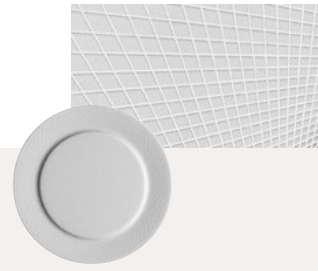

213942  
**ASSIETTE À PAIN**  
ROUND BREAD & BUTTER PLATE  
W/WIDE RIM  
PLATO REDONDO  
14 CM - 5 IN<sup>1/2</sup>



206504  
**BOUCHON PORCELAINE  
POUR CLOCHE VERRE**  
PORCELAIN LID FOR GLASS DOME COVER  
TAPA DE PORCELANA PARA  
CAMPANA DE VIDRIO  
5,2 CM - 2 IN<sup>1/8</sup>



204043  
**CLOCHE VERRE BOROSILICATE**  
GLASS DOME COVER  
CAMPANA VIDRIO BOROSILICATO  
17X9 CM - 6 IN<sup>17/16</sup> X 3 IN<sup>3/16</sup>

COMPATIBLE AVEC LES GRANDES ASSIETTES COCOTTE GOURMET P.44  
COMPATIBLE WITH LARGE CASSEROLE PLATES GOURMET P.44  
COMPATIBLE CON GRANDES COCOTTE PLATOS GOURMET P.44

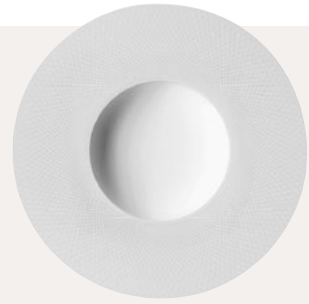

222366  
**ASSIETTE GOURMET**  
ROUND SHALLOW BOWL W/WIDE RIM  
PLATO GOURMET  
30 CM - 11 IN<sup>3/16</sup>



209384  
**BLANC BRILLANT**  
BRIGHT WHITE  
BLANCO BRILLANTE



209720  
**BLANC SABLÉ**  
SANDY WHITE  
BLANCO PURO



230820  
**BLEU**  
BLUE  
AZUL



204042  
**CARBONE**  
GREY  
GRIS



AUTRES COULEURS  
OTHER COLORS  
OTROS COLORES

BAHIA P.50



182614  
**CLOCHE INOX**  
DOME COVER, STAINLESS STEEL  
CAMPANA  
24 CM - Ø 9 IN<sup>7/16</sup>

**ASSIETTE/COUVERCLE DE COCOTTE ROND**  
ROUND PLATE/CASSEROLE LID  
BOL/PLATO RONDO PAN  
12,5 CM - 4 IN<sup>5/16</sup>

**COCOTTE GOURMET**  
GOURMET ROUND CASSEROLE  
COCOTTE BOL GOURMET  
14 CM - 5 IN<sup>1/2</sup>  
50 CL - 16 OZ<sup>15/16</sup>

COMPATIBLE AVEC LES COCOTTES GOURMET & BAHIA  
COMPATIBLE WITH GOURMET & BAHIA ROUND CASSEROLES  
COMPATIBLE CON GOURMET & BAHIA COCOTTE BOLES



222365  
**ASSIETTE GOURMET**  
ROUND SHALLOW BOWL W/WIDE RIM  
PLATO GOURMET  
28 CM - 11 IN



186849  
**BLANC BRILLANT**  
BRIGHT WHITE  
BLANCO BRILLANTE



211893  
**BLANC SABLÉ**  
SANDY WHITE  
BLANCO PURO



230822  
**BLEU**  
BLUE  
AZUL



234209  
**CARBONE**  
CARBONE/BLACK  
NEGRO



AUTRES COULEURS  
OTHER COLORS  
OTROS COLORES

BAHIA P.50



182301  
**CLOCHE INOX**  
DOME COVER, STAINLESS STEEL  
CAMPANA  
14,8 CM - Ø 5 IN<sup>13/16</sup>

**BOL GOURMET**  
GOURMET BOWL  
BOL GOURMET  
12 CM - 4 IN<sup>3/4</sup>  
30 CL - 10 OZ<sup>1/8</sup>

COMPATIBLE AVEC LES BOLS GOURMET & BAHIA  
COMPATIBLE WITH GOURMET & BAHIA BOWLS  
COMPATIBLE CON BOLES GOURMET & BAHIA



207756  
**TASSE ESPRESSO**  
DEMITASSE CUP  
ESPRESSO TAZA  
10 CL - 3 OZ<sup>3/8</sup>



223406  
**SOUCOUBE ESPRESSO**  
DEMITASSE SAUCER  
ESPRESSO PLATO  
12,5 CM - 4 IN<sup>5/16</sup>



207757  
**TASSE LUNGO**  
COFFEE/TEA CUP  
LUNGO TAZA  
20 CL - 6 OZ<sup>3/4</sup>



223407  
**SOUCOUBE LUNGO**  
COFFEE/TEA SAUCER  
LUNGO PLATO  
15 CM - 5 IN<sup>7/8</sup>



CÉRAMIQUE TEINTÉE MASSE  
MASS COLORED CERAMIC  
CERÁMICA COLORADO A TODA MESA



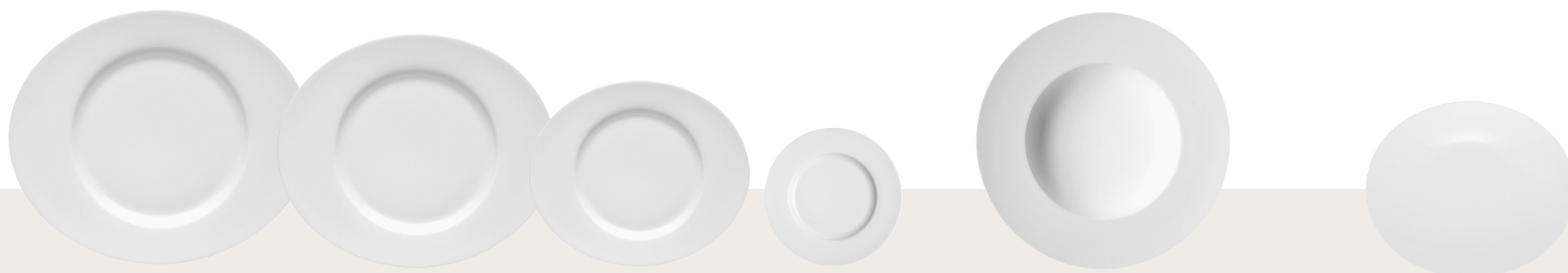

207137  
**ASSIETTE DE PRÉSENTATION OVALE**  
OVAL PRESENTATION PLATE  
PLATO PRESENTACIÓN OVAL  
34,5 X 29 CM - 13 IN<sup>3/8</sup> X 11 IN<sup>7/16</sup>

207134  
**ASSIETTE PLATE OVALE**  
OVAL DINNER PLATE  
PLATO OVAL  
31 X 26,5 CM - 12 IN<sup>3/16</sup> X 10 IN<sup>7/16</sup>

207135  
**ASSIETTE DESSERT OVALE**  
OVAL DESSERT PLATE  
PLATO OVAL  
24 X 20,5 CM - 9 IN<sup>7/16</sup> X 8 IN<sup>1/16</sup>

207139  
**ASSIETTE À PAIN RONDE**  
ROUND BREAD & BUTTER PLATE  
PLATO DE PAN REDONDO  
16 CM - 6 IN<sup>5/16</sup>

207140  
**ASSIETTE À PÂTES**  
ROUND SOUP/PASTA BOWL W/WIDE RIM  
PLATO HONDO PASTA REDONDA  
29 CM - 11 IN<sup>7/16</sup>

207136  
**ASSIETTE CALOTTE OVALE**  
OVAL SHALLOW BOWL, COUPE  
PLATO HONDO OVAL  
23,5 X 20 CM - 9 IN<sup>1/4</sup> X 7 IN<sup>7/16</sup>



204040  
**ASSIETTE GOURMET OVALE GRAND BASSIN**  
SHALLOW BOWL W/WIDE OVAL RIM  
PLATO GOURMET OVAL FONDO GRANDE  
32 X 27 CM - 12 IN<sup>5/8</sup> X 10 IN<sup>5/8</sup>  
27 CL - 9 OZ<sup>1/8</sup>



207141  
**ASSIETTE GOURMET OVALE BASSIN PLAT**  
OVAL PLATE W/WIDE - RIM, FLAT  
PLATO GOURMET OVAL  
30 X 26 CM - 11 IN<sup>13/16</sup> X 10 IN<sup>1/4</sup>

209384



209383  
**BLANC BRILLANT**  
BRIGHT WHITE  
BLANCO BRILLANTE

209384



209720  
**BLANC SABLÉ**  
SANDY WHITE  
BLANCO PURO

230820



230821  
**BLEU**  
BLUE  
AZUL

204042



204041  
**CARBONE**  
GREY  
GRIS

AUTRES COULEURS  
OTHER COLORS  
OTROS COLORES



**BAHIA P.50**

**ASSIETTE/COUVERCLE DE COCOTTE ROND**  
ROUND PLATE/CASSEROLE LID  
BOL/PLATO RONDO PAN  
12,5 CM - 4 IN<sup>5/16</sup>

**COCOTTE GOURMET**  
GOURMET ROUND CASSEROLE  
COCOTTE BOL GOURMET  
14 CM - 5 IN<sup>1/2</sup>  
50 CL - 16 OZ<sup>5/16</sup>

206504  
**BOUCHON PORCELAINE POUR CLOCHE VERRE**  
PORCELAIN LID FOR GLASS DOME COVER  
TAPA DE PORCELANA PARA CAMPANA DE VIDRIO  
5,2 CM - 2 IN<sup>1/16</sup>



204043  
**CLOCHE VERRE BOROSILICATE**  
GLASS DOME COVER  
CAMPANA VIDRIO BOROSILICATO  
17X9 CM - 6 IN<sup>1/16</sup> X 3 IN<sup>5/16</sup>

COMPATIBLE AVEC LES COCOTTES GOURMET & BAHIA  
COMPATIBLE WITH GOURMET & BAHIA ROUND CASSEROLES  
COMPATIBLE CON GOURMET & BAHIA COCOTTE BOLES



207138  
**ASSIETTE GOURMET OVALE PETIT BASSIN**  
SHALLOW BOWL W/WIDE OVAL RIM  
PLATO GOURMET OVAL FONDO PEQUEÑO  
30 X 26 CM - 11 IN<sup>13/16</sup> X 10 IN<sup>1/4</sup>  
17 CL - 5 OZ<sup>3/4</sup>



186849  
**BLANC BRILLANT**  
BRIGHT WHITE  
BLANCO BRILLANTE  
**BOL GOURMET**  
GOURMET BOWL  
BOL GOURMET  
12 CM - 4 IN<sup>3/4</sup>  
30 CL - 10 OZ<sup>1/8</sup>



211893  
**BLANC SABLÉ**  
SANDY WHITE  
BLANCO PURO



230822  
**BLEU**  
BLUE  
AZUL



234209  
**CARBONE**  
CARBONE/BLACK  
NEGRO

AUTRES COULEURS  
OTHER COLORS  
OTROS COLORES



**BAHIA P.50**



182614  
**CLOCHE INOX**  
DOME COVER, STAINLESS STEEL  
CAMPANA  
24 CM - Ø 9 IN<sup>7/16</sup>

COMPATIBLE AVEC LES BOLS GOURMET & BAHIA  
COMPATIBLE WITH GOURMET & BAHIA BOWLS  
COMPATIBLE CON BOLES GOURMET & BAHIA



182301  
**CLOCHE INOX**  
DOME COVER, STAINLESS STEEL  
CAMPANA  
14,8 CM - Ø 5 IN<sup>13/16</sup>



CÉRAMIQUE TEINTÉE MASSE  
MASS COLORED CERAMIC  
CERÁMICA COLORADO A TODA MESA







186782  
**SALADIER**  
SALAD BOWL DEEP  
ENSALADERA  
28 X 24 CM - 11 IN X 9 IN<sup>7/16</sup>  
H : 11 CM - 4 IN<sup>5/16</sup>



186779  
**COUPELLE**  
DEEP BOWL, SMALL  
BOL  
14 X 12 CM - 5 IN<sup>1/2</sup> X 4 IN<sup>3/4</sup>  
H : 5 CM - 4 IN<sup>5/16</sup>



186797  
**VERRINE**  
RAMEKIN  
VASO  
6 CL - 2 OZ  
H : 5,5 CM - 2 IN<sup>3/16</sup>



186851  
**VERRINE**  
RAMEKIN  
VASO  
12 CL - 4 OZ<sup>1/16</sup>  
H : 7 CM - 2 IN<sup>3/4</sup>

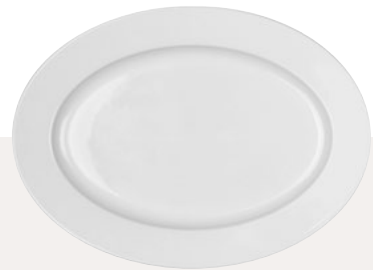

200102  
**PLAT OVAL CREUX**  
OVAL CHOP PLATE W/RIM, FLAT  
PLATO HONDO OVOLADO  
36,5 X 26,5 CM - 14 IN<sup>3/8</sup> X 10 IN<sup>7/16</sup>



186788  
**PLAT À CAKE**  
OVAL LONG DISH W/WIDE RIM, FLAT  
FUENTE OVOLADO  
40,5 X 19 CM - 15 IN<sup>5/16</sup> X 7 IN<sup>1/2</sup>

NEWPORT CAFÉTERIE - TEATIME - TÉ CAFÉ



207756  
**TASSE ESPRESSO**  
DEMITASSE CUP  
ESPRESSO TAZA  
10 CL - 3 OZ<sup>3/8</sup>



207757  
**TASSE LUNGO**  
COFFEE/TEA CUP  
LUNGO TAZA  
20 CL - 6 OZ<sup>3/4</sup>



207758  
**TASSE DÉJEUNER**  
BREAKFAST CUP  
TAZA DESAYUNO  
40 CL - 13 OZ<sup>1/2</sup>

207759  
**SOUCOUPE ESPRESSO**  
DEMITASSE SAUCER  
ESPRESSO PLATO  
12,5 CM - 4 IN<sup>5/16</sup>

207760  
**SOUCOUPE LUNGO**  
COFFEE/TEA SAUCER  
LUNGO PLATO  
15,8 CM - 5 IN<sup>7/8</sup>

207761  
**SOUCOUPE DÉJEUNER**  
BREAKFAST SAUCER  
PLATO DESAYUNO  
18 CM - 7 IN<sup>7/8</sup>



207763  
**VERSEUSE**  
COFFEE/TEA POT  
CAFETERA/TETERA  
40 CL - 13 OZ<sup>1/2</sup>



207764  
**VERSEUSE**  
COFFEE/TEA POT  
CAFETERA/TETERA  
80 CL - 27 OZ<sup>1/16</sup>



207762  
**CRÉMIER**  
CREAM JUG  
LECHERA  
10 CL - 3 OZ<sup>3/8</sup>



**COUVERCLES VERSEUSES**  
LIDS FOR TEA POTS  
TAPAS CAFETERAS  
210911 210912  
6,6 CM - 2 IN<sup>5/8</sup> 8,4 CM - 3 IN<sup>5/16</sup>  
40 CL - 13 OZ<sup>1/2</sup> 80 CL - 27 OZ<sup>1/16</sup>





# BORÉAL SATIN

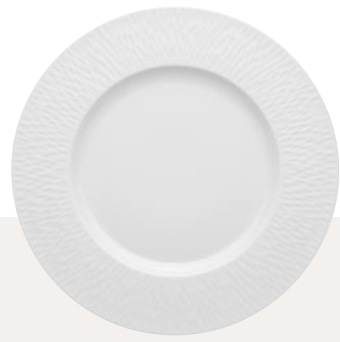

193319  
**ASSIETTE DE PRÉSENTATION RONDE**  
ROUND PRESENTATION PLATE  
W/WIDE RIM  
PLATO PRESENTACIÓN REDONDO  
33 CM - 13 IN



193318  
**ASSIETTE PLATE RONDE**  
ROUND DINNER PLATE  
W/WIDE RIM  
PLATO REDONDO  
28,5 CM - 11 IN<sup>1/4</sup>



193320  
**ASSIETTE DESSERT RONDE**  
ROUND DESSERT/SALAD/APP.PLATE  
W/WIDE RIM  
PLATO REDONDO  
22,5 CM - 8 IN<sup>7/8</sup>



202470  
**ASSIETTE À PAIN RONDE**  
ROUND BREAD & BUTTER PLATE  
PLATO DE PAN REDONDO  
15 CM - 5 IN<sup>7/8</sup>



223954  
**ASSIETTE À PÂTES/SOUBE RONDE**  
ROUND SOUP/PASTA BOWL  
W/WIDE RIM  
PLATO HONDO PASTA REDONDA  
29 CM - 11 IN<sup>7/16</sup>



207769  
**ASSIETTE GOURMET OVALE GRAND BASSIN**  
SHALLOW BOWL W/WIDE OVAL RIM  
SATIN FINISH  
PLATO GOURMET OVAL FONDO GRANDE  
32 X 27 CM - 12 IN<sup>5/8</sup> X 10 IN<sup>5/8</sup>  
27 CL - 9 OZ<sup>1/8</sup>

209384



209383  
**BLANC BRILLANT**  
BRIGHT WHITE  
BLANCO BRILLANTE

209384



209720  
**BLANC SABLÉ**  
SANDY WHITE  
BLANCO PURO

230820



230821  
**BLEU**  
BLUE  
AZUL

204042



204041  
**CARBONE**  
GREY  
GRIS

AUTRES COULEURS  
OTHER COLORS  
OTROS COLORES



BAHIA P.50

206504

**BOUCHON PORCELAINE POUR CLOCHE VERRE**  
PORCELAIN LID FOR GLASS DOME COVER  
TAPA DE PORCELANA PARA CAMPANA DE VIDRIO  
5,2 CM - 2 IN<sup>7/16</sup>



204043

**CLOCHE VERRE BOROSILICATE**  
GLASS DOME COVER  
CAMPANA VIDRIO BOROSILICATO  
17X9 CM - 6 IN<sup>11/16</sup> X 3 IN<sup>9/16</sup>

COMPATIBLE AVEC LES COCOTTES GOURMET & BAHIA  
COMPATIBLE WITH GOURMET & BAHIA ROUND CASSEROLES  
COMPATIBLE CON GOURMET & BAHIA COCOTTE BOLES



193324  
**ASSIETTE GOURMET OVALE PETIT BASSIN**  
SHALLOW BOWL W/WIDE OVAL RIM  
SATIN FINISH  
PLATO GOURMET OVAL FONDO PEQUEÑO  
30 X 26 CM - 11 IN<sup>13/16</sup> X 10 IN<sup>1/4</sup>  
17 CL - 5 OZ<sup>3/4</sup>



186849  
**BLANC BRILLANT**  
BRIGHT WHITE  
BLANCO BRILLANTE



211893  
**BLANC SABLÉ**  
SANDY WHITE  
BLANCO PURO



230822  
**BLEU**  
BLUE  
AZUL



234209  
**CARBONE**  
CARBONE/BLACK  
NEGRO

AUTRES COULEURS  
OTHER COLORS  
OTROS COLORES



BAHIA P.50



182614  
**CLOCHE INOX**  
DOME COVER, STAINLESS STEEL  
CAMPANA  
24 CM - Ø 9 IN<sup>7/16</sup>

COMPATIBLE AVEC LES BOLS GOURMET & BAHIA  
COMPATIBLE WITH GOURMET & BAHIA BOWLS  
COMPATIBLE CON BOLES GOURMET & BAHIA



182301  
**CLOCHE INOX**  
DOME COVER, STAINLESS STEEL  
CAMPANA  
14,8 CM - Ø 5 IN<sup>13/16</sup>



CÉRAMIQUE TEINTÉE MASSE  
MASS COLORED CERAMIC  
CERÁMICA COLORADO A TODA MESA



# BORÉAL SATIN

DORÉ - GOLDED - DORADO



225193  
**ASSIETTE DE PRÉSENTATION**  
PRESENTATION PLATE W/WIDE RIM  
PLATO PRESENTACIÓN  
33 CM - 13 IN

225194  
**ASSIETTE PLATE**  
DINNER PLATE W/WIDE RIM  
PLATO REDONDO  
28,5 CM - 11 IN<sup>1/4</sup>

225195  
**ASSIETTE DESSERT**  
DESSERT/SALAD/APP.PLATE  
W/WIDE RIM  
PLATO REDONDO  
22,5 CM - 8 IN<sup>7/8</sup>

**NEW**



225196\*  
**ASSIETTE À PAIN RONDE**  
ROUND BREAD & BUTTER PLATE  
PLATO DE PAN REDONDO  
14 CM - 5 IN<sup>1/2</sup>



225197  
**ASSIETTE GOURMET OVALE  
PETIT BASSIN**  
SHALLOW BOWL W/WIDE OVAL RIM  
PLATO GOURMET OVAL FONDO PEQUEÑO  
30 X 26 CM - 27 CL - 11 IN<sup>3/16</sup> X 10 IN<sup>1/4</sup> - 9 OZ

\* FABRICATION SUR DEMANDE  
AVAILABLE ON REQUEST

ARGENT - SILVERPLATED - PLATEADO



225198  
**ASSIETTE DE PRÉSENTATION**  
PRESENTATION PLATE W/WIDE RIM  
PLATO PRESENTACIÓN  
33 CM - 13 IN

NEWPORT CAFÉTERIE - TEATIME - TÉ CAFÉ



**COUVERCLES VERSEUSES**  
LIDS FOR TEA POTS  
TAPAS CAFETERAS  
210911 210912  
6,6 CM - 2 IN<sup>5/8</sup> 8,4 CM - 3 IN<sup>5/16</sup>  
40 CL - 13 OZ<sup>1/2</sup> 80 CL - 27 OZ<sup>1/16</sup>



207756  
**TASSE ESPRESSO**  
DEMITASSE CUP  
ESPRESSO TAZA  
10 CL - 3 OZ<sup>2/8</sup>  
207759  
**SOUCOUPE ESPRESSO**  
DEMITASSE SAUCER  
ESPRESSO PLATO  
12,5 CM - 4 IN<sup>5/16</sup>



207757  
**TASSE LUNGO**  
COFFEE/TEA CUP  
LUNGO TAZA  
20 CL - 6 OZ<sup>3/4</sup>  
207760  
**SOUCOUPE LUNGO**  
COFFEE/TEA SAUCER  
LUNGO PLATO  
15,8 CM - 5 IN<sup>7/16</sup>



207758  
**TASSE DÉJEUNER**  
BREAKFAST CUP  
TAZA DESAYUNO  
40 CL - 13 OZ<sup>1/2</sup>  
207761  
**SOUCOUPE DÉJEUNER**  
BREAKFAST SAUCER  
PLATO DESAYUNO  
18 CM - 7 IN<sup>7/16</sup>



207763  
**VERSEUSE**  
COFFEE/TEA POT  
CAFETERA/TETERA  
40 CL - 13 OZ<sup>1/2</sup>



207764  
**VERSEUSE**  
COFFEE/TEA POT  
CAFETERA/TETERA  
80 CL - 27 OZ<sup>1/16</sup>



207762  
**CRÉMIER**  
CREAM JUG  
LECHERA  
10 CL - 3 OZ<sup>3/8</sup>



@Julie Anisau



BLANC - WHITE - BLANCO



234342  
**GRANDE ASSIETTE COCOTTE**  
LARGE CASSEROLE PLATE  
GRANDE COCOTTE/PLATO  
22 CM - 8 IN<sup>11/16</sup>  
100 CL - 33 OZ<sup>13/16</sup>



235064  
**GRANDE ASSIETTE COCOTTE**  
LARGE CASSEROLE PLATE  
GRANDE COCOTTE/PLATO  
18 CM - 7 IN<sup>7/16</sup>  
70 CL - 23 OZ<sup>11/16</sup>



234341  
**COCOTTE**  
ROUND CASSEROLE  
COCOTTE/BOL  
17,5 CM - 6 IN<sup>7/8</sup>  
140 CL - 47 OZ<sup>5/16</sup>



209384  
**ASSIETTE/COUVERCLE DE COCOTTE ROND**  
ROUND PLATE/CASSEROLE LID  
BOL/PLATO PAN RONDO  
12,5 CM - 4 IN<sup>5/16</sup>



234340  
**BOL**  
BOWL  
BOL  
16 CM - 6 IN<sup>5/16</sup>  
100 CL - 33 OZ<sup>13/16</sup>



186849  
**BOL**  
BOWL  
BOL  
12 CM - 4 IN<sup>3/4</sup>  
30 CL - 10 OZ<sup>1/8</sup>



211891  
**MINI BOL**  
MINI BOWL  
MINI BOL  
7,3 CM - 2 IN<sup>7/8</sup>  
7 CL - 2 OZ<sup>3/8</sup>



209383  
**COCOTTE**  
ROUND CASSEROLE  
COCOTTE BOL  
14 CM - 5 IN<sup>1/2</sup>  
50 CL - 16 OZ<sup>5/16</sup>

BLANC SABLÉ - SANDY WHITE - ACABADO COLOR ARENA



234345  
**GRANDE ASSIETTE COCOTTE**  
LARGE CASSEROLE PLATE  
GRANDE COCOTTE/PLATO  
22 CM - 8 IN<sup>11/16</sup>  
100 CL - 33 OZ<sup>13/16</sup>



235065  
**GRANDE ASSIETTE COCOTTE**  
LARGE CASSEROLE PLATE  
GRANDE COCOTTE/PLATO  
18 CM - 7 IN<sup>7/16</sup>  
70 CL - 23 OZ<sup>11/16</sup>



234344  
**COCOTTE**  
ROUND CASSEROLE  
COCOTTE/BOL  
17,5 CM - 6 IN<sup>7/8</sup>  
140 CL - 47 OZ<sup>5/16</sup>



209384  
**ASSIETTE/COUVERCLE DE COCOTTE ROND**  
ROUND PLATE/CASSEROLE LID  
BOL/PLATO PAN RONDO  
12,5 CM - 4 IN<sup>5/16</sup>



234343  
**BOL**  
BOWL  
BOL  
16 CM - 6 IN<sup>5/16</sup>  
100 CL - 33 OZ<sup>13/16</sup>



211893  
**BOL**  
BOWL  
BOL  
12 CM - 4 IN<sup>3/4</sup>  
30 CL - 10 OZ<sup>1/8</sup>



211892  
**MINI BOL**  
MINI BOWL  
MINI BOL  
7,3 CM - 2 IN<sup>7/8</sup>  
7 CL - 2 OZ<sup>3/8</sup>



209720  
**COCOTTE**  
ROUND CASSEROLE  
COCOTTE BOL  
14 CM - 5 IN<sup>1/2</sup>  
50 CL - 16 OZ<sup>5/16</sup>

CARBONE - CARBONE/BLACK - NEGRO



234336  
**GRANDE ASSIETTE COCOTTE**  
LARGE CASSEROLE PLATE  
GRANDE COCOTTE/PLATO  
22 CM - 8 IN<sup>11/16</sup>  
100 CL - 33 OZ<sup>13/16</sup>



235066  
**GRANDE ASSIETTE COCOTTE**  
LARGE CASSEROLE PLATE  
GRANDE COCOTTE/PLATO  
18 CM - 7 IN<sup>7/16</sup>  
70 CL - 23 OZ<sup>11/16</sup>



234335  
**COCOTTE**  
ROUND CASSEROLE  
COCOTTE/BOL  
17,5 CM - 6 IN<sup>7/8</sup>  
140 CL - 47 OZ<sup>5/16</sup>



204042  
**ASSIETTE/COUVERCLE DE COCOTTE ROND**  
ROUND PLATE/CASSEROLE LID  
BOL/PLATO PAN RONDO  
12,5 CM - 4 IN<sup>5/16</sup>



234334  
**BOL**  
BOWL  
BOL  
16 CM - 6 IN<sup>5/16</sup>  
100 CL - 33 OZ<sup>13/16</sup>



234209  
**BOL**  
BOWL  
BOL  
12 CM - 4 IN<sup>3/4</sup>  
30 CL - 10 OZ<sup>1/8</sup>



234208  
**MINI BOL**  
MINI BOWL  
MINI BOL  
7,3 CM - 2 IN<sup>7/8</sup>  
7 CL - 2 OZ<sup>3/8</sup>

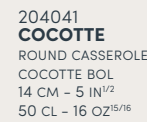

204041  
**COCOTTE**  
ROUND CASSEROLE  
COCOTTE BOL  
14 CM - 5 IN<sup>1/2</sup>  
50 CL - 16 OZ<sup>5/16</sup>

BLEU - BLUE - AZUL



234339  
**GRANDE ASSIETTE COCOTTE**  
LARGE CASSEROLE PLATE  
GRANDE COCOTTE/PLATO  
22 CM - 8 IN<sup>11/16</sup>  
100 CL - 33 OZ<sup>13/16</sup>



235063  
**GRANDE ASSIETTE COCOTTE**  
LARGE CASSEROLE PLATE  
GRANDE COCOTTE/PLATO  
18 CM - 7 IN<sup>7/16</sup>  
70 CL - 23 OZ<sup>11/16</sup>



234338  
**COCOTTE**  
ROUND CASSEROLE  
COCOTTE/BOL  
17,5 CM - 6 IN<sup>7/8</sup>  
140 CL - 47 OZ<sup>5/16</sup>



230820  
**ASSIETTE/COUVERCLE DE COCOTTE ROND**  
ROUND PLATE/CASSEROLE LID  
BOL/PLATO PAN RONDO  
12,5 CM - 4 IN<sup>5/16</sup>



234337  
**BOL**  
BOWL  
BOL  
16 CM - 6 IN<sup>5/16</sup>  
100 CL - 33 OZ<sup>13/16</sup>



230822  
**BOL**  
BOWL  
BOL  
12 CM - 4 IN<sup>3/4</sup>  
30 CL - 10 OZ<sup>1/8</sup>



230823  
**MINI BOL**  
MINI BOWL  
MINI BOL  
7,3 CM - 2 IN<sup>7/8</sup>  
7 CL - 2 OZ<sup>3/8</sup>

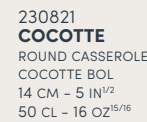

230821  
**COCOTTE**  
ROUND CASSEROLE  
COCOTTE BOL  
14 CM - 5 IN<sup>1/2</sup>  
50 CL - 16 OZ<sup>5/16</sup>





DUNE - BEIGE DUNE - BEIS DUNA



230921  
**ASSIETTE PLATE**  
ROUND DINNER PLATE  
PLATO REDONDO  
29 CM - 11 IN<sup>7/8</sup>

230920  
**ASSIETTE PLATE**  
ROUND DINNER PLATE  
PLATO REDONDO  
26 CM - 10 IN<sup>1/4</sup>

230919  
**ASSIETTE PLATE**  
ROUND DINNER PLATE  
PLATO REDONDO  
23 CM - 9 IN<sup>1/8</sup>



230922  
**ASSIETTE CREUSE**  
ROUND DEEP PLATE  
PLATO HONDO  
20 CM - 7 IN<sup>7/8</sup>



230918  
**ASSIETTE À PAIN**  
ROUND BREAD & BUTTER PLATE  
PLATO DE PAN  
14 CM - 5 IN<sup>1/2</sup>



230929  
**TASSE À ESPRESSO**  
ESPRESSO CUP  
TAZA DE ESPRESSO  
11 CL - 3 OZ<sup>3/4</sup>



230931  
**TASSE À THÉ**  
COFFEE/TEA CUP  
TAZA DE TÉ  
20 CL - 6 OZ<sup>3/4</sup>



230930  
**MUG À THÉ**  
TEA MUG  
MUG  
38 CL - 12 OZ<sup>7/8</sup>

BASALTE - BROWN BASALT - BASALTO



230938  
**ASSIETTE PLATE**  
ROUND DINNER PLATE  
PLATO REDONDO  
29 CM - 11 IN<sup>7/8</sup>

230937  
**ASSIETTE PLATE**  
ROUND DINNER PLATE  
PLATO REDONDO  
26 CM - 10 IN<sup>1/4</sup>

230936  
**ASSIETTE PLATE**  
ROUND DINNER PLATE  
PLATO REDONDO  
23 CM - 9 IN<sup>1/8</sup>



230939  
**ASSIETTE CREUSE**  
ROUND DEEP PLATE  
PLATO HONDO  
20 CM - 7 IN<sup>7/8</sup>



230935  
**ASSIETTE À PAIN**  
ROUND BREAD & BUTTER PLATE  
PLATO DE PAN  
14 CM - 5 IN<sup>1/2</sup>



230946  
**TASSE À ESPRESSO**  
ESPRESSO CUP  
TAZA DE ESPRESSO  
11 CL - 3 OZ<sup>3/4</sup>



230948  
**TASSE À THÉ**  
COFFEE/TEA CUP  
TAZA DE TÉ  
20 CL - 6 OZ<sup>3/4</sup>



230947  
**MUG À THÉ**  
TEA MUG  
MUG  
38 CL - 12 OZ<sup>7/8</sup>

ARGILE VERTE - GREEN CLAY - ARCILLA VERDE



230952  
**ASSIETTE PLATE**  
ROUND DINNER PLATE  
PLATO REDONDO  
29 CM - 11 IN<sup>7/8</sup>

230951  
**ASSIETTE PLATE**  
ROUND DINNER PLATE  
PLATO REDONDO  
26 CM - 10 IN<sup>1/4</sup>

230950  
**ASSIETTE PLATE**  
ROUND DINNER PLATE  
PLATO REDONDO  
23 CM - 9 IN<sup>1/8</sup>



230953  
**ASSIETTE CREUSE**  
ROUND DEEP PLATE  
PLATO HONDO  
20 CM - 7 IN<sup>7/8</sup>



230949  
**ASSIETTE À PAIN**  
ROUND BREAD & BUTTER PLATE  
PLATO DE PAN  
14 CM - 5 IN<sup>1/2</sup>



230960  
**TASSE À ESPRESSO**  
ESPRESSO CUP  
TAZA DE ESPRESSO  
11 CL - 3 OZ<sup>3/4</sup>



230962  
**TASSE À THÉ**  
COFFEE/TEA CUP  
TAZA DE TÉ  
20 CL - 6 OZ<sup>3/4</sup>



230961  
**MUG À THÉ**  
TEA MUG  
MUG  
38 CL - 12 OZ<sup>7/8</sup>



© Patrick ROUGÉREAU



BAHIA

ROSE SABLE - PINK SAND - ROSA ARENA



230904  
**ASSIETTE PLATE**  
ROUND DINNER PLATE  
PLATO REDONDO  
29 CM - 11 IN<sup>7/8</sup>

230903  
**ASSIETTE PLATE**  
ROUND DINNER PLATE  
PLATO REDONDO  
26 CM - 10 IN<sup>1/4</sup>

230902  
**ASSIETTE PLATE**  
ROUND DINNER PLATE  
PLATO REDONDO  
23 CM - 9 IN<sup>1/8</sup>



230905  
**ASSIETTE CREUSE**  
ROUND DEEP PLATE  
PLATO HONDO  
20 CM - 7 IN<sup>7/8</sup>



230901  
**ASSIETTE À PAIN**  
ROUND BREAD & BUTTER PLATE  
PLATO DE PAN  
14 CM - 5 IN<sup>1/2</sup>



230912  
**TASSE À ESPRESSO**  
ESPRESSO CUP  
TAZA DE ESPRESSO  
11 CL - 3 OZ<sup>3/4</sup>



230914  
**TASSE À THÉ**  
COFFEE/TEA CUP  
TAZA DE TÉ  
20 CL - 6 OZ<sup>3/4</sup>



230913  
**MUG À THÉ**  
TEA MUG  
MUG  
38 CL - 12 OZ<sup>7/8</sup>

BLEU DE ROCHE - BLUE STONE - AZUL DE ROCA

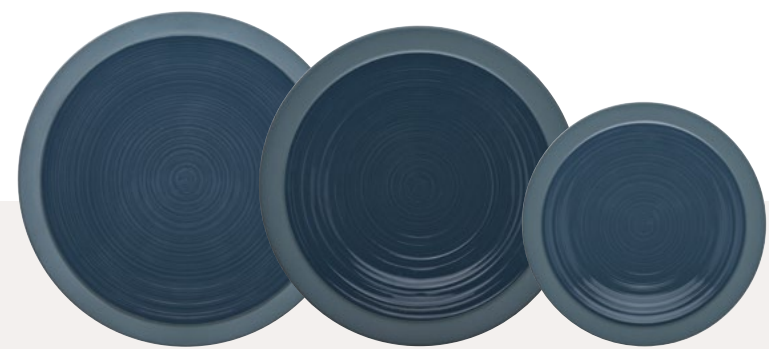

230966  
**ASSIETTE PLATE**  
ROUND DINNER PLATE  
PLATO REDONDO  
29 CM - 11 IN<sup>7/8</sup>

230965  
**ASSIETTE PLATE**  
ROUND DINNER PLATE  
PLATO REDONDO  
26 CM - 10 IN<sup>1/4</sup>

230964  
**ASSIETTE PLATE**  
ROUND DINNER PLATE  
PLATO REDONDO  
23 CM - 9 IN<sup>1/8</sup>



230967  
**ASSIETTE CREUSE**  
ROUND DEEP PLATE  
PLATO HONDO  
20 CM - 7 IN<sup>7/8</sup>



230963  
**ASSIETTE À PAIN**  
ROUND BREAD & BUTTER PLATE  
PLATO DE PAN  
14 CM - 5 IN<sup>1/2</sup>



230974  
**TASSE À ESPRESSO**  
ESPRESSO CUP  
TAZA DE ESPRESSO  
11 CL - 3 OZ<sup>3/4</sup>



230976  
**TASSE À THÉ**  
COFFEE/TEA CUP  
TAZA DE TÉ  
20 CL - 6 OZ<sup>3/4</sup>



230975  
**MUG À THÉ**  
TEA MUG  
MUG  
38 CL - 12 OZ<sup>7/8</sup>





DUNE - BEIGE DUNE - BEIS DUNA

230928  
230927



230924

230926



230923



230925

BASALTE - BROWN BASALT - BASALTO

230945  
230944



230941

230943



230940



230942

ARGILE VERTE - GREEN CLAY - ARCILLA VERDE

230959  
230958



230955

230957



230954



230956

BLEU DE ROCHE - BLUE STONE - AZUL DE ROCA

230973  
230972



230969

230971



230968



230970

ROSE SABLE - PINK SAND - ROSA ARENA

230911  
230910



230907

230909



230906



230908

**ASSIETTE/COUVERCLE DE COCOTTE ROND**  
ROUND PLATE/CASSEROLE LID  
BOL/PLATO RONDO PAN  
12,5 CM - 4 IN<sup>5/16</sup>

**COCOTTE**  
ROUND CASSEROLE  
COCOTTE BOL  
14 CM - 5 IN<sup>1/2</sup>  
50 CL - 16 OZ<sup>5/16</sup>

**ASSIETTE GOURMET GRAND BASSIN**  
SHALLOW BOWL W/WIDE ROUND RIM  
PLATO GOURMET HONDO FONDO GRANDE  
26 CM - 10 IN<sup>1/4</sup>

**BOL**  
BOWL  
BOL  
12 CM - 4 IN<sup>3/4</sup>  
30 CL - 10 OZ<sup>2/8</sup>

**ASSIETTE GOURMET PETIT BASSIN**  
SHALLOW BOWL W/WIDE ROUND RIM  
PLATO GOURMET REDONDO FONDO PEQUEÑO  
23 CM - 9 IN<sup>1/8</sup>

**MINI BOL**  
SMALL BOWL  
MINI BOL  
7,3 CM - 2 IN<sup>7/8</sup>  
7 CL - 2 OZ



206504  
**BOUCHON PORCELAINE POUR CLOCHE VERRE**  
PORCELAIN LID FOR GLASS DOME COVER  
TAPA DE PORCELANA PARA CAMPANA DE VIDRIO  
5,2 CM - 2 IN<sup>17/16</sup>



204043  
**CLOCHE VERRE BOROSILICATE**  
GLASS DOME COVER  
CAMPANA VIDRIO BOROSILICATO  
17X9 CM - 6 IN<sup>17/16</sup> X 3 IN<sup>9/16</sup>



182614  
**CLOCHE INOX**  
DOME COVER, STAINLESS STEEL  
CAMPANA  
24 CM - Ø 9 IN<sup>7/16</sup>



182301  
**CLOCHE INOX**  
DOME COVER, STAINLESS STEEL  
CAMPANA  
14,8 CM - Ø 5 IN<sup>13/16</sup>





MODULO NATURE

PIERRE DE LAVE - LAVA STONE - PIEDRA DE LAVA



NEW

194455  
**ASSIETTE DE PRÉSENTATION**  
PRESENTATION PLATE, COUPE  
PLATO PRESENTACIÓN  
31,5 CM - 12 IN<sup>3/8</sup>

194454  
**ASSIETTE PLATE**  
DINNER PLATE, COUPE  
PLATO REDONDO  
28 CM - 11 IN

194453  
**ASSIETTE DESSERT**  
DESSERT/SALAD PLATE, COUPE  
PLATO ILANO  
21 CM - 8 IN<sup>1/4</sup>

234455  
**COUPE RONDE**  
ROUND CUP  
BOL  
25 CM - 9 IN<sup>13/16</sup>

194452  
**ASSIETTE CALOTTE**  
SALAD/CEREAL PLATE  
PLATO HONDO  
21 CM - 8 IN<sup>1/4</sup>

230092  
**ASSIETTE À PAIN**  
BREAD & BUTTER PLATE, COUPE  
PLATO DE PAN  
16 CM - 6 IN<sup>5/16</sup>



194462  
**SALADIER**  
SALAD BOWL, DEEP  
ENSALADERA  
24 CM - 9 IN<sup>2/16</sup>  
H : 8 CM - 3 IN<sup>3/16</sup>



194457  
**COUPE/CALOTTE**  
SALAD /CEREAL PLATE, DEEP  
BOL  
17,7 CM - 6 IN<sup>15/16</sup>  
H : 5,5 CM - 2 IN<sup>3/16</sup>



194456  
**BOL À DEJEUNER**  
SOUP/BREAKFAST BOWL  
BOL DESAYUNO  
14 CM - 5,8 CL  
5 IN<sup>1/2</sup> - 19 OZ<sup>5/8</sup>



194458  
**COUPELLE**  
SMALL BOWL, CUP  
BOL PEQUEÑO  
10 CM - 3 IN<sup>15/16</sup>  
H : 6 CM - 2 IN<sup>3/8</sup>



194459  
**TASSE À CAFÉ**  
DEMITASSE CUP  
TAZA DE CAFÉ  
11,5 CL - 3 OZ<sup>7/16</sup>

194460  
**SOUCOUBE À CAFÉ**  
DEMITASSE SAUCER  
ESPRESSO CAFÉ  
12,5 CM - 4 IN<sup>15/16</sup>



230093  
**TASSE À THÉ**  
TEA CUP  
TAZA DE TÉ  
25 CL - 8 OZ<sup>2/16</sup>

230094  
**SOUCOUBE À THÉ**  
DEMITASSE /TEA SAUCER  
PLATO TÉ  
15 CM - 5 OZ<sup>2/16</sup>



194461  
**MUG À THÉ**  
MUG  
TÈ MUG  
33 CL - 11 OZ<sup>3/16</sup>





MODULO NATURE

BLEU GALET - BLUE - AZUL

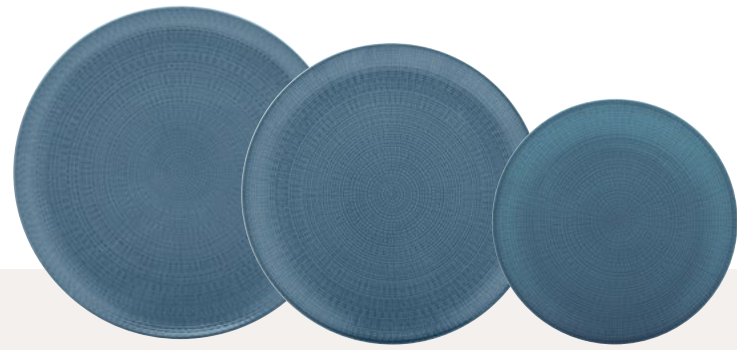

225342  
**ASSIETTE DE PRÉSENTATION**  
PRESENTATION PLATE, COUPE  
PLATO PRESENTACIÓN  
31,5 CM - 12 IN<sup>3/8</sup>

225343  
**ASSIETTE PLATE**  
DINNER PLATE, COUPE  
PLATO REDONDO  
28 CM - 11 IN

225344  
**ASSIETTE DESSERT**  
DESSERT SALAD PLATE, COUPE  
PLATO ILANO  
21 CM - 8 IN<sup>1/4</sup>



225345  
**ASSIETTE CALOTTE**  
SALAD / CEREAL PLATE  
PLATO HONDO  
21 CM - 8 IN<sup>1/4</sup>

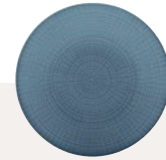

225353  
**ASSIETTE À PAIN**  
BREAD & BUTTER PLATE, COUPE  
PLATO DE PAN  
16 CM - 6 IN<sup>5/16</sup>



225349  
**SALADIER**  
SALAD BOWL, DEEP  
ENSALADERA  
24 CM - 9 IN<sup>7/16</sup>  
H : 8 CM - 3 IN<sup>3/8</sup>

225347  
**COUPE/CALOTTE**  
SALAD / CEREAL PLATE, DEEP  
BOL  
17,7 CM - 6 IN<sup>15/16</sup>  
H : 5,5 CM - 2 IN<sup>3/16</sup>



225346  
**COUPELLE**  
SMALL BOWL, CUP  
BOL PEQUEÑO  
10 CM - 3 IN<sup>5/16</sup>  
H : 6 CM - 2 IN<sup>3/8</sup>



225351  
**TASSE À CAFÉ**  
DEMITASSE CUP  
TAZA DE CAFÉ  
11,5 CL - 3 OZ<sup>7/8</sup>

225352  
**SOUCOUPE À CAFÉ**  
DEMITASSE SAUCER  
PLATO CAFÉ  
12,5 CM - 4 IN<sup>15/16</sup>



230167  
**TASSE À THÉ**  
COFFEE / TEA CUP  
TAZA DE TÉ  
25 CL - 8 OZ<sup>7/8</sup>

230168  
**SOUCOUPE À THÉ**  
DEMITASSE / TEA SAUCER  
PLATO TÉ  
15 CM - 5 OZ<sup>7/8</sup>

KAOLIN - CAOLÍN



184088  
**ASSIETTE DE PRÉSENTATION**  
PRESENTATION PLATE, COUPE  
PLATO PRESENTACIÓN  
31,5 CM - 12 IN<sup>3/8</sup>

184077  
**ASSIETTE PLATE**  
DINNER PLATE, COUPE  
PLATO REDONDO  
28 CM - 11 IN

184078  
**ASSIETTE DESSERT**  
DESSERT SALAD PLATE, COUPE  
PLATO ILANO  
21 CM - 8 IN<sup>1/4</sup>



NEW

234449  
**COUPE RONDE**  
ROUND CUP  
BOL  
25 CM - 9 IN<sup>13/16</sup>



184079  
**ASSIETTE CALOTTE**  
SALAD CEREAL PLATE, COUPE  
PLATO HONDO  
21 CM - 8 IN<sup>1/4</sup>



209092  
**ASSIETTE À PAIN**  
BREAD & BUTTER PLATE, COUPE  
PLATO DE PAN  
16 CM - 6 IN<sup>5/16</sup>



184087  
**SALADIER**  
SALAD BOWL, DEEP  
ENSALADERA  
24 CM - 9 IN<sup>7/16</sup>  
H : 8 CM - 3 IN<sup>3/8</sup>

184086  
**COUPE/CALOTTE**  
SALAD / CEREAL PLATE, DEEP  
BOL  
17,7 CM - 6 IN<sup>15/16</sup>  
H : 5,5 CM - 2 IN<sup>3/16</sup>



184084  
**BOL À DÉJEUNER**  
SOUP / BREAKFAST BOWL  
BOL DESAYUNO  
14 CM - 5 IN<sup>1/2</sup>  
58 CL - 19 OZ<sup>5/8</sup>



184085  
**COUPELLE**  
SMALL BOWL, CUP  
BOL PEQUEÑO  
10 CM - 3 IN<sup>5/16</sup>  
H : 6 CM - 2 IN<sup>3/8</sup>



184083  
**MUG À THÉ**  
MUG  
TÈ MUG  
33 CL - 11 OZ<sup>3/8</sup>



184081  
**TASSE À CAFÉ**  
DEMITASSE CUP  
TAZA DE CAFÉ  
11,5 CL - 3 OZ<sup>7/8</sup>

184082  
**SOUCOUPE À CAFÉ**  
DEMITASSE SAUCER  
PLATO CAFÉ  
12,5 CM - 4 IN<sup>15/16</sup>



230163  
**TASSE À THÉ**  
COFFEE / TEA CUP  
TAZA DE TÉ  
25 CL - 8 OZ<sup>7/8</sup>

230164  
**SOUCOUPE À THÉ**  
DEMITASSE / TEA SAUCER  
PLATO TÉ  
15 CM - 5 OZ<sup>7/8</sup>

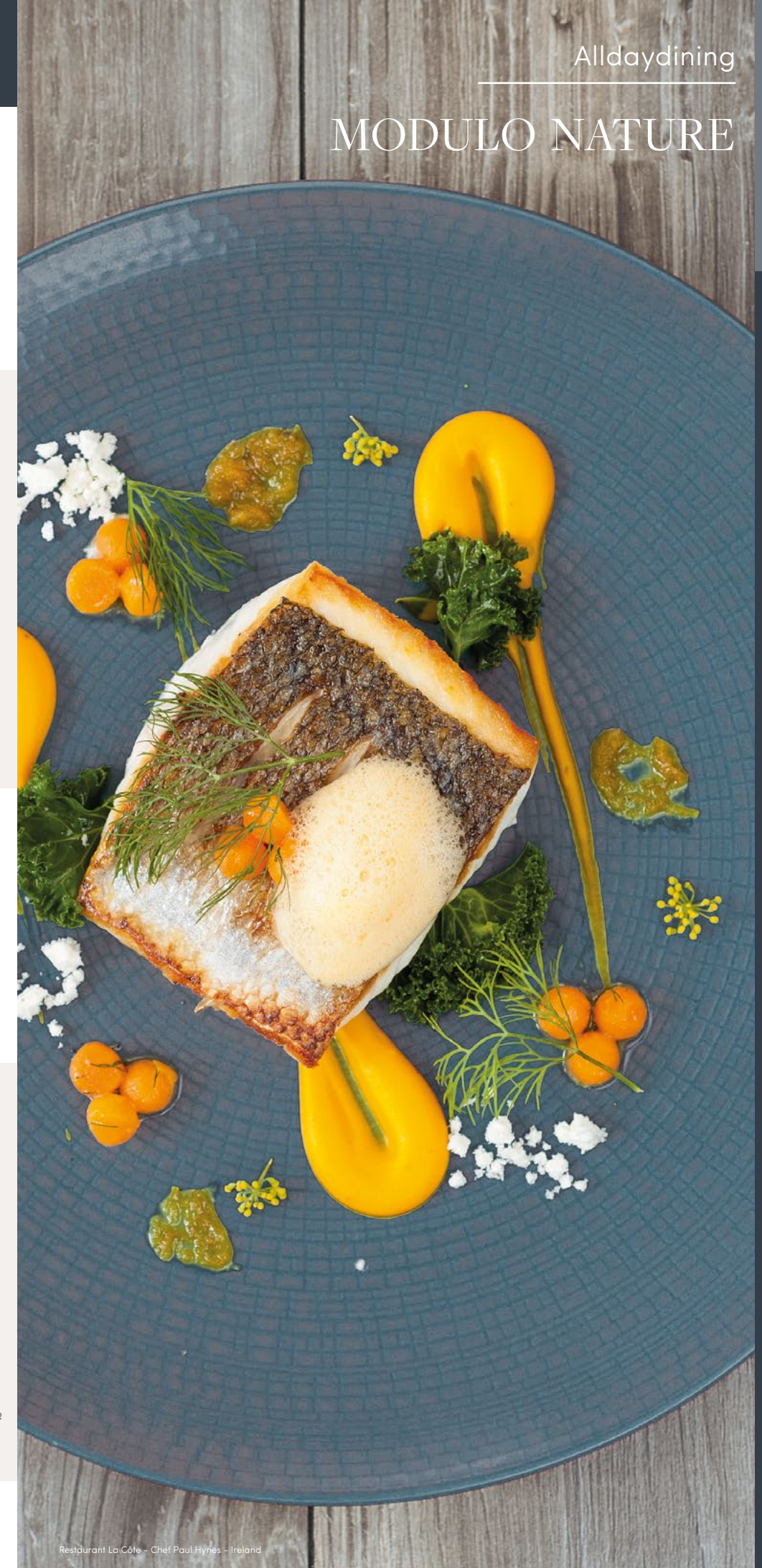

Restaurant La Côte - Chef Paul Hynes - Ireland



MODULO NATURE

TERRE D'OMBRE - TAUPE - TIERRA DE SOMBRA

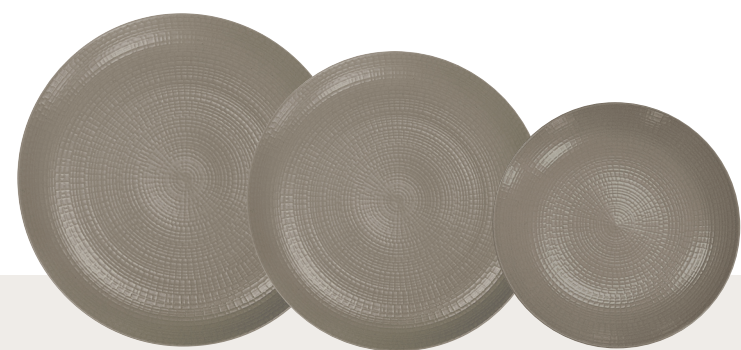

184101  
**ASSIETTE DE PRÉSENTATION**  
PRESENTATION PLATE, COUPE  
PLATO PRESENTACIÓN  
31,5 CM - 12 IN<sup>3/8</sup>

184090  
**ASSIETTE PLATE**  
DINNER PLATE, COUPE  
PLATO REDONDO  
28 CM - 11 IN

184091  
**ASSIETTE DESSERT**  
DESSERT SALAD PLATE, COUPE  
PLATO ILANO  
21 CM - 8 IN<sup>1/4</sup>



234451  
**COUPE RONDE**  
ROUND CUP  
BOL  
25 CM - 9 IN<sup>3/16</sup>

184092  
**ASSIETTE CALOTTE**  
SALAD CEREAL PLATE, COUPE  
PLATO HONDO  
21 CM - 8 IN<sup>1/4</sup>

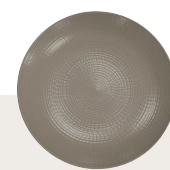

209093  
**ASSIETTE À PAIN**  
BREAD & BUTTER PLATE, COUPE  
PLATO DE PAN  
16 CM - 6 IN<sup>5/16</sup>

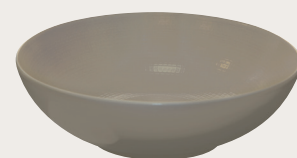

184100  
**SALADIER**  
SALAD BOWL, DEEP  
ENSALADERA  
24 CM - 9 IN<sup>7/16</sup>  
H : 8 CM - 3 IN<sup>3/16</sup>



184099  
**COUPE/CALOTTE**  
SALAD /CEREAL PLATE, DEEP  
BOL  
17,7 CM - 6 IN<sup>15/16</sup>  
H : 5,5 CM - 2 IN<sup>3/16</sup>



184097  
**BOL À DÉJEUNER**  
SOUP /BREAKFAST BOWL  
BOL DESAYUNO  
14 CM - 5 IN<sup>1/2</sup>  
58 CL - 19 OZ<sup>5/8</sup>



184098  
**COUPELLE**  
SMALL BOWL, CUP  
BOL PEQUEÑO  
10 CM - 3 IN<sup>9/16</sup>  
H : 6 CM - 2 IN<sup>3/8</sup>



184096  
**MUG À THÉ**  
MUG  
TÉ MUG  
33 CL - 11 OZ<sup>3/16</sup>



184094  
**TASSE À CAFÉ**  
DEMITASSE CUP  
TAZA DE CAFÉ  
11,5 CL - 3 OZ<sup>7/8</sup>

184095  
**SOUCOUPE À CAFÉ**  
DEMITASSE SAUCER  
ESPRESSO CAFÉ  
12,5 CM - 4 IN<sup>15/16</sup>



230165  
**TASSE À THÉ**  
TEA CUP  
TAZA DE TÉ  
25 CL - 6 OZ<sup>3/4</sup>

230166  
**SOUCOUPE À THÉ**  
DEMITASSE /TEA SAUCER  
PLATO TÉ  
15 CM - 5 OZ<sup>7/8</sup>

TOMETTE - RED - ROJO



205273  
**ASSIETTE DE PRÉSENTATION**  
PRESENTATION PLATE, COUPE  
PLATO PRESENTACIÓN  
31,5 CM - 12 IN<sup>3/8</sup>

205270  
**ASSIETTE PLATE**  
DINNER PLATE, COUPE  
PLATO REDONDO  
28 CM - 11 IN

205271  
**ASSIETTE DESSERT**  
DESSERT SALAD PLATE, COUPE  
PLATO ILANO  
21 CM - 8 IN<sup>1/4</sup>



205272  
**ASSIETTE CALOTTE**  
SALAD CEREAL PLATE, COUPE  
PLATO HONDO  
21 CM - 8 IN<sup>1/4</sup>

209094  
**ASSIETTE À PAIN**  
BREAD & BUTTER PLATE, COUPE  
PLATO DE PAN  
16 CM - 6 IN<sup>5/16</sup>



205276  
**SALADIER**  
SALAD BOWL, DEEP  
ENSALADERA  
24 CM - 9 IN<sup>7/16</sup>  
H : 8 CM - 3 IN<sup>3/16</sup>



205274  
**COUPE/CALOTTE**  
SALAD /CEREAL PLATE, DEEP  
BOL  
17,7 CM - 6 IN<sup>15/16</sup>  
H : 5,5 CM - 2 IN<sup>3/16</sup>



205275  
**COUPELLE**  
SMALL BOWL, CUP  
BOL PEQUEÑO  
10 CM - 3 IN<sup>9/16</sup>  
H : 6 CM - 2 IN<sup>3/8</sup>



222022  
**TASSE À CAFÉ**  
DEMITASSE CUP  
TAZA DE CAFÉ  
11,5 CL - 3 OZ<sup>7/8</sup>



222023  
**SOUCOUPE À CAFÉ**  
DEMITASSE SAUCER  
ESPRESSO CAFÉ  
12,5 CM - 4 IN<sup>15/16</sup>





VERT SHISHO - SHISHO GREEN - VERDE SHISHO



ROUGE PIMENT - RED CHILI - ROJO PIMIENTO



CRISTAUX DE SEL - SALT WHITE - CRISTALES DE SAL



BLEU INDIGO - INDIGO BLUE - AZUL AÑIL



**ASSIETTE À PARTAGER RONDE**

ROUND SHARED PLATE  
PLATO PARA COMPARTIR  
20 CM - 7 IN<sup>7/8</sup>

**ASSIETTE PLATE RONDE**

ROUND DINNER PLATE  
PLATO REDONDO  
26 CM - 10 IN<sup>1/4</sup>

**COUPELLE RONDE**

ROUND SMALL BOWL  
BOL PEQUEÑO  
12,5 CM - 4 IN<sup>15/16</sup>  
33 CL - 11 OZ<sup>3/16</sup>

**GRANDES ASSIETTES CREUSES RONDDES**

ROUND LARGE DEEP PLATES  
GRANDE PLATO REDONDO  
22,5 CM - 8 IN<sup>7/8</sup>  
1L - 33 OZ<sup>13/16</sup>

24 CM - 9 IN<sup>7/16</sup>  
1,25L - 42 OZ<sup>1/4</sup>

**BOL**

BOWL  
BOL  
19 CM - 7 IN<sup>1/2</sup>  
1,1 L - 37 OZ<sup>3/16</sup>



Alldaydining  
**NEW MONDO**

LA VAISSELLE  
TABLEWARE - VAJILLA



# NEWMOON



207126  
**ASSIETTE PLATE**  
PRESENTATION PLATE  
PLATO PRESENTACIÓN  
32 CM - 12 IN<sup>5/8</sup>



207125  
**ASSIETTE PLATE**  
DINNER PLATE  
PLATO  
28 CM - 11 IN



207127  
**ASSIETTE DESSERT**  
DESSERT/SALAD/APP. PLATE  
PLATO  
24 CM - 9 IN<sup>7/16</sup>



207124  
**ASSIETTE À PAIN**  
BREAD & BUTTER PLATE  
PLATO  
16 CM - 6 IN<sup>5/16</sup>



198047  
**SALADIER/BOL**  
DEEP BOWL, SOUP/SALAD  
ENSALADERA  
20 CM - 7 IN<sup>7/8</sup>



© Patrick FOUGEREAU

L'ABUS D'ALCOOL EST DANGEREUX POUR LA SANTÉ  
DEGRENNÉ PROMOTES RESPONSIBLE DRINKING AND DISCOURAGES ALCOHOL MISUSE  
EL ABUSO DE ALCOHOL ES PELIGROSO PARA LA SALUD







161009  
**ASSIETTE PLATE**  
PRESENTATION PLATE  
PLATO PRESENTACIÓN  
28 CM - 11 IN



**NEW**  
161008  
**ASSIETTE PLATE**  
DINNER PLATE  
PLATO  
24 CM - 9 IN<sup>5/16</sup>



161038  
**ASSIETTE PLATE**  
BREAD & BUTTER PLATE  
PLATO REDONDO  
16 CM - 6 IN<sup>5/16</sup>



161012  
**ASSIETTE CREUSE**  
SHALLOW COUPE BOWL, LARGE  
PLATO HONDO  
30 CM - 11 IN<sup>13/16</sup>



161011  
**ASSIETTE CREUSE**  
SHALLOW COUPE BOWL, MEDIUM  
PLATO HONDO  
23 CM - 9 IN<sup>1/16</sup>



161016  
**SALADIER**  
DEEP BOWL, LARGE  
ENSALADERA  
32 CM - 12 IN<sup>5/8</sup>  
CONTENANCE : 250 CL  
CAPACITY : 84 OZ<sup>3/16</sup>  
H : 14 CM - 5 IN<sup>1/2</sup>



161015  
**SALADIER**  
DEEP BOWL, MEDIUM  
ENSALADERA  
25 CM - 9 IN<sup>13/16</sup>  
CONTENANCE : 150 CL  
CAPACITY : 50 OZ<sup>3/4</sup>  
H : 11,5 CM - 4 IN<sup>1/4</sup>



161014  
**SALADIER/BOL**  
DEEP BOWL, INDIVIDUAL  
BOL  
16,5 CM - 6 IN<sup>1/2</sup>  
CONTENANCE : 50 CL  
CAPACITY : 16 OZ<sup>15/16</sup>  
H : 9 CM - 3 IN<sup>5/16</sup>



161013  
**SALADIER/BOL**  
DEEP BOWL, CUP  
BOL  
9 CM - 3 IN<sup>9/16</sup>  
CONTENANCE : 20 CL  
CAPACITY : 6 OZ<sup>3/4</sup>  
H : 7 CM - 2 IN<sup>9/16</sup>



161020  
**COQUETIER**  
EGG CUP, PLATE  
HUEVERA  
15 CM - 5 IN<sup>7/8</sup>



161037  
**RAVIER**  
SHALLOW RAMEKIN, COUPE  
BOL  
10 CM - 3 IN<sup>15/16</sup>  
H : 4 CM - 1 IN<sup>3/8</sup>



161036  
**SUPPORT PLATEAU**  
TRAY STAND, 3 PLACES  
FUENTE CON 3 ESPACIOS  
30,5 X 10 CM - 12 IN X 3 IN<sup>5/16</sup>



198017  
**POT À SAUCE/GARNITURE**  
RAMEKIN, LARGE  
POT  
48 CL - 16 OZ<sup>1/4</sup>  
Ø 10,5 CM - 4 IN<sup>1/8</sup>  
H : 8 CM - 2 IN<sup>1/16</sup>



198016  
**POT À SAUCE/GARNITURE**  
RAMEKIN, SMALL  
POT  
20 CL - 6 OZ<sup>3/4</sup>  
Ø 8 CM - 3 IN<sup>1/8</sup>  
H : 7 CM - 2 IN<sup>9/16</sup>



196561  
**POT À SAUCE/GARNITURE**  
RAMEKIN, SMALL  
POT  
7,5 CL - 2 OZ<sup>3/16</sup>  
Ø 5,5 CM - 2 IN<sup>3/16</sup>  
H : 6,5 CM - 2 IN<sup>9/16</sup>



214688  
**SOUCOUBE UNIVERSELLE**  
UNIVERSAL SAUCER CUP  
PLATO UNIVERSAL  
13 CM - 5 IN<sup>1/8</sup>



207766  
**TASSE À ESPRESSO**  
ESPRESSO CUP  
ESPRESSO DE TAZA  
6 CL - 2 OZ



161025  
**SOUCOUBE À CAFÉ/ESPRESSO**  
DEMITASSE/ESPRESSO SAUCER  
ESPRESSO DE PLATO  
15 CM - 5 IN<sup>7/8</sup>



208948  
**TASSE À CAFÉ**  
DEMITASSE CUP  
TAZA DE CAFÉ  
11 CL - 3 OZ<sup>3/4</sup>



207767  
**TASSE À THÉ/LUNGO**  
COFFEE/TEA CUP  
LUNGO DE TAZA  
20 CL - 6 OZ<sup>3/4</sup>



161028  
**SOUCOUBE À THÉ/LUNGO**  
COFFEE/TEA SAUCER  
LUNGO DE PLATO  
18 CM - 7 IN<sup>1/16</sup>



207768  
**TASSE À DÉJEUNER**  
BREAKFAST CUP  
TAZA DESAYUNO  
48 CL - 16 OZ<sup>1/4</sup>



161034  
**SOUCOUBE À DÉJEUNER**  
BREAKFAST SAUCER  
PLATO DESAYUNO  
21 CM - 8 IN<sup>1/4</sup>



207765  
**MUG**  
MUG, LARGE  
MUG  
50 CL - 16 OZ<sup>15/16</sup>



209189  
**MUG**  
MUG  
MUG  
30 CL - 10 OZ<sup>1/8</sup>



BLANC ROND - ROUND WHITE - BLANCO REDONDO



- 207120 **ASSIETTE DE PRÉSENTATION**  
PRESENTATION COUPE PLATE  
PLATO PRESENTACIÓN  
32 CM - 12 IN<sup>5/8</sup>
- 207112 **ASSIETTE PLATE**  
DINNER COUPE PLATE  
PLATO REDONDO  
29 CM - 11 IN<sup>7/16</sup>
- 207113 **ASSIETTE PLATE**  
DINNER COUPE PLATE  
PLATO REDONDO  
26 CM - 10 IN<sup>1/4</sup>
- 207111 **ASSIETTE DESSERT**  
DESSERT/SALAD/APP.COUCHE PLATE  
PLATO REDONDO  
20 CM - 7 IN<sup>7/8</sup>
- 207119 **ASSIETTE À PAIN**  
BREAD & BUTTER COUCHE PLATE  
PLATO DE PAN  
15 CM - 5 IN<sup>7/8</sup>
- 188537 **BOL À SOUPE**  
MED BOWL, SOUP  
BOL HONDO  
13 CM - 5 IN<sup>1/8</sup>  
H : 6 CM - 2 IN<sup>3/8</sup>
- 207114 **ASSIETTE CREUSE/CALOTTE**  
ROUND SHALLOW BOWL  
PLATO HONDO  
20 CM - 7 IN<sup>7/8</sup>



- 142722 **BOL**  
DEEP BOWL, LARGE  
BOL HONDO  
28 CM - 11 IN  
CONTENANCE : 2,5 L  
CAPACITY : 84 OZ<sup>5/8</sup>  
H : 12 CM - 4 IN<sup>3/4</sup>
- 136529 **BOL**  
DEEP BOWL, MEDIUM  
BOL HONDO  
24 CM - 9 IN<sup>7/16</sup>  
CONTENANCE : 2 L  
CAPACITY : 67 OZ<sup>5/8</sup>  
H : 11 CM - 4 IN<sup>1/4</sup>
- 136511 **BOL**  
DEEP BOWL, MEDIUM  
BOL HONDO  
20 CM - 7 IN<sup>7/8</sup>  
CONTENANCE : 1,30 L  
CAPACITY : 43 OZ<sup>5/16</sup>  
H : 9,5 CM - 3 IN<sup>3/4</sup>
- 136528 **BOL**  
DEEP BOWL, INDIVIDUAL  
BOL HONDO  
16 CM - 6 IN<sup>5/16</sup>  
CONTENANCE : 67 CL  
CAPACITY : 22 OZ<sup>5/16</sup>  
H : 7,5 CM - 2 IN<sup>15/16</sup>
- 154245 **BOL**  
DEEP BOWL, SOUP  
BOL HONDO  
14 CM - 5 IN<sup>1/2</sup>  
CONTENANCE : 55 CL  
CAPACITY : 18 OZ<sup>5/8</sup>  
H : 8 CM - 2 IN<sup>11/16</sup>
- 136510 **BOL**  
DEEP BOWL, RICE  
BOL HONDO  
12 CM - 4 IN<sup>3/4</sup>  
CONTENANCE : 27 CL  
CAPACITY : 9 OZ<sup>2/8</sup>  
H : 5,5 CM - 2 IN<sup>3/16</sup>
- 136509 **BOL**  
DEEP BOWL, RAMEKIN  
BOL HONDO  
8 CM - 3 IN<sup>1/8</sup>  
CONTENANCE : 8 CL  
CAPACITY : 3 OZ<sup>2/8</sup>  
H : 4,5 CM - 1 IN<sup>3/4</sup>



- 136535 **COUPE**  
PASTA/SALAD/SEAFOOD BOWL,  
FOOTED  
BOL  
24 CM - 9 IN<sup>7/16</sup>  
H : 11 CM - 4 IN<sup>1/4</sup>
- 136532 **COUPE**  
SHALLOW BOWL, FOOTED  
BOL  
16 CM - 6 IN<sup>5/16</sup>  
H : 7,5 CM - 2 IN<sup>15/16</sup>
- 136530 **COUPE**  
SHALLOW BOWL, FOOTED  
BOL  
8 CM - 3 IN<sup>1/8</sup>  
H : 2,5 CM - 1 IN

GRIS PERLE - LIGHT GREY - GRIS PERLA



- 230142 **BOL**  
DEEP BOWL, MEDIUM  
BOL HONDO  
24 CM - 9 IN<sup>7/16</sup>  
CONTENANCE : 2 L  
CAPACITY : 67 OZ<sup>5/8</sup>  
H : 11 CM - 4 IN<sup>1/4</sup>
- 230141 **BOL**  
DEEP BOWL, MEDIUM  
BOL HONDO  
20 CM - 7 IN<sup>7/8</sup>  
CONTENANCE : 1,30 L  
CAPACITY : 43 OZ<sup>5/16</sup>  
H : 9,5 CM - 3 IN<sup>3/4</sup>
- 230140 **BOL**  
DEEP BOWL, INDIVIDUAL  
BOL HONDO  
16 CM - 6 IN<sup>5/16</sup>  
CONTENANCE : 67 CL  
CAPACITY : 22 OZ<sup>5/16</sup>  
H : 7,5 CM - 2 IN<sup>15/16</sup>
- 230139 **BOL À DÉJEUNER**  
SOUP/BREAKFAST BOWL  
BOL DESAYUNO  
14 CM - 5 IN<sup>1/2</sup>  
CONTENANCE : 55 CL  
CAPACITY : 18 OZ<sup>5/8</sup>  
H : 8 CM - 2 IN<sup>11/16</sup>
- 230138 **BOL À THÉ**  
TEA BOWL, RAMEKIN  
BOL HONDO  
9 CM - 3 IN<sup>9/16</sup>  
CONTENANCE : 20 CL  
CAPACITY : 6 OZ<sup>3/4</sup>  
H : 4,5 CM - 1 IN<sup>3/4</sup>





CARRÉE - SQUARE PLATE - PLATO CUADRADO



207118  
**ASSIETTE DE PRÉSENTATION**  
PRESENTATION COUPE PLATE  
PLATO PRESENTACIÓN  
28 CM - 11 IN



207115  
**ASSIETTE PLATE**  
DINNER COUPE PLATE  
PLATO  
24 CM - 9 IN<sup>7/16</sup>



207117  
**ASSIETTE DESSERT**  
DESSERT/SALAD/APP. COUPE PLATE  
PLATO  
20 CM - 7 IN<sup>7/8</sup>



207123  
**ASSIETTE À PAIN**  
BREAD & BUTTER COUPE PLATE  
PLATO DE PAN  
14 CM - 5 IN<sup>1/2</sup>

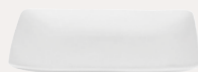

207116  
**ASSIETTE CREUSE**  
SOUP/SALAD, COUPE PLATE  
PLATO HONDO CUADRADO  
20 CM - 7 IN<sup>7/8</sup>



149831  
**PLAT CREUX**  
SQUARE DEEP DISH, COUPE  
PLATO HONDO  
28 CM - 11 IN  
H : 5,5 CM - 2 IN<sup>3/16</sup>



154244  
**PLAT CREUX**  
SQUARE DEEP DISH, COUPE  
PLATO HONDO  
16 CM - 6 IN<sup>5/16</sup>  
H : 6 CM - 2 IN<sup>3/8</sup>



136502  
**COUPE**  
SQUARE BOWL, FOOTED COUPE  
BOL  
12 CM - 4 IN<sup>3/4</sup>  
H : 3,5 CM - 1 IN<sup>3/8</sup>



136503  
**COUPE**  
SQUARE BOWL, FOOTED COUPE  
BOL  
8 CM - 3 IN<sup>1/8</sup>  
H : 2,5 CM - 1 IN



181483  
**BOL CARRÉ**  
SQUARE BOWL, DEEP  
BOL HONDO  
12 CM - 4 IN<sup>3/4</sup>  
H : 3,5 CM - 1 IN<sup>3/8</sup>

RECTANGULAIRE - RECTANGULAR PLATE - PLATO RECTANGULAR



181485  
**ASSIETTE PLATE**  
PRESENTATION COUPE PLATE  
PLATO RECTANGULAR  
34X26 CM - 13 IN<sup>3/8</sup> X 10 IN<sup>1/4</sup>



207122  
**ASSIETTE PLATE**  
DINNER COUPE PLATE  
PLATO RECTANGULAR  
30X22 CM - 11 IN<sup>13/16</sup> X 8 IN<sup>1/16</sup>



207110  
**ASSIETTE DESSERT**  
DESSERT/SALAD/APP COUPE PLATE  
PLATO RECTANGULAR  
26X18 CM - 10 IN<sup>1/4</sup> X 7 IN<sup>1/16</sup>

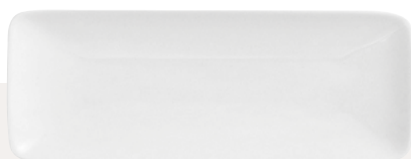

207754  
**PLAT RECTANGULAIRE**  
RECTANGULAR DISH, COUPE LARGE  
PLATO RECTANGULAR  
40X16 CM - 15 IN<sup>3/4</sup> X 6 IN<sup>5/16</sup>



207753  
**PLAT RECTANGULAIRE**  
RECTANGULAR DISH, COUPE LARGE  
PLATO RECTANGULAR  
20X12 CM - 7 IN<sup>7/8</sup> X 4 IN<sup>3/4</sup>

ACCESSOIRES - ACCESSORIES - ACCESORIOS



209382  
**PRÉSENTOIR À GÂTEAUX**  
ROUND APP/PIZZA/PRESENTATION STAND  
EXPOSITOR DE TARTAS  
32 CM - 12 IN<sup>5/16</sup>  
H : 10,5 CM - 4 IN<sup>1/4</sup>



209381  
**PRÉSENTOIR À GÂTEAUX**  
ROUND APP/PIZZA/PRESENTATION STAND  
EXPOSITOR DE TARTAS  
25 CM - 9 IN<sup>13/16</sup>  
H : 8,5 CM - 2 IN<sup>3/16</sup>



136524  
**PLAT À TARTE**  
PIE/PIZZA PLATE, FLAT  
FUENTE PARA PASTEL  
32 CM - 12 IN<sup>5/8</sup>



181490  
**VERRINE PORCELAIN**  
RAMEKIN  
VASITO PORCELANA  
8 CL - 2 OZ<sup>1/16</sup>



182915  
**COFFRET SALIÈRE/POIVRIÈRE**  
SALT & PEPPER CRUET  
SALERO Y PIMENTERO

NEWCOOK MODULO



162015  
**RAMEQUIN**  
RAMEKIN  
RAMEKIN  
9,5 CM - 3 IN<sup>3/4</sup>



162013  
**BOL À CONSOMÉ**  
SOUP BOWL  
BOL CONSOMÉ  
10,5 CM - 4 IN<sup>9/16</sup>  
50 CL - 16 OZ<sup>15/16</sup>



162011  
**ASSIETTE À CRÈME BRÛLÉE**  
«CRÈME BRÛLÉE» DISH  
PLATO PARA GRATINAR  
14 CM - 5 IN<sup>1/2</sup>



164138  
**PLAT À ESCARGOTS 6 PLACES**  
SNAIL TRAY 6 SPACES  
BANDEJA CARACOLAS 6 COMPARTIMENTOS  
16,6 X 11,2 CM - 6 IN<sup>9/16</sup> X 4 IN<sup>7/16</sup>







207131  
**ASSIETTE PLATE RECTANGLE  
6 COMPARTIMENTS**  
RECTANGULAR DINNER PLATE  
6 COMPARTMENTS  
PLATO RECTANGULAR/6 COMPARTIMENTOS  
27X18 CM - 10 IN<sup>5/8</sup> X 7 IN<sup>1/2</sup>

207133  
**SOUCOUPE RECTANGULAIRE**  
RECTANGULAR PLATE/ SAUCER  
PLATO RECTANGULAR  
27X9 CM - 10 IN<sup>5/8</sup> X 3 IN<sup>9/16</sup>



©Patrick ROUGEREAU





234605  
**ASSIETTE DE PRÉSENTATION**  
PRESENTATION PLATE  
PLATO PRESENTACIÓN  
32 CM - 12 IN<sup>5/8</sup>



234612  
**ASSIETTE DE PRÉSENTATION**  
PRESENTATION PLATE  
PLATO PRESENTACIÓN  
30 CM - 11 IN<sup>13/16</sup>



234607  
**ASSIETTE PLATE**  
DINNER PLATE  
PLATO REDONDO  
26,5 CM - 10 IN<sup>7/16</sup>



234608  
**ASSIETTE DESSERT**  
DESSERT PLATE  
PLATO ILANO  
21,5 CM - 8 IN<sup>7/16</sup>



234611  
**ASSIETTE DESSERT**  
DESSERT PLATE  
PLATO ILANO  
18,5 CM - 7 IN<sup>5/16</sup>

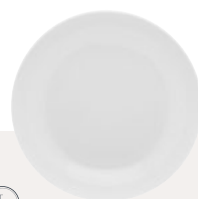

234609  
**ASSIETTE CREUSE CALOTTE**  
CEREAL PLATE  
PLATO HONDO  
19 CM - 7 IN<sup>1/2</sup>

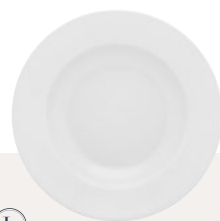

234610  
**ASSIETTE CREUSE BORD À AILE**  
ROUND DEEP PLATE  
PLATO HONDO  
22,5 CM - 8 IN<sup>7/16</sup>



234603  
**ASSIETTE À PAIN**  
BREAD PLATE  
PLATO DE PAN  
16 CM - 6 IN<sup>5/16</sup>



234604  
**BOL À SALADE AVEC AILE**  
SALAD BOWL WITH RIM  
BOL DE ENSALADA CON ALETA  
17,5 CM - 6 IN<sup>7/16</sup>



234606  
**PLAT OVALE**  
OVAL DISH  
FUENTE OVALADO  
36,5 X 26,5 CM - 14 IN<sup>3/8</sup> X 10 IN<sup>7/16</sup>



L'ABUS D'ALCOOL EST DANGEREUX POUR LA SANTÉ  
DEGRENE PROMOTES RESPONSIBLE DRINKING AND DISCOURAGES ALCOHOL MISUSE  
EL ABUSO DE ALCOHOL ES PELIGROSO PARA LA SALUD



PORCELAIN BLANCHE - WHITE PORCELAIN - PORCELANA BLANCO



216529  
**ASSIETTE ULTRA PLATE RONDE**  
ROUND ULTRA PLATE  
PLATO SÚPER PLANO  
25 CM - 9 IN<sup>3/16</sup>



216531  
**ASSIETTE ULTRA PLATE RONDE**  
ROUND ULTRA PLATE  
PLATO SÚPER PLANO  
12 CM - 4 IN<sup>3/4</sup>



216536  
**ASSIETTE À CRÈME BRÛLÉE**  
«CRÈME BRÛLÉE» ROUND PLATE  
PLATO PARA GRATINAR  
13,5 CM - 5 IN<sup>5/16</sup>



216532  
**ASSIETTE OBLONGUE**  
OBLONG PLATE  
PLATO OBLANGA  
32 X 19 CM - 12 IN<sup>5/8</sup> X 7 IN<sup>1/2</sup>



216530  
**ASSIETTE À SALADE RONDE AVEC PIED**  
FOOTED ROUND DEEP PLATE  
PLATO DE ENSALADA CON PIE  
20 CM - 7 IN<sup>7/8</sup>



216535  
**COUPELLE RONDE AVEC PIED**  
FOOTED ROUND DEEP PLATE  
BOL PEQUEÑO CON PIE  
14 CM - 5 IN<sup>1/2</sup>



216534  
**COUPELLE RONDE AVEC PIED**  
FOOTED ROUND DEEP PLATE  
BOL PEQUEÑO CON PIE  
12 CM - 4 IN<sup>3/4</sup>

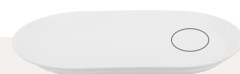

216533  
**ASSIETTE OBLONGUE**  
OBLONG PLATE  
PLATO OBLANGA  
20 X 12 CM - 7 IN<sup>7/8</sup> X 4 IN<sup>3/4</sup>

GRÈS GRIS - GRES STONEWARE - ARENISCA



198935  
**PLAT À GRATIN ROND**  
ROUND CASSEROLE PLATE  
PLATO PARA GRATINAR  
14 CM - 5 IN<sup>1/2</sup>



198939  
**BOL À CONSOMÉ**  
SOUP BOWL  
BOL CONSOMÉ  
13 CM - 5 IN<sup>1/8</sup>



198936  
**GOBELET ROND**  
ROUND TUMBLER  
VASO REDONDO  
9 CM - 3 IN<sup>9/16</sup>

**EMPILABLE**  
STACKABLE  
APILABLE







---

## REVISITER UNE ICÔNE

---

Créée en 1953, la théière Salam est le produit emblématique de la marque DEGRENNE. La finesse de la porcelaine alliée à l'éclat de la cloche sublime l'instant thé. Grâce à sa cloche tapissée d'une feutrine, **le thé conserve une température optimale deux fois plus longtemps que dans une théière classique.** Un procédé astucieux qui permet au thé de déployer toute la subtilité de ses saveurs au fil de la dégustation.

---

### REVISIT AN ICON

---

Created in 1953, Salam teapot is the iconic product of DEGRENNE. The finesse of porcelain combined with the radiance of the outer body enhances the tea experience. With its inner lining of thin felt, **the tea inside is kept at its optimum temperature for twice as long as in a regular teapot.** This is a clever trick to ensure that the tea is infused with all the subtlety of its flavours as the tasting progresses.

---

### VOLVER A EXPLORAR UN ICONO

---

Creada en 1953, la tetera Salam es el producto emblemático de la marca DEGRENNE. La finura de la porcelana combinada con el brillo del cuerpo de la tetera sublima el instante del té. Gracias a su cuerpo tapizado con fieltro, **el té conserva una temperatura óptima el doble de tiempo que una tetera clásica.** Este ingenioso proceso permite que el té despliegue toda la sutilidad de sus aromas a lo largo de la degustación.



# SALAM

## SALAM BLANCHE - WHITE - BLANCO



- 211990 THÉIÈRE 8 TASSES**  
TEA POT 8 CUPS  
TETERA 8 TAZAS  
130 CL - 43 OZ<sup>15/16</sup>
- 211989 THÉIÈRE 6 TASSES**  
TEA POT 6 CUPS  
TETERA 6 TAZAS  
100 CL - 33 OZ<sup>13/16</sup>
- 211988 THÉIÈRE 4 TASSES**  
TEA POT 4 CUPS  
TETERA 4 TAZAS  
70 CL - 23 OZ<sup>11/16</sup>
- 211987 THÉIÈRE 2 TASSES**  
TEA POT 2 CUPS  
TETERA 2 TAZAS  
35 CL - 11 OZ<sup>13/16</sup>

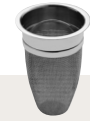

**INFUSEUR**  
STAINLESS STEEL FILTER  
FILTRO TETERA

147992  
2 TASSES  
2 CUPS - 2 TAZAS

147994  
4 TASSES  
4 CUPS - 4 TAZAS

147993  
6/8 TASSES  
6/8 CUPS  
6/8 TAZAS

**FEUTRE NOIR ISOLANT POUR THÉIÈRE**  
BLACK TEA POT FELT FILTER NEGRO AISLANTE TETERA

217130 - 2 TASSES  
2 CUPS - 2 TAZAS

217131 - 4 TASSES  
4 CUPS - 4 TAZAS

217132 - 6 TASSES  
6 CUPS - 6 TAZAS

217133 - 8 TASSES  
8 CUPS - 8 TAZAS



**205135 BOUCHON PORCELAINE THÉIÈRE - 2/4 TASSES**  
PORCELAIN LID FOR TEA POT - 2/4 CUPS  
TAPA DE PORCELANA TETERA - 2/4 TAZAS



**205136 BOUCHON PORCELAINE THÉIÈRE - 6/8 TASSES**  
PORCELAIN LID FOR TEA POT - 6/8 CUPS  
TAPA DE PORCELANA TETERA - 6/8 TAZAS



- 189949 CORPS THÉIÈRE 8 TASSES**  
TEA POT 8 CUPS WITHOUT LID  
CUERPO TETERA 8 TAZAS
- 189948 CORPS THÉIÈRE 6 TASSES**  
TEA POT 6 CUPS WITHOUT LID  
CUERPO TETERA 6 TAZAS
- 189947 CORPS THÉIÈRE 4 TASSES**  
TEA POT 4 CUPS WITHOUT LID  
CUERPO TETERA 4 TAZAS
- 189946 CORPS THÉIÈRE 2 TASSES**  
TEA POT 2 CUPS WITHOUT LID  
CUERPO TETERA 2 TAZAS

## SALAM NOIRE - BLACK - NEGRO



- 211994 THÉIÈRE 8 TASSES**  
TEA POT 8 CUPS  
TETERA 8 TAZAS  
130 CL - 43 OZ<sup>15/16</sup>
- 211993 THÉIÈRE 6 TASSES**  
TEA POT 6 CUPS  
TETERA 6 TAZAS  
100 CL - 33 OZ<sup>13/16</sup>
- 216414 THÉIÈRE 6 TASSES**  
TEA POT 6 CUPS  
TETERA 6 TAZAS  
100 CL - 33 OZ<sup>13/16</sup>
- 211992 THÉIÈRE 4 TASSES**  
TEA POT 4 CUPS  
TETERA 4 TAZAS  
70 CL - 23 OZ<sup>11/16</sup>
- 216410 THÉIÈRE 4 TASSES**  
TEA POT 4 CUPS  
TETERA 4 TAZAS  
70 CL - 23 OZ<sup>11/16</sup>
- 211991 THÉIÈRE 2 TASSES**  
TEA POT 2 CUPS  
TETERA 2 TAZAS  
35 CL - 11 OZ<sup>13/16</sup>



**210575 BOUCHON PORCELAINE THÉIÈRE - 2/4 TASSES**  
PORCELAIN LID FOR TEA POT - 2/4 CUPS  
TAPA DE PORCELANA TETERA - 2/4 TAZAS



- 150447 CORPS THÉIÈRE 8 TASSES**  
TEA POT 8 CUPS WITHOUT LID  
CUERPO TETERA 8 TAZAS
- 150456 CORPS THÉIÈRE 6 TASSES**  
TEA POT 6 CUPS WITHOUT LID  
CUERPO TETERA 6 TAZAS



**150455 CORPS THÉIÈRE 4 TASSES**  
TEA POT 4 CUPS WITHOUT LID  
CUERPO TETERA 4 TAZAS



**150450 CORPS THÉIÈRE 2 TASSES**  
TEA POT 2 CUPS WITHOUT LID  
CUERPO TETERA 2 TAZAS



**210576 BOUCHON PORCELAINE THÉIÈRE - 6/8 TASSES**  
PORCELAIN LID FOR TEA POT - 6/8 CUPS  
TAPA DE PORCELANA TETERA - 6/8 TAZAS

## SALAM COLOR

**CLOCHE ALUMINIUM ZINC**  
ZINC ALUMINIUM LID  
CAMPANA ZINC ALUMINIO



- 216416 THÉIÈRE 6 TASSES**  
TEA POT 6 CUPS  
TETERA 6 TAZAS  
100 CL - 33 OZ<sup>13/16</sup>
- 216412 THÉIÈRE 4 TASSES**  
TEA POT 4 CUPS  
TETERA 4 TAZAS  
70 CL - 23 OZ<sup>11/16</sup>

**CLOCHE ALUMINIUM BRONZE**  
BRONZE ALUMINIUM LID  
CAMPANA BRONCE ALUMINIO



- 216415 THÉIÈRE 6 TASSES**  
TEA POT 6 CUPS  
TETERA 6 TAZAS  
100 CL - 33 OZ<sup>13/16</sup>
- 216411 THÉIÈRE 4 TASSES**  
TEA POT 4 CUPS  
TETERA 4 TAZAS  
70 CL - 23 OZ<sup>11/16</sup>

**CLOCHE ALUMINIUM BLEUE**  
BLUE ALUMINIUM LID  
CAMPANA AZUL ALUMINIO



- 225359 THÉIÈRE 6 TASSES**  
TEA POT 6 CUPS  
TETERA 6 TAZAS  
100 CL - 33 OZ<sup>13/16</sup>
- 225358 THÉIÈRE 4 TASSES**  
TEA POT 4 CUPS  
TETERA 4 TAZAS  
70 CL - 23 OZ<sup>11/16</sup>

**CLOCHE INOX DORÉ**  
GOLD STAINLESS STEEL LID  
CAMPANA DORADO INOX



- 234217 THÉIÈRE 6 TASSES**  
TEA POT 6 CUPS  
TETERA 6 TAZAS  
100 CL - 33 OZ<sup>13/16</sup>
- 234216 THÉIÈRE 4 TASSES**  
TEA POT 4 CUPS  
TETERA 4 TAZAS  
70 CL - 23 OZ<sup>11/16</sup>





BLANC - WHITE - BLANCO



210946  
**TASSE À CAFÉ**  
DEMITASSE CUP  
TAZA DE CAFÉ  
11 CL - 3 OZ<sup>3/4</sup>



210947  
**TASSE À THÉ**  
COFFÉE/TEA CUP  
TAZA DE TÉ  
25 CL - 8 OZ<sup>7/16</sup>



210948  
**TASSE DÉJEUNER**  
BREAKFAST CUP  
TAZA DESAYUNO  
42 CL - 14 OZ<sup>3/16</sup>



210949  
**MUG À THÉ**  
TEA MUG  
MUG  
38 CL - 12 OZ<sup>7/16</sup>



210950  
**SOUCOUBE CAFÉ/THÉ**  
DEMITASSE/COFFÉE/TEA SAUCER  
PLATO CAFÉ/TÉ  
16 CM - 6 IN<sup>5/16</sup>

GRIS PERLE - LIGHT GREY - GRIS PERLA



230145  
**TASSE À CAFÉ**  
DEMITASSE CUP  
TAZA DE CAFÉ  
11 CL - 3 OZ<sup>3/4</sup>



230146  
**TASSE À THÉ**  
COFFÉE/TEA CUP  
TAZA DE TÉ  
25 CL - 8 OZ<sup>7/16</sup>



230147  
**TASSE DÉJEUNER**  
BREAKFAST CUP  
TAZA DESAYUNO  
42 CL - 14 OZ<sup>3/16</sup>



230148  
**MUG À THÉ**  
TEA MUG  
MUG  
38 CL - 12 OZ<sup>7/16</sup>



210951  
**SOUCOUBE DÉJEUNER/MUG**  
BREAKFAST/MUG SAUCER  
PLATO DESAYUNO/MUG  
18 CM - 7 IN<sup>7/16</sup>

ROSE POUDRÉ - POWDER PINK - POLVO ROSA



230130  
**TASSE À CAFÉ**  
DEMITASSE CUP  
TAZA DE CAFÉ  
11 CL - 3 OZ<sup>3/4</sup>



230131  
**TASSE À THÉ**  
COFFÉE/TEA CUP  
TAZA DE TÉ  
25 CL - 8 OZ<sup>7/16</sup>



230132  
**TASSE DÉJEUNER**  
BREAKFAST CUP  
TAZA DESAYUNO  
42 CL - 14 OZ<sup>3/16</sup>



230133  
**MUG À THÉ**  
TEA MUG  
MUG  
38 CL - 12 OZ<sup>7/16</sup>



187276  
**SUCRIER**  
SUGAR BOWL  
AZUCARERO CON TAPA  
28 CL - 9 OZ<sup>7/16</sup>



150475  
**SUCRIER**  
SUGAR BOWL  
AZUCARERO CON TAPA  
28 CL - 9 OZ<sup>7/16</sup>



187283  
**CORPS SUCRIER**  
SUGAR BOWL WITHOUT LID  
AZUCARERO



150469  
**CORPS SUCRIER**  
SUGAR BOWL WITHOUT LID  
AZUCARERO



187277  
**CRÉMIER**  
CREAMER, JUG  
LECHERA  
15 CL - 5 OZ<sup>1/16</sup>



150485  
**CRÉMIER**  
CREAMER, JUG  
LECHERA  
15 CL - 5 OZ<sup>1/16</sup>





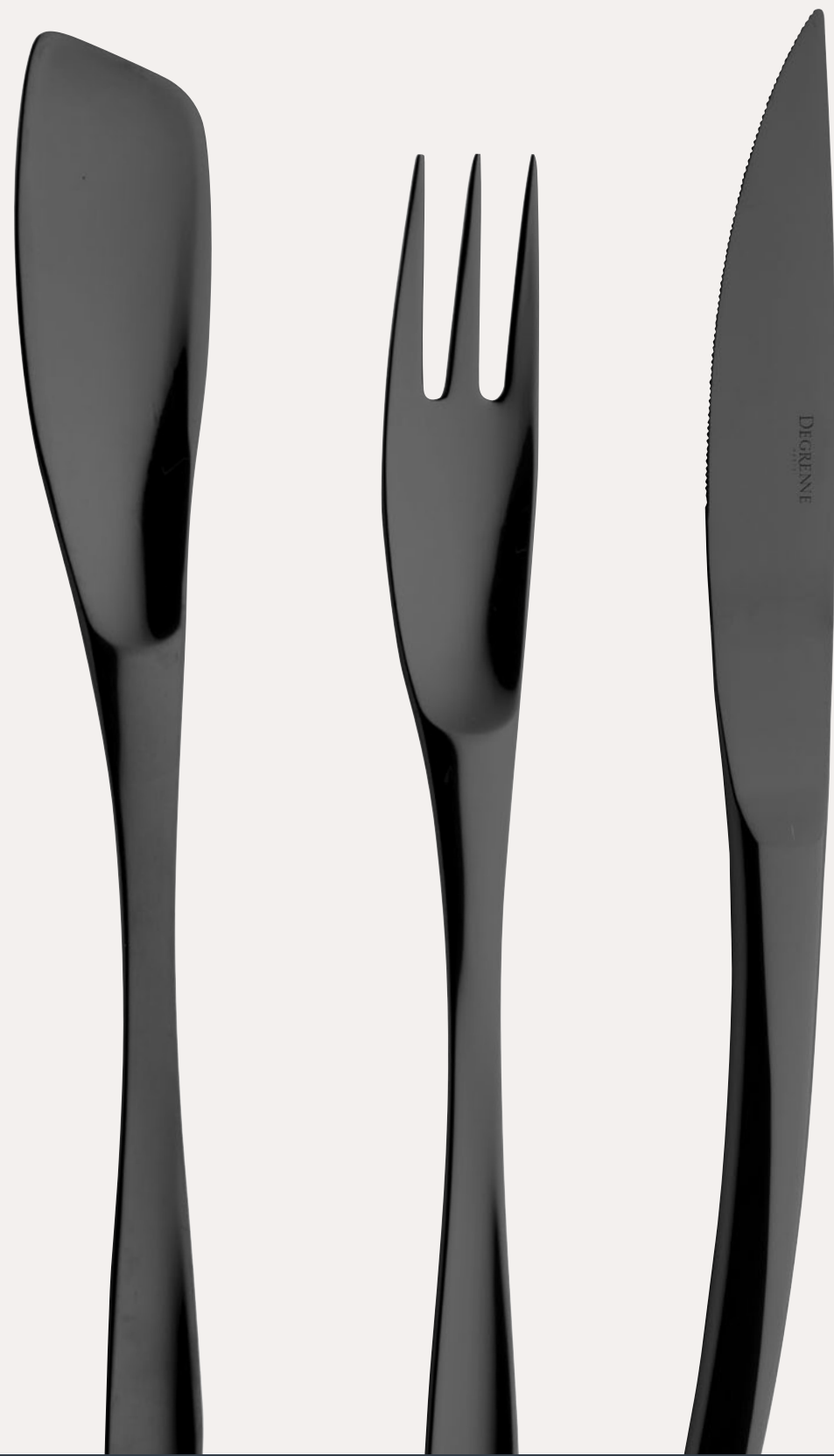

## COUVERTS

Les ateliers DEGRENNE donnent forme aux majestueuses bobines d'acier inoxydable et transforment la matière brute en couverts. Les couverts DEGRENNE bénéficient d'un **savoir-faire unique** et se caractérisent par une **ergonomie et une résistance exceptionnelle**. Faciles d'entretien, ils répondent aux critères les plus exigeants de **qualité, de fonctionnalité et d'esthétique** : la qualité du design et le soin apporté aux finitions font de chacun de nos couverts de **véritables pièces d'orfèvre de style classique ou contemporain**. Créé en collaboration avec des chefs ou en laissant libre cours à l'imagination de nos designers, aux lignes sobres ou plus élaborées, **chaque modèle DEGRENNE trouve sa place à table**.

### FLATWARE

DEGRENNE'S workshops shape the impressive reels of stainless steel and transform the raw material into cutlery. We use our **unique expertise** to create our cutlery, which is characterized by being extraordinarily **easy to use and sturdy**. DEGRENNE cutlery is easy to look after and meets the most stringent **quality, functionality and appearance criteria**. The design quality and painstaking finishes make each of our items of cutlery **true pieces of classic or contemporary silverware**. DEGRENNE cutlery is designed in partnership with chefs or by giving our designers free rein. Some items have simple lines, while others are more elaborate, but **every DEGRENNE design takes pride of place on a table**.

### CUBIERTOS

Los talleres DEGRENNE dan forma a las majestuosas bobinas de acero inoxidable y transforman la materia bruta en cubiertos. Los cubiertos DEGRENNE se benefician de un **saber hacer único** y se caracterizan por una **ergonomía y una resistencia excepcional**. Fáciles de mantener, responden a los criterios más exigentes de **calidad, de funcionalidad y de estética** : La calidad del diseño y el cuidado aportado a los acabados hacen que cada uno de nuestros cubiertos sea una **verdadera pieza de orfebrería de estilo clásico o contemporáneo**. Creado en colaboración con chefs o dando rienda suelta a la imaginación de nuestros diseñadores, con líneas sobrias o más elaboradas, **cada modelo DEGRENNE encuentra su lugar en la mesa**.

XY BLACK MIROIR  
205572 - SPATULE GOURMET  
GOURMET SPATULA - ESPÁTULA GOURMET  
205571 - FOURCHETTE POISSON - FISH FORK - TENEDOR PESCADO  
195028 - COUTEAU DE TABLE MONOBLOC LAME SCIE - TABLE KNIFE SOLID  
HANDLE SERRATED - CUCHILLO DE MESA HOJA SIERRA

P.87







COLLECTIONS  
**DESIGN**





205559  
**FOURCHETTE DE TABLE**  
TABLE FORK  
TENEDOR DE MESA  
21,3 CM - 8 IN<sup>3/8</sup>



193776  
**COUTEAU DE TABLE MONOBLOC LAME SCIE**  
TABLE KNIFE SOLID HANDLE SERRATED  
CUCHILLO DE MESA HOJA SIERRA  
23,3 CM - 9 IN<sup>5/16</sup>



205560  
**CUILLÈRE DE TABLE**  
TABLE/PASTA SPOON  
CUCHARA DE MESA  
20,5 CM - 8 IN<sup>1/16</sup>



205561  
**CUILLÈRE À SOUPE ANGLAISE**  
BOUILLON SPOON, ROUND  
CUCHARA DE CONSOMÉ  
18,5 CM - 7 IN<sup>5/16</sup>



205567  
**CUILLÈRE GOURMANDE**  
DESSERT /SOUP SPOON, OVAL  
CUCHARA DE POSTRE  
18,6 CM - 7 IN<sup>5/16</sup>



205566  
**FOURCHETTE GOURMANDE**  
DESSERT /SALAD FORK  
TENEDOR DE POSTRE  
18,6 CM - 7 IN<sup>5/16</sup>



181111  
**COUTEAU À DESSERT MONOBLOC LAME UNIE**  
DESSERT KNIFE SOLID HANDLE  
CUCHILLO DE POSTRE HOJA LISA  
20,6 CM - 8 IN<sup>1/8</sup>



181112  
**TARTINEUR**  
BUTTER SPREADER  
ESPATULÍN PARA MANTEQUILLA  
16 CM - 6 IN<sup>5/16</sup>



205563  
**FOURCHETTE À POISSON**  
FISH FORK  
TENEDOR DE PESCADO  
20 CM - 7 IN<sup>7/8</sup>



205564  
**SPATULE GOURMET**  
GOURMET SPATULA  
ESPÁTULA GOURMET  
20,2 CM - 7 IN<sup>5/16</sup>



205565  
**FOURCHETTE GOURMET**  
GOURMET FORK  
TENEDOR GOURMET  
20 CM - 7 IN<sup>7/8</sup>



205562  
**CUILLÈRE À CAFÉ**  
COFFEE/TEA SPOON  
CUCHARA DE CAFÉ  
14,3 CM - 5 IN<sup>5/8</sup>



181109  
**CUILLÈRE À MOKA**  
DEMI TASSE SPOON  
CUCHARA DE MOKA  
11 CM - 4 IN<sup>5/16</sup>



190018  
**CUILLÈRE À SODA**  
ICED TEA SPOON  
CUCHARA DE SODA/HELADO  
19 CM - 7 IN<sup>1/2</sup>



181119  
**FOURCHETTE MISE EN BOUCHE**  
COCKTAIL FORK  
TENEDOR PARA APERITIVO  
15,5 CM - 6 IN<sup>1/8</sup>



181120  
**SPATULE MISE EN BOUCHE**  
COCKTAIL SPATULA  
ESPÁTULA PARA APERITIVO  
15,5 CM - 6 IN<sup>1/8</sup>



181121  
**CUILLÈRE MISE EN BOUCHE**  
COCKTAIL SPOON  
CUCHARA PARA APERITIVO  
11,6 CM - 4 IN<sup>9/16</sup>

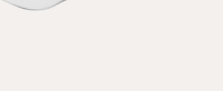

190424  
**FOURCHETTE À HUÎTRES**  
OYSTER FORK  
TENEDOR DE OSTRAS  
14,5 CM - 5 IN<sup>11/16</sup>



181114  
**FOURCHETTE DE SERVICE**  
SERVING FORK  
TENEDOR DE SERVICIO/ENSALADA  
26 CM - 10 IN<sup>1/4</sup>



181113  
**CUILLÈRE DE SERVICE**  
SERVING SPOON  
CUCHARA DE SERVICIO/ENSALADA  
26 CM - 10 IN<sup>1/4</sup>



181122  
**SPATULE DE SERVICE**  
SERVING SPATULA  
ESPÁTULA DE SERVICIO/ENSALADA  
25 CM - 9 IN<sup>13/16</sup>



189999  
**SERVICE À SALADE**  
SALAD SERVING SET  
SET SERVICIO DE ENSALADA  
30 CM - 11 IN<sup>13/16</sup>

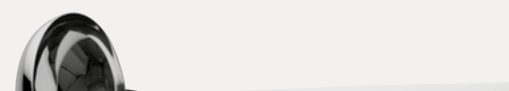

153193  
**LOUCHE**  
SOUP LADLE  
CAZO  
29,7 CM - 11 IN<sup>11/16</sup>



154606  
**LOUCHE À SAUCE**  
SAUCE LADLE  
CUCHARA SALSA  
18,5 CM - 7 IN<sup>5/16</sup>



©Patrick ROUGEREAU



# XY BLACK MIROIR

- |   |  |  |   |
|---|--|--|---|
|    | <b>205568<br/>FOURCHETTE DE TABLE</b><br>TABLE FORK<br>TENEDOR DE MESA<br>21,3 CM - 8 IN <sup>3/8</sup>  |    | <b>195034<br/>CUILLÈRE À MOKA</b><br>DEMI TASSE SPOON<br>CUCHARA DE MOKA<br>11 CM - 4 IN <sup>5/16</sup>                  |
|     | <b>195028<br/>COUTEAU DE TABLE<br/>MONOBLOC LAME SCIE</b><br>TABLE KNIFE SOLID HANDLE SERRATED<br>CUCHILLO DE MESA HOJA SIERRA<br>23,3 CM - 9 IN <sup>3/16</sup> |    | <b>196674<br/>CUILLÈRE À SODA</b><br>ICED TEA SPOON<br>CUCHARA DE SODA/HELADO<br>19 CM - 7 IN <sup>1/2</sup>              |
|    | <b>205569<br/>CUILLÈRE DE TABLE</b><br>TABLE/PASTA SPOON<br>CUCHARA DE MESA<br>20,5 CM - 8 IN <sup>1/16</sup>  |    | <b>195039<br/>FOURCHETTE MISE EN BOUCHE</b><br>COCKTAIL FORK<br>TENEDOR PARA APERITIVO<br>15,5 CM - 6 IN <sup>1/8</sup>   |
|    | <b>200483<br/>CUILLÈRE À SOUPE ANGLAISE</b><br>BOUILLON SPOON, ROUND<br>CUCHARA DE CONSOMÉ<br>18,5 CM - 7 IN <sup>5/16</sup>                                     |    | <b>195042<br/>SPATULE MISE EN BOUCHE</b><br>COCKTAIL SPATULA<br>ESPÁTULA PARA APERITIVO<br>15,5 CM - 6 IN <sup>1/8</sup>  |
|    | <b>205575<br/>CUILLÈRE GOURMANDE</b><br>DESSERT /SOUP SPOON, OVAL<br>CUCHARA DE POSTRE<br>18,6 CM - 7 IN <sup>5/16</sup>   |    | <b>195041<br/>CUILLÈRE MISE EN BOUCHE</b><br>COCKTAIL SPOON<br>CUCHARA PARA APERITIVO<br>11,6 CM - 4 IN <sup>9/16</sup>   |
|  | <b>205574<br/>FOURCHETTE GOURMANDE</b><br>DESSERT /SALAD FORK<br>TENEDOR DE POSTRE<br>18,6 CM - 7 IN <sup>5/16</sup>   |  | <b>196014<br/>FOURCHETTE À HUÎTRES</b><br>OYSTER FORK<br>TENEDOR DE OSTRAS<br>14,1 CM - 5 IN <sup>9/16</sup>              |
|  | <b>195031<br/>COUTEAU À DESSERT<br/>MONOBLOC LAME UNIE</b><br>DESSERT KNIFE SOLID HANDLE<br>CUCHILLO DE POSTRE HOJA LISA<br>20,6 CM - 8 IN <sup>1/8</sup>        |  | <b>199773<br/>FOURCHETTE DE SERVICE</b><br>SERVING FORK<br>TENEDOR DE SERVICIO/ENSALADA<br>26 CM - 10 IN <sup>1/4</sup>   |
|  | <b>195036<br/>TARTINEUR</b><br>BUTTER SPREADER<br>ESPATULÍN PARA MANTEQUILLA<br>16 CM - 6 IN <sup>5/16</sup>   |  | <b>199774<br/>CUILLÈRE DE SERVICE</b><br>SERVING SPOON<br>CUCHARA DE SERVICIO/ENSALADA<br>26 CM - 10 IN <sup>1/4</sup>    |
|  | <b>205571<br/>FOURCHETTE À POISSON</b><br>FISH FORK<br>TENEDOR DE PESCADO<br>20 CM - 7 IN <sup>7/8</sup>   |  | <b>199769<br/>SPATULE DE SERVICE</b><br>SERVING SPATULA<br>ESPÁTULA DE SERVICIO/ENSALADA<br>25 CM - 9 IN <sup>13/16</sup> |
|   | <b>205572<br/>SPATULE GOURMET</b><br>GOURMET SPATULA<br>ESPÁTULA GOURMET<br>20,2 CM - 7 IN <sup>15/16</sup>  |  | <b>199771<br/>SERVICE À SALADE</b><br>SALAD SERVING SET<br>SET SERVICIO DE ENSALADA<br>30 CM - 11 IN <sup>13/16</sup>     |
|  | <b>205573<br/>FOURCHETTE GOURMET</b><br>GOURMET FORK<br>TENEDOR GOURMET<br>20 CM - 7 IN <sup>7/8</sup>   |  |   |
|  | <b>205570<br/>CUILLÈRE À CAFÉ</b><br>COFFEE/TEA SPOON<br>CUCHARA DE CAFÉ<br>14,3 CM - 5 IN <sup>5/8</sup>  |  |   |



LES COUVERTS  
PLATWARE - CUBIERTOS



DEGINNE



SERENITY

LES COUVERTS  
FLATWARE - CUBIERTOS



143770  
**FOURCHETTE DE TABLE**  
TABLE FORK  
TENEDOR DE MESA  
20,9 CM - 8 IN<sup>3/16</sup>

159484  
**COUTEAU DE TABLE MONOBLOC LAME SCIE**  
TABLE KNIFE SOLID HANDLE SERRATED  
CUCHILLO DE MESA HOJA SIERRA  
23,2 CM - 9 IN<sup>1/8</sup>

208624  
**COUTEAU DE TABLE MONOBLOC LAME SCIE**  
TABLE KNIFE SOLID HANDLE SERRATED  
CUCHILLO DE MESA HOJA SIERRA  
23 CM - 9 IN<sup>7/16</sup>

159451  
**COUTEAU À STEAK MONOBLOC LAME SCIE**  
STEAK KNIFE SOLID HANDLE SERRATED  
CUCHILLO DE STEAK HOJA SIERRA  
23,5 CM - 9 IN<sup>1/4</sup>

143767  
**CUILLÈRE DE TABLE**  
TABLE/ PASTA SPOON  
CUCHARA DE MESA  
21,2 CM - 8 IN<sup>3/8</sup>

148852  
**CUILLÈRE À SOUPE ANGLAISE**  
BOUILLON SPOON, ROUND  
CUCHARA DE CONSOMÉ  
17,1 CM - 6 IN<sup>3/4</sup>

143801  
**CUILLÈRE À DESSERT**  
DESSERT/SOUP SPOON, OVAL  
CUCHARA DE POSTRE  
18,7 CM - 7 IN<sup>3/8</sup>

143804  
**FOURCHETTE À DESSERT**  
DESSERT/SALAD FORK  
TENEDOR DE POSTRE  
18,4 CM - 7 IN<sup>1/4</sup>

159492  
**COUTEAU À DESSERT MONOBLOC LAME UNIE**  
DESSERT KNIFE SOLID HANDLE  
CUCHILLO DE POSTRE HOJA LISA  
20,4 CM - 8 IN<sup>1/16</sup>

208625  
**COUTEAU À DESSERT MONOBLOC LAME SCIE**  
DESSERT KNIFE SOLID HANDLE  
SERRATED  
CUCHILLO DE POSTRE  
HOJA SIERRA  
20,7 CM - 8 IN<sup>1/8</sup>

181112  
**TARTINEUR**  
BUTTER SPREADER  
ESPATULIN PARA MANTEQUILLA  
16 CM - 6 IN<sup>5/16</sup>

143790  
**FOURCHETTE À POISSON**  
FISH FORK  
TENEDOR DE PESCADO  
18,5 CM - 7 IN<sup>1/16</sup>



181467  
**COUTEAU À POISSON/ GOURMET**  
GOURMET/FISH KNIFE  
CUCHILLO DE PESCADO  
20,1 CM - 7 IN<sup>15/16</sup>

143772  
**CUILLÈRE À CAFÉ**  
COFFEE/TEA SPOON  
CUCHARA DE CAFÉ  
14,9 CM - 5 IN<sup>7/8</sup>

148855  
**CUILLÈRE À MOKA**  
DEMI TASSE SPOON  
CUCHARA DE MOKA  
11 CM - 4 IN<sup>5/16</sup>

190018  
**CUILLÈRE À SODA**  
ICED TEA SPOON  
CUCHARA DE SODA/HELADO  
19 CM - 7 IN<sup>1/2</sup>

143782  
**FOURCHETTE À GÂTEAUX/ COCKTAIL**  
PASTRY/COCKTAIL FORK  
TENEDOR DE PASTEL  
14,9 CM - 5 IN<sup>7/8</sup>

190424  
**FOURCHETTE À HÛÎTRES**  
OYSTER FORK  
TENEDOR DE OSTRAS  
14,1 CM - 5 IN<sup>9/16</sup>

197522  
**FOURCHETTE DE SERVICE**  
SERVING FORK  
TENEDOR DE SERVICIO/ENSALADA  
26,6 CM - 10 IN<sup>1/2</sup>

197523  
**CUILLÈRE DE SERVICE**  
SERVING SPOON  
CUCHARA DE SERVICIO/ENSALADA  
27 CM - 10 IN<sup>5/8</sup>

197525  
**SERVICE À SALADE**  
SALAD SERVING SET  
SET SERVICIO DE ENSALADA  
30 CM - 11 IN<sup>13/16</sup>

197527  
**PELLE À TARTE MONOBLOC**  
PASTRY SERVER SOLID HANDLE  
PALA PARA TARTA  
25,1 CM - 9 IN<sup>7/8</sup>

153193  
**LOUCHE**  
SOUP LADLE  
CAZO  
29,7 CM - 11 IN<sup>11/16</sup>























154606  
**CUILLÈRE À SAUCE**  
SAUCE LADLE  
CUCHARA DE SALSA  
18,5 CM - 7 IN<sup>1/16</sup>

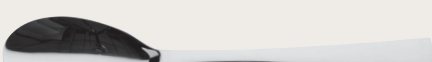

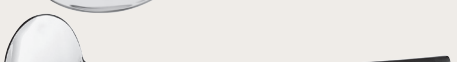
©Patrick ROUGEREAU



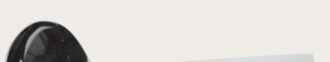

- |   |  |  |   |
|---|--|--|---|
|    | <b>205540</b><br><b>FOURCHETTE DE TABLE</b><br>TABLE FORK<br>TENEDOR DE MESA<br>20,9 CM - 8 IN <sup>3/16</sup>   |    | <b>205545</b><br><b>COUTEAU À POISSON/<br/>GOURMET</b><br>GOURMET/FISH KNIFE<br>CUCHILLO DE PESCADO<br>20,7 CM - 8 IN <sup>7/8</sup>      |
|     | <b>159484</b><br><b>COUTEAU DE TABLE<br/>MONOBLOC LAME SCIE</b><br>TABLE KNIFE SOLID HANDLE SERRATED<br>CUCHILLO DE MESA HOJA SIERRA<br>23,2 CM - 9 IN <sup>1/8</sup>            |    | <b>205543</b><br><b>CUILLÈRE À CAFÉ</b><br>COFFEE/TEA SPOON<br>CUCHARA DE CAFÉ<br>14 CM - 5 IN <sup>1/2</sup>                             |
|     | <b>208624</b><br><b>COUTEAU DE TABLE<br/>MONOBLOC LAME SCIE</b><br>TABLE KNIFE SOLID HANDLE SERRATED<br>CUCHILLO DE MESA HOJA SIERRA<br>23 CM - 9 IN <sup>7/8</sup>              |    | <b>159512</b><br><b>CUILLÈRE À MOKA</b><br>DEMI TASSE SPOON<br>CUCHARA DE MOKA<br>11,1 CM - 4 IN <sup>3/8</sup>                           |
|     | <b>159451</b><br><b>COUTEAU À STEAK<br/>MONOBLOC LAME SCIE</b><br>STEAK KNIFE SOLID HANDLE SERRATED<br>CUCHILLO DE STEAK HOJA SIERRA<br>23,5 CM - 9 IN <sup>1/4</sup>            |    | <b>190018</b><br><b>CUILLÈRE À SODA</b><br>ICED TEA SPOON<br>CUCHARA DE SODA/HELADO<br>19 CM - 7 IN <sup>1/2</sup>                        |
|    | <b>205541</b><br><b>CUILLÈRE DE TABLE</b><br>TABLE/PASTA SPOON<br>CUCHARA DE MESA<br>20,9 CM - 8 IN <sup>1/4</sup>   |    | <b>205548</b><br><b>FOURCHETTE À GÂTEAUX/<br/>COCKTAIL</b><br>PASTRY/COCKTAIL FORK<br>TENEDOR DE PASTEL<br>14,1 CM - 5 IN <sup>9/16</sup> |
|  | <b>205542</b><br><b>CUILLÈRE À SOUPE ANGLAISE</b><br>BOUILLON SPOON, ROUND<br>CUCHARA DE CONSOMÉ<br>17,8 CM - 7 IN   |  | <b>190424</b><br><b>FOURCHETTE À HÛÎTRES</b><br>OYSTER FORK<br>TENEDOR DE OSTRAS<br>14,5 CM - 5 IN <sup>17/16</sup>                       |
|  | <b>205547</b><br><b>CUILLÈRE À DESSERT</b><br>DESSERT/SOUP SPOON, OVAL<br>CUCHARA DE POSTRE<br>18,4 CM - 7 IN <sup>1/4</sup>   |  | <b>159501</b><br><b>FOURCHETTE DE SERVICE</b><br>SERVING FORK<br>TENEDOR DE SERVICIO/ENSALADA<br>26 CM - 10 IN <sup>1/4</sup>             |
|  | <b>205546</b><br><b>FOURCHETTE À DESSERT</b><br>DESSERT/SALAD FORK<br>TENEDOR DE POSTRE<br>18,4 CM - 7 IN <sup>1/4</sup>   |  | <b>159500</b><br><b>CUILLÈRE DE SERVICE</b><br>SERVING SPOON<br>CUCHARA DE SERVICIO/ENSALADA<br>26 CM - 10 IN <sup>1/4</sup>              |
|  | <b>159492</b><br><b>COUTEAU À DESSERT<br/>MONOBLOC LAME UNIE</b><br>DESSERT KNIFE SOLID HANDLE<br>CUCHILLO DE POSTRE HOJA LISA<br>20,4 CM - 8 IN <sup>1/8</sup>                  |  | <b>159504</b><br><b>SERVICE À SALADE</b><br>SALAD SERVING SET<br>SET SERVICIO DE ENSALADA<br>30 CM - 11 IN <sup>13/16</sup>               |
|  | <b>208625</b><br><b>COUTEAU À DESSERT<br/>MONOBLOC LAME SCIE</b><br>DESSERT KNIFE SOLID HANDLE<br>SERRATED<br>CUCHILLO DE POSTRE<br>HOJA SIERRA<br>20,7 CM - 8 IN <sup>7/8</sup> |  | <b>159490</b><br><b>PELLE À TARTE<br/>MONOBLOC</b><br>PASTRY SERVER SOLID HANDLE<br>PALA PARA TARTA<br>26,2 CM - 10 IN <sup>1/4</sup>     |
|  | <b>154612</b><br><b>COUTEAU À BEURRE<br/>MONOBLOC LAME UNIE</b><br>BUTTER KNIFE SOLID HANDLE<br>CUCHILLO DE MANTEQUILLA HOJA LISA<br>19,4 CM - 7 IN <sup>5/8</sup>               |  | <b>153193</b><br><b>LOUCHE</b><br>SOUP LADLE<br>CAZO<br>29,7 CM - 11 IN <sup>11/16</sup>  |
|  | <b>205544</b><br><b>FOURCHETTE À POISSON</b><br>FISH FORK<br>TENEDOR DE PESCADO<br>18,4 CM - 7 IN <sup>1/4</sup>   |  | <b>154606</b><br><b>CUILLÈRE À SAUCE</b><br>SAUCE LADLE<br>CUCHARA DE SALSA<br>18,5 CM - 7 IN <sup>37/64</sup>                            |







233011  
**FOURCHETTE DE TABLE**  
TABLE FORK  
TENEDOR DE MESA  
20,5 CM - 8 IN<sup>7/8</sup>



233013  
**COUTEAU DE TABLE MONOBLOC À BOUT POINTU LAME SCIE**  
TABLE KNIFE SOLID HANDLE POINTED BLADE SERRATED  
CUCHILLO DE MESA HOJA SIERRA  
23,3 CM - 9 IN<sup>3/8</sup>



233014  
**COUTEAU DE TABLE MONOBLOC À BOUT ROND LAME SCIE**  
TABLE KNIFE SOLID HANDLE ROUNDED BLADE SERRATED  
CUCHILLO DE MESA HOJA SIERRA  
23,3 CM - 9 IN<sup>3/8</sup>



229520  
**COUTEAU DE TABLE MONOCOQUE MANCHE ORFÈVRE LAME UNIE**  
TABLE KNIFE HOLLOW HANDLE  
CUCHILLO DE MESA ENMANGADO HOJA LISA  
23,3 CM - 9 IN<sup>3/8</sup>



233012  
**CUILLÈRE DE TABLE**  
TABLE/ PASTA SPOON  
CUCHARA DE MESA  
20,5 CM - 8 IN<sup>7/8</sup>



233022  
**CUILLÈRE À SOUPE ANGLAISE**  
BOUILLON SPOON, ROUND  
CUCHARA DE CONSOMÉ  
18,5 CM - 7 IN<sup>5/8</sup>



233018  
**CUILLÈRE À DESSERT**  
DESSERT/SOUP SPOON  
CUCHARA DE POSTRE  
18,5 CM - 7 IN<sup>5/8</sup>



233017  
**FOURCHETTE À DESSERT**  
DESSERT/SALAD FORK  
TENEDOR DE POSTRE  
18,5 CM - 7 IN<sup>5/8</sup>



233019  
**COUTEAU À DESSERT MONOBLOC À BOUT ROND LAME UNIE**  
DESSERT KNIFE SOLID HANDLE ROUNDED BLADE  
CUCHILLO DE POSTRE HOJA LISA  
20,9 CM - 8 IN<sup>1/4</sup>



233023  
**COUTEAU À BEURRE MONOBLOC LAME UNIE**  
BUTTER KNIFE SOLID HANDLE  
CUCHILLO DE MANTEQUILLA HOJA LISA  
17,5 CM - 6 IN<sup>7/8</sup>



233021  
**CUILLÈRE GOURMET**  
GOURMET SPOON  
CUCHARA PARA SALSA  
18,5 CM - 7 IN<sup>5/8</sup>



233015  
**CUILLÈRE À CAFÉ**  
COFFEE/TEA SPOON  
CUCHARA DE CAFÉ  
13,9 CM - 5 IN<sup>1/2</sup>



233016  
**CUILLÈRE À MOKA**  
DEMI TASSE SPOON  
CUCHARA DE MOKA  
11,7 CM - 4 IN<sup>5/8</sup>



233020  
**FOURCHETTE À GÂTEAUX/ COCKTAIL**  
PASTRY/COCKTAIL FORK  
TENEDOR DE PASTEL  
13,9 CM - 5 IN<sup>1/2</sup>



233024  
**FOURCHETTE DE SERVICE**  
SERVING FORK  
TENEDOR DE SERVICIO/ENSALADA  
26,3 CM - 10 IN<sup>3/8</sup>



233025  
**CUILLÈRE DE SERVICE**  
SERVING SPOON  
CUCHARA DE SERVICIO/ENSALADA  
26,3 CM - 10 IN<sup>3/8</sup>

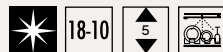

L'ABUS D'ALCOOL EST DANGEREUX POUR LA SANTÉ  
DEGRENNÉ PROMOTES RESPONSIBLE DRINKING AND DISCOURAGES ALCOHOL MISUSE  
EL ABUSO DE ALCOHOL ES PELIGROSO PARA LA SALUD



LES COUVERTS  
FLATWARE - CUBIERTOS



























GUEST MIROIR

LES COUVERTS  
PLATWARE - CUBIERTOS



DEGRENE



- |  |  |
|--|--|
| <br><b>197507</b><br><b>FOURCHETTE DE TABLE</b><br>TABLE FORK<br>TENEDOR DE MESA<br>21,3 CM - 8 IN <sup>3/8</sup>  | <br><b>197515</b><br><b>COUPEAU À POISSON/<br/>GOURMET</b><br>GOURMET/FISH KNIFE<br>CUCHILLO DE PESCADO<br>21,3 CM - 8 IN <sup>3/8</sup>     |
| <br><b>197509</b><br><b>COUPEAU DE TABLE<br/>MONOBLOC LAME SCIE</b><br>TABLE KNIFE SOLID HANDLE SERRATED<br>CUCHILLO DE MESA HOJA SIERRA<br>23,2 CM - 9 IN <sup>1/8</sup>                      | <br><b>197508</b><br><b>CUILLÈRE À CAFÉ</b><br>COFFEE/TEA SPOON<br>CUCHARA DE CAFÉ<br>14,3 CM - 5 IN <sup>5/8</sup>                          |
| <p><b>NEW</b></p> <br><b>235481</b><br><b>COUPEAU DE TABLE<br/>MONOBLOC LAME SCIE</b><br>TABLE KNIFE SOLID HANDLE SERRATED<br>CUCHILLO DE MESA HOJA SIERRA<br>23,7 CM - 9 IN <sup>5/16</sup>   | <br><b>197510</b><br><b>CUILLÈRE À MOKA</b><br>DEMI TASSE SPOON<br>CUCHARA DE MOKA<br>11,7 CM - 4 IN <sup>5/8</sup>                          |
| <br><b>197521</b><br><b>COUPEAU À STEAK<br/>MONOBLOC LAME SCIE</b><br>STEAK KNIFE SOLID HANDLE SERRATED<br>CUCHILLO DE STEAK HOJA SIERRA<br>23,2 CM - 9 IN <sup>1/8</sup>                      | <br><b>190018</b><br><b>CUILLÈRE À SODA</b><br>ICED TEA SPOON<br>CUCHARA DE SODA/HELADO<br>19 CM - 7 IN <sup>1/2</sup>                       |
| <br><b>197506</b><br><b>CUILLÈRE DE TABLE</b><br>TABLE/ PASTA SPOON<br>CUCHARA DE MESA<br>21,6 CM - 8 IN <sup>1/2</sup>   | <br><b>197516</b><br><b>FOURCHETTE À GÂTEAUX/<br/>COCKTAIL</b><br>PASTRY/COCKTAIL FORK<br>TENEDOR DE PASTEL<br>13,9 CM - 5 IN <sup>1/2</sup> |
| <br><b>197518</b><br><b>CUILLÈRE À SOUPE ANGLAISE</b><br>BOUILLON SPOON, ROUND<br>CUCHARA DE CONSOMÉ<br>18,5 CM - 7 IN <sup>5/16</sup>  | <br><b>190424</b><br><b>FOURCHETTE À HUÎTRES</b><br>OYSTER FORK<br>TENEDOR DE OSTRAS<br>14,1 CM - 5 IN <sup>5/16</sup>                     |
| <br><b>197512</b><br><b>CUILLÈRE À DESSERT</b><br>DESSERT/SOUP SPOON, OVAL<br>CUCHARA DE POSTRE<br>19,5 CM - 7 IN <sup>11/16</sup>  | <br><b>197522</b><br><b>FOURCHETTE DE SERVICE</b><br>SERVING FORK<br>TENEDOR DE SERVICIO/ENSALADA<br>26,6 CM - 10 IN <sup>1/2</sup>        |
| <br><b>197511</b><br><b>FOURCHETTE À DESSERT</b><br>DESSERT/SALAD FORK<br>TENEDOR DE POSTRE<br>19,2 CM - 7 IN <sup>3/16</sup>   | <br><b>197523</b><br><b>CUILLÈRE DE SERVICE</b><br>SERVING SPOON<br>CUCHARA DE SERVICIO/ENSALADA<br>27 CM - 10 IN <sup>5/8</sup>           |
| <br><b>210629</b><br><b>COUPEAU À DESSERT<br/>MONOBLOC LAME SCIE</b><br>DESSERT KNIFE SOLID HANDLE<br>SERRATED<br>CUCHILLO DE POSTRE HOJA SIERRA<br>20,9 CM - 8 IN <sup>3/16</sup>          | <br><b>197525</b><br><b>SERVICE À SALADE</b><br>SALAD SERVING SET<br>SET SERVICIO DE ENSALADA<br>30 CM - 11 IN <sup>13/16</sup>            |
| <p><b>NEW</b></p> <br><b>235482</b><br><b>COUPEAU DE TABLE<br/>MONOBLOC LAME SCIE</b><br>TABLE KNIFE SOLID HANDLE SERRATED<br>CUCHILLO DE MESA HOJA SIERRA<br>21,3 CM - 8 IN <sup>3/8</sup> | <br><b>197527</b><br><b>PELLE À TARTE<br/>MONOBLOC</b><br>PASTRY SERVER SOLID HANDLE<br>PALA PARA TARTA<br>25,1 CM - 9 IN <sup>7/8</sup>   |
| <br><b>197520</b><br><b>COUPEAU À BEURRE<br/>MONOBLOC LAME UNIE</b><br>BUTTER KNIFE SOLID HANDLE<br>CUCHILLO PARA MANTEQUILLA HOJA LISA<br>19,3 CM - 7 IN <sup>5/8</sup>                    | <br><b>153193</b><br><b>LOUCHE</b><br>SOUP LADLE<br>CAZO<br>29,7 CM - 11 IN <sup>11/16</sup>   |
| <br><b>197514</b><br><b>FOURCHETTE À POISSON</b><br>FISH FORK<br>TENEDOR DE PESCADO<br>19,2 CM - 7 IN <sup>3/16</sup>   | <br><b>154606</b><br><b>CUILLÈRE À SAUCE</b><br>SAUCE LADLE<br>CUCHARA DE SALSA<br>18,5 CM - 7 IN <sup>3/8</sup>                           |

LABUS D'ALCOOL EST DANGEREUX POUR LA SANTÉ  
 DEGRENE PROMOTES RESPONSIBLE DRINKING AND DISCOURAGES ALCOHOL MISUSE  
 EL ABUSO DE ALCOHOL ES PELIGROSO PARA LA SALUD







223482  
**FOURCHETTE DE TABLE**  
TABLE FORK  
TENEDOR DE MESA  
21,3 CM - 8 IN<sup>3/8</sup>



202995  
**COUPEAU DE TABLE**  
**MONOBLOC LAME SCIE**  
TABLE KNIFE SOLID HANDLE SERRATED  
CUCHILLO DE MESA HOJA SIERRA  
23,2 CM - 9 IN<sup>1/8</sup>



203017  
**COUPEAU À STEAK**  
**MONOBLOC LAME SCIE**  
STEAK KNIFE SOLID HANDLE SERRATED  
CUCHILLO DE STEAK HOJA SIERRA  
23,2 CM - 9 IN<sup>1/8</sup>



223481  
**CUILLÈRE DE TABLE**  
TABLE/ PASTA SPOON  
CUCHARA DE MESA  
21,6 CM - 8 IN<sup>1/2</sup>



223491  
**CUILLÈRE À SOUPE ANGLAISE**  
BOUILLON SPOON, ROUND  
CUCHARA DE CONSOMÉ  
18,5 CM - 7 IN<sup>5/16</sup>



223486  
**CUILLÈRE À DESSERT**  
DESSERT/SOUP SPOON, OVAL  
CUCHARA DE POSTRE  
19,5 CM - 7 IN<sup>17/16</sup>



223485  
**FOURCHETTE À DESSERT**  
DESSERT/SALAD FORK  
TENEDOR DE POSTRE  
19,2 CM - 7 IN<sup>3/16</sup>



210630  
**COUPEAU À DESSERT**  
**MONOBLOC LAME SCIE**  
DESSERT KNIFE SOLID HANDLE  
SERRATED  
CUCHILLO DE POSTRE HOJA SIERRA  
20,9 CM - 8 IN<sup>3/16</sup>



203016  
**COUPEAU À BEURRE**  
**MONOBLOC LAME UNIE**  
BUTTER KNIFE SOLID HANDLE  
CUCHILLO DE MANTEQUILLA HOJA LISA  
19,3 CM - 7 IN<sup>5/16</sup>



223487  
**FOURCHETTE À POISSON**  
FISH FORK  
TENEDOR DE PESCADO  
19,2 CM - 7 IN<sup>3/16</sup>



223488  
**COUPEAU À POISSON/**  
**GOURMET**  
GOURMET/FISH KNIFE  
CUCHILLO DE PESCADO  
21,3 CM - 8 IN<sup>3/8</sup>



223483  
**CUILLÈRE À CAFÉ**  
COFFEE/TEA SPOON  
CUCHARA DE CAFÉ  
14,3 CM - 5 IN<sup>5/8</sup>



223484  
**CUILLÈRE À MOKA**  
DEMI TASSE SPOON  
CUCHARA DE MOKA  
11,7 CM - 4 IN<sup>5/8</sup>



223492  
**CUILLÈRE À SODA**  
ICED TEA SPOON  
CUCHARA DE SODA/HELADO  
18,9 CM - 7 IN<sup>7/16</sup>



223489  
**FOURCHETTE À GÂTEAUX/**  
**COCKTAIL**  
PASTRY/COCKTAIL FORK  
TENEDOR DE PASTEL  
13,9 CM - 5 IN<sup>1/2</sup>



223493  
**FOURCHETTE DE SERVICE**  
SERVING FORK  
TENEDOR DE SERVICIO/ENSALADA  
26,6 CM - 10 IN<sup>1/2</sup>



223494  
**CUILLÈRE DE SERVICE**  
SERVING SPOON  
CUCHARA DE SERVICIO/ENSALADA  
27 CM - 10 IN<sup>5/8</sup>



223496  
**SERVICE À SALADE**  
SALAD SERVING SET  
SET SERVICIO DE ENSALADA  
30 CM - 11 IN<sup>13/16</sup>



223497  
**PELLE À TARTE**  
**MONOBLOC**  
PASTRY SERVER SOLID HANDLE  
PALA PARA TARTA  
25,1 CM - 9 IN<sup>7/8</sup>



LES COUVERTS  
FLATWARE - CUBIERTOS



GUEST CUIVRE  
COPPER



230848  
**FOURCHETTE DE TABLE**  
TABLE FORK  
TENEDOR DE MESA  
21,3 CM - 8 IN<sup>3/8</sup>



230850  
**COUTEAU DE TABLE  
MONOBLOC LAME SCIE**  
TABLE KNIFE SOLID HANDLE SERRATED  
CUCHILLO DE MESA HOJA SIERRA  
23,2 CM - 9 IN<sup>1/8</sup>



230849  
**CUILLÈRE DE TABLE**  
TABLE/ PASTA SPOON  
CUCHARA DE MESA  
21,6 CM - 8 IN<sup>1/2</sup>



230854  
**CUILLÈRE À DESSERT**  
DESSERT/SOUP SPOON, OVAL  
CUCHARA DE POSTRE  
19,5 CM - 7 IN<sup>3/16</sup>



230853  
**FOURCHETTE À DESSERT**  
DESSERT/SALAD FORK  
TENEDOR DE POSTRE  
19,2 CM - 7 IN<sup>3/16</sup>



230855  
**COUTEAU À DESSERT  
MONOBLOC LAME SCIE**  
DESSERT KNIFE SOLID HANDLE  
SERRATED  
CUCHILLO DE POSTRE HOJA SIERRA  
20,9 CM - 8 IN<sup>3/16</sup>



230851  
**CUILLÈRE À CAFÉ**  
COFFEE/TEA SPOON  
CUCHARA DE CAFÉ  
14,3 CM - 5 IN<sup>3/8</sup>



230852  
**CUILLÈRE À MOKA**  
DEMI TASSE SPOON  
CUCHARA DE MOKA  
11,7 CM - 4 IN<sup>5/8</sup>



LES COUVERTS  
FLATWARE - CUBIERTOS





©Patrick ROUGEREAU



- 

217139  
**FOURCHETTE DE TABLE**  
TABLE FORK  
TENEDOR DE MESA  
21,3 CM - 8 IN<sup>3/8</sup>
- 

217140  
**COUPEAU DE TABLE  
MONOBLOC LAME SCIE**  
TABLE KNIFE SOLID HANDLE SERRATED  
CUCHILLO DE MESA HOJA SIERRA  
23,2 CM - 9 IN<sup>1/8</sup>
- 

230339  
**COUPEAU À STEAK  
MONOBLOC LAME SCIE**  
STEAK KNIFE SOLID HANDLE SERRATED  
CUCHILLO DE STEAK HOJA SIERRA  
23,2 CM - 9 IN<sup>1/8</sup>
- 

217141  
**CUILLÈRE DE TABLE**  
TABLE/ PASTA SPOON  
CUCHARA DE MESA  
21,6 CM - 8 IN<sup>1/2</sup>
- 

217143  
**CUILLÈRE À DESSERT**  
DESSERT/SOUP SPOON, OVAL  
CUCHARA DE POSTRE  
19,5 CM - 7 IN<sup>11/16</sup>
- 

217144  
**FOURCHETTE À DESSERT**  
DESSERT/SALAD FORK  
TENEDOR DE POSTRE  
19,2 CM - 7 IN<sup>3/16</sup>
- 

217145  
**COUPEAU À DESSERT  
MONOBLOC LAME SCIE**  
DESSERT KNIFE SOLID HANDLE  
SERRATED  
CUCHILLO DE POSTRE HOJA SIERRA  
20,9 CM - 8 IN<sup>3/16</sup>

- 

232307  
**TARTINEUR**  
BUTTER SPREADER  
ESPATULIN PARA MANTEQUILLA  
16 CM - 6 IN<sup>5/16</sup>
- 

230411  
**FOURCHETTE À POISSON**  
FISH FORK  
TENEDOR DE PESCADO  
19,2 CM - 7 IN<sup>3/16</sup>
- 

230412  
**COUPEAU À POISSON/  
GOURMET**  
GOURMET/FISH KNIFE  
CUCHILLO DE PESCADO  
21,3 CM - 8 IN<sup>3/8</sup>
- 

217142  
**CUILLÈRE À CAFÉ**  
COFFEE/TEA SPOON  
CUCHARA DE CAFÉ  
14,3 CM - 5 IN<sup>3/8</sup>
- 

217146  
**CUILLÈRE À MOKA**  
DEMI TASSE SPOON  
CUCHARA DE MOKA  
11,7 CM - 4 IN<sup>5/8</sup>



LES COUVERTS  
FLATWARE - CUBIERTOS

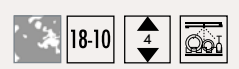

© PATRICK ROUGEREAU





126355  
**FOURCHETTE DE TABLE**  
TABLE FORK  
TENEDOR DE MESA  
20,1 CM - 7 IN<sup>5/16</sup>



126358  
**CUILLÈRE À CAFÉ**  
COFFEE/TEA SPOON  
CUCHARA DE CAFÉ  
13,7 CM - 5 IN<sup>3/8</sup>



210731  
**COUTEAU DE TABLE**  
**MONOBLOC LAME SCIE**  
TABLE KNIFE SOLID HANDLE SERRATED  
CUCHILLO DE MESA HOJA SIERRA  
23,5 CM - 9 IN<sup>1/4</sup>



140852  
**CUILLÈRE À MOKA**  
DEMI TASSE SPOON  
CUCHARA DE MOKA  
11 CM - 4 IN<sup>5/16</sup>



207189  
**COUTEAU À STEAK**  
**MONOBLOC LAME SCIE**  
STEAK KNIFE SOLID HANDLE SERRATED  
CUCHILLO DE STEAK HOJA SIERRA  
23,6 CM - 9 IN<sup>5/16</sup>



189973  
**CUILLÈRE À SODA**  
ICED TEA SPOON  
CUCHARA DE SODA/HELADO  
19 CM - 7 IN<sup>1/2</sup>



126352  
**CUILLÈRE DE TABLE**  
TABLE/ PASTA SPOON  
CUCHARA DE MESA  
20,3 CM - 8 IN



126383  
**FOURCHETTE À GÂTEAUX**  
**COCKTAIL**  
PASTRY/COCKTAIL FORK  
TENEDOR DE PASTEL  
13,7 CM - 5 IN<sup>3/8</sup>



140855  
**CUILLÈRE À SOUPE ANGLAISE**  
BOUILLON SPOON, ROUND  
CUCHARA DE CONSOMÉ  
17,9 CM - 7 IN<sup>7/16</sup>



189974  
**FOURCHETTE À HUÎTRES**  
OYSTER FORK  
TENEDOR DE OSTRAS  
14,1 CM - 5 IN<sup>7/16</sup>



126368  
**CUILLÈRE À DESSERT**  
DESSERT/SOUP SPOON, OVAL  
CUCHARA DE POSTRE  
17,8 CM - 7 IN



231218  
**FOURCHETTE DE SERVICE**  
SERVING FORK  
TENEDOR DE SERVICIO/ENSALADA  
26,6 CM - 10 IN<sup>1/2</sup>



126371  
**FOURCHETTE À DESSERT**  
DESSERT/SALAD FORK  
TENEDOR DE POSTRE  
17,7 CM - 6 IN<sup>5/16</sup>



231219  
**CUILLÈRE DE SERVICE**  
SERVING SPOON  
CUCHARA DE SERVICIO/ENSALADA  
26,6 CM - 10 IN<sup>1/2</sup>



210732  
**COUTEAU À DESSERT**  
**MONOBLOC LAME UNIE**  
DESSERT KNIFE SOLID HANDLE  
CUCHILLO DE POSTRE HOJA LISA  
20,7 CM - 8 IN<sup>1/16</sup>



231221  
**PELLE À TARTE**  
**MONOBLOC**  
PASTRY SERVER SOLID HANDLE  
PALA PARA TARTA  
25,2 CM - 9 IN<sup>5/16</sup>



189971  
**COUTEAU À BEURRE**  
**MONOBLOC LAME UNIE**  
BUTTER KNIFE SOLID HANDLE  
CUCHILLO DE MANTEQUILLA HOJA LISA  
18,9 CM - 7 IN<sup>7/16</sup>



231220  
**LOUCHE**  
SOUP LADLE  
CAZO  
29 CM - 11 IN<sup>7/16</sup>



126377  
**FOURCHETTE À POISSON**  
FISH FORK  
TENEDOR DE PESCADO  
17,7 CM - 6 IN<sup>5/16</sup>



181181  
**COUTEAU À POISSON/**  
**GOURMET**  
GOURMET/FISH KNIFE  
CUCHILLO DE PESCADO  
20,1 CM - 7 IN<sup>5/16</sup>



DEGRENE



# ASTRÉE MIROIR

LES COUVERTS  
FLATWARE - CUBIERTOS



153188  
**FOURCHETTE DE TABLE**  
TABLE FORK  
TENEDOR DE MESA  
20,7 CM - 8 IN<sup>5/8</sup>

153196  
**COUTEAU DE TABLE  
MONOBLOC LAME SCIE**  
TABLE KNIFE SOLID HANDLE SERRATED  
CUCHILLO DE MESA HOJA SIERRA  
23,5 CM - 9 IN<sup>1/4</sup>

122418  
**COUTEAU À STEAK  
MONOBLOC LAME SCIE**  
STEAK KNIFE SOLID HANDLE SERRATED  
CUCHILLO DE STEAK HOJA SIERRA  
22,1 CM - 8 IN<sup>5/8</sup>

153185  
**CUILLÈRE DE TABLE**  
TABLE/ PASTA SPOON  
CUCHARA DE MESA  
20,7 CM - 8 IN<sup>5/8</sup>

184758  
**CUILLÈRE À SOUPE ANGLAISE**  
BOUILLON SPOON, ROUND  
CUCHARA DE CONSOMÉ  
18,3 CM - 7 IN<sup>3/8</sup>

153209  
**CUILLÈRE À DESSERT**  
DESSERT/SOUP SPOON, OVAL  
CUCHARA DE POSTRE  
18,6 CM - 7 IN<sup>5/8</sup>

153212  
**FOURCHETTE À DESSERT**  
DESSERT/SALAD FORK  
TENEDOR DE POSTRE  
18,6 CM - 7 IN<sup>5/8</sup>

153200  
**COUTEAU À DESSERT  
MONOBLOC LAME UNIE**  
DESSERT KNIFE SOLID HANDLE  
CUCHILLO DE POSTRE HOJA LISA  
21,1 CM - 8 IN<sup>5/8</sup>

154612  
**COUTEAU À BEURRE  
MONOBLOC LAME UNIE**  
BUTTER KNIFE SOLID HANDLE  
CUCHILLO DE MANTEQUILLA HOJA LISA  
19,4 CM - 7 IN<sup>5/8</sup>

153203  
**FOURCHETTE À POISSON**  
FISH FORK  
TENEDOR DE PESCADO  
18,6 CM - 7 IN<sup>5/8</sup>

153206  
**COUTEAU À POISSON/  
GOURMET**  
GOURMET/FISH KNIFE  
CUCHILLO DE PESCADO  
21,1 CM - 8 IN<sup>5/8</sup>

153191  
**CUILLÈRE À CAFÉ**  
COFFEE/TEA SPOON  
CUCHARA DE CAFÉ  
14,1 CM - 5 IN<sup>5/8</sup>



154609  
**CUILLÈRE À MOKA**  
DEMI TASSE SPOON  
CUCHARA DE MOKA  
11,1 CM - 4 IN<sup>3/8</sup>

190018  
**CUILLÈRE À SODA**  
ICED TEA SPOON  
CUCHARA DE SODA/HELADO  
19 CM - 7 IN<sup>1/2</sup>

197516  
**FOURCHETTE À GÂTEAUX  
COCKTAIL**  
PASTRY/COCKTAIL FORK  
TENEDOR DE PASTEL  
13,9 CM - 5 IN<sup>1/2</sup>

190424  
**FOURCHETTE À HUÎTRES**  
OYSTER FORK  
TENEDOR DE OSTRAS  
14,1 CM - 5 IN<sup>5/8</sup>

162728  
**FOURCHETTE /PIQUE À  
ESCARGOTS/COCKTAIL**  
COCKTAIL/ SNAIL FORK  
TENEDOR DE CARACOL/COCKTAIL  
10,8 CM - 4 IN<sup>1/4</sup>

162730  
**CURETTE À CRUSTACÉS**  
SEAFOOD SCRAPER  
RASQUETA PARA CANGREJO  
19,1 CM - 7 IN<sup>1/2</sup>

197522  
**FOURCHETTE DE SERVICE**  
SERVING FORK  
TENEDOR DE SERVICIO/ENSALADA  
26,6 CM - 10 IN<sup>1/2</sup>

197523  
**CUILLÈRE DE SERVICE**  
SERVING SPOON  
CUCHARA DE SERVICIO/ENSALADA  
27 CM - 10 IN<sup>5/8</sup>

197525  
**SERVICE À SALADE**  
SALAD SERVING SET  
SET SERVICIO DE ENSALADA  
30 CM - 11 IN<sup>3/8</sup>

197527  
**PELLE À TARTE MONOBLOC**  
PASTRY SERVER SOLID HANDLE  
PALA PARA TARTA  
25,1 CM - 9 IN<sup>7/8</sup>

153193  
**LOUCHE**  
SOUP LADLE  
CAZO  
29,7 CM - 11 IN<sup>11/8</sup>

154606  
**LOUCHE À SAUCE**  
SAUCE LADLE  
CAZO PARA SALSA  
18,5 CM - 7 IN<sup>3/8</sup>





# ASTRÉE CISELÉ

LES COUVERTS  
FLATWARE - CUBIERTOS

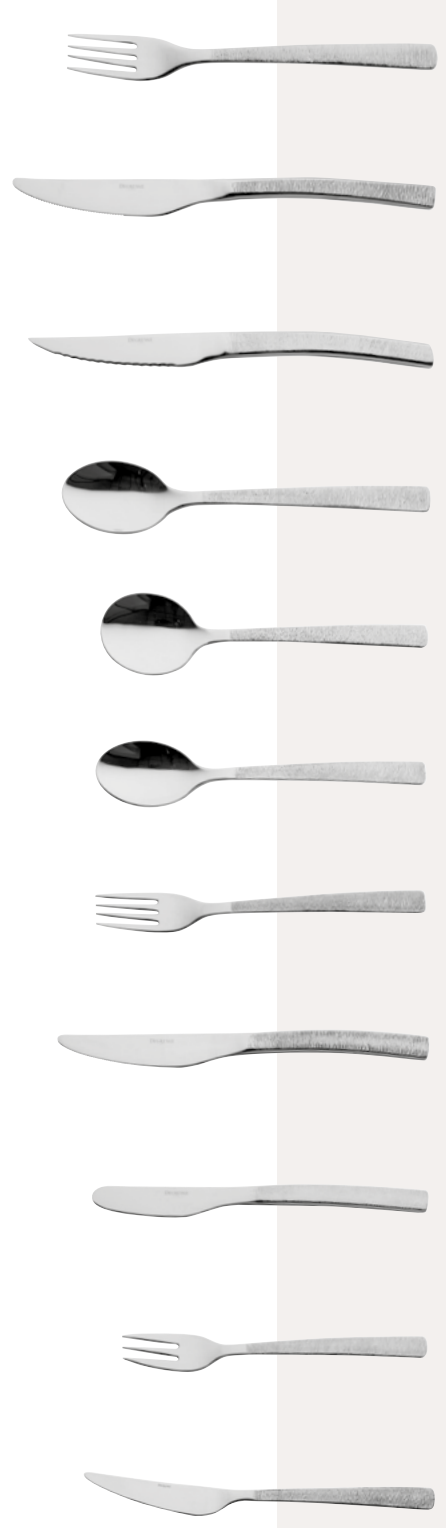

153998  
**FOURCHETTE DE TABLE**  
TABLE FORK  
TENEDOR DE MESA  
20,7 CM - 8 IN<sup>7/8</sup>

154002  
**COUTEAU DE TABLE  
MONOBLOC LAME SCIE**  
TABLE KNIFE SOLID HANDLE SERRATED  
CUCHILLO DE MESA HOJA SIERRA  
23,5 CM - 9 IN<sup>1/4</sup>

199761  
**COUTEAU À STEAK  
MONOBLOC LAME SCIE**  
STEAK KNIFE SOLID HANDLE SERRATED  
CUCHILLO DE STEAK HOJA SIERRA  
22,8 CM - 9 IN

153996  
**CUILLÈRE DE TABLE**  
TABLE/ PASTA SPOON  
CUCHARA DE MESA  
20,7 CM - 8 IN<sup>7/8</sup>

190015  
**CUILLÈRE À SOUPE ANGLAISE**  
BOUILLON SPOON, ROUND  
CUCHARA DE CONSOMÉ  
18,3 CM - 7 IN<sup>3/16</sup>

154571  
**CUILLÈRE À DESSERT**  
DESSERT/SOUP SPOON, OVAL  
CUCHARA DE POSTRE  
18,6 CM - 7 IN<sup>5/16</sup>

154574  
**FOURCHETTE À DESSERT**  
DESSERT/SALAD FORK  
TENEDOR DE POSTRE  
18,6 CM - 7 IN<sup>5/16</sup>

154555  
**COUTEAU À DESSERT  
MONOBLOC LAME UNIE**  
DESSERT KNIFE SOLID HANDLE  
CUCHILLO DE POSTRE HOJA LISA  
21,1 CM - 8 IN<sup>5/16</sup>

154580  
**COUTEAU À BEURRE  
MONOBLOC LAME UNIE**  
BUTTER KNIFE SOLID HANDLE  
CUCHILLO DE MANTEQUILLA HOJA LISA  
19,4 CM - 7 IN<sup>5/8</sup>

154558  
**FOURCHETTE À POISSON**  
FISH FORK  
TENEDOR DE PESCADO  
18,7 CM - 7 IN<sup>3/8</sup>

154561  
**COUTEAU À POISSON**  
FISH KNIFE  
CUCHILLO DE PESCADO  
21,1 CM - 8 IN<sup>5/16</sup>



154001  
**CUILLÈRE À CAFÉ**  
COFFEE/TEA SPOON  
CUCHARA DE CAFÉ  
14,1 CM - 5 IN<sup>2/16</sup>

154577  
**CUILLÈRE À MOKA**  
DEMI TASSE SPOON  
CUCHARA DE MOKA  
11,1 CM - 4 IN<sup>1/8</sup>

190016  
**CUILLÈRE À SODA**  
ICED TEA SPOON  
CUCHARA DE SODA/HELADO  
19 CM - 7 IN<sup>1/2</sup>

154547  
**FOURCHETTE À GÂTEAUX  
COCKTAIL**  
PASTRY/COCKTAIL FORK  
TENEDOR DE PASTEL  
14 CM - 5 IN<sup>1/2</sup>

154563  
**FOURCHETTE DE SERVICE**  
SERVING FORK  
TENEDOR DE SERVICIO/ENSALADA  
25,1 CM - 9 IN<sup>7/8</sup>

154562  
**CUILLÈRE DE SERVICE**  
SERVING SPOON  
CUCHARA DE SERVICIO/ENSALADA  
25,5 CM - 10 IN<sup>1/16</sup>

154566  
**SERVICE À SALADE**  
SALAD SERVING SET  
SET SERVICIO DE ENSALADA  
24,3 CM - 9 IN<sup>9/16</sup>

154552  
**PELLE À TARTE MONOBLOC**  
PASTRY SERVER SOLID HANDLE  
PALA PARA TARTA  
25,3 CM - 9 IN<sup>15/16</sup>

154550  
**LOUCHE**  
SOUP LADLE  
CAZO  
29,7 CM - 11 IN<sup>10/16</sup>



©Patrick ROUGEREAU





226167  
**FOURCHETTE DE TABLE**  
TABLE FORK  
TENEDOR DE MESA  
21 CM - 8 IN<sup>1/4</sup>



226177  
**COUTEAU DE TABLE MONOBLOC LAME SCIE N°1**  
TABLE KNIFE SOLID HANDLE SERRATED N°1  
CUCHILLO DE MESA HOJA SIERRA N°1  
22,8 CM - 9 IN



226176  
**COUTEAU À STEAK MONOBLOC LAME SCIE N°2**  
STEAK KNIFE SOLID HANDLE SERRATED N°2  
CUCHILLO DE STEAK HOJA SIERRA N°2  
22,8 CM - 9 IN



226168  
**CUILLÈRE DE TABLE**  
TABLE/ PASTA SPOON  
CUCHARA DE MESA  
21 CM - 8 IN<sup>1/4</sup>



226172  
**CUILLÈRE À DESSERT**  
DESSERT/SOUP SPOON, OVAL  
CUCHARA DE POSTRE  
18,9 CM - 7 IN<sup>7/16</sup>



226171  
**FOURCHETTE À DESSERT**  
DESSERT/SALAD FORK  
TENEDOR DE POSTRE  
18,9 CM - 7 IN<sup>7/16</sup>



226179  
**COUTEAU À DESSERT MONOBLOC LAME UNIE N°1**  
DESSERT KNIFE SOLID HANDLE N°1  
CUCHILLO DE POSTRE HOJA LISA N°1  
20,5 CM - 8 IN<sup>1/16</sup>



226178  
**COUTEAU À DESSERT MONOBLOC LAME UNIE N°2**  
DESSERT KNIFE SOLID HANDLE N°2  
CUCHILLO DE POSTRE HOJA LISA N°2  
20,5 CM - 8 IN<sup>1/16</sup>



226171  
**FOURCHETTE À POISSON**  
FISH FORK  
TENEDOR DE PESCADO  
18,9 CM - 7 IN<sup>7/16</sup>

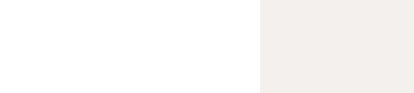

226173  
**COUTEAU À POISSON/ GOURMET**  
GOURMET/FISH KNIFE  
CUCHILLO DE PESCADO  
21 CM - 8 IN<sup>1/4</sup>



226169  
**CUILLÈRE À CAFÉ**  
COFFEE/TEA SPOON  
CUCHARA DE CAFÉ  
14,5 CM - 5 IN<sup>17/16</sup>



226170  
**CUILLÈRE À MOKA**  
DEMI TASSE SPOON  
CUCHARA DE MOKA  
11,6 CM - 4 IN<sup>9/16</sup>

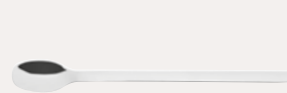

226175  
**CUILLÈRE À SODA**  
ICED TEA SPOON  
CUCHARA DE SODA/HELADO  
19 CM - 7 IN<sup>1/2</sup>



226174  
**FOURCHETTE À GÂTEAUX/ COCKTAIL**  
PASTRY/COCKTAIL FORK  
TENEDOR DE PASTEL  
14,5 CM - 5 IN<sup>17/16</sup>



190424  
**FOURCHETTE À HÙÎTRES**  
OYSTER FORK  
TENEDOR DE OSTRAS  
14,1 CM - 5 IN<sup>9/16</sup>



197522  
**FOURCHETTE DE SERVICE**  
SERVING FORK  
TENEDOR DE SERVICIO/ENSALADA  
26,6 CM - 10 IN<sup>1/2</sup>



197523  
**CUILLÈRE DE SERVICE**  
SERVING SPOON  
CUCHARA DE SERVICIO/ENSALADA  
27 CM - 10 IN<sup>5/8</sup>



197525  
**SERVICE À SALADE**  
SALAD SERVING SET  
SET SERVICIO DE ENSALADA  
30 CM - 11 IN<sup>13/16</sup>



197527  
**PELLE À TARTE MONOBLOC**  
PASTRY SERVER SOLID HANDLE  
PALA PARA TARTA  
25,1 CM - 9 IN<sup>7/8</sup>



153193  
**LOUCHE**  
SOUP LADLE  
CAZO  
29,7 CM - 11 IN<sup>17/16</sup>



154606  
**LOUCHE À SAUCE**  
SAUCE LADLE  
CAZO PARA SALSA  
18,5 CM - 7 IN<sup>57/16</sup>

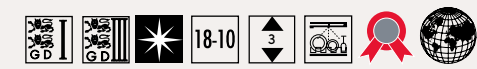

LES COUVERTS  
FLATWARE - CUBIERTOS





163580  
**FOURCHETTE DE TABLE**  
TABLE FORK  
TENEDOR DE MESA  
20,9 CM - 8 IN<sup>3/16</sup>



189973  
**CUILLÈRE À SODA**  
ICED TEA SPOON  
CUCHARA DE SODA/HELADO  
19 CM - 7 IN<sup>1/2</sup>



189969  
**COUTEAU DE TABLE  
MONOBLOC LAME SCIE**  
TABLE KNIFE SOLID HANDLE SERRATED  
CUCHILLO DE MESA HOJA SIERRA  
22,9 CM - 9 IN



164705  
**FOURCHETTE À GÂTEAUX/  
COCKTAIL**  
PASTRY/COCKTAIL FORK  
TENEDOR DE PASTEL  
14,4 CM - 5 IN<sup>11/16</sup>



207189  
**COUTEAU À STEAK  
MONOBLOC LAME SCIE**  
STEAK KNIFE SOLID HANDLE SERRATED  
CUCHILLO DE STEAK HOJA SIERRA  
23,6 CM - 9 IN<sup>5/16</sup>



189974  
**FOURCHETTE À HÙÎTRES**  
OYSTER FORK  
TENEDOR DE OSTRAS  
14,1 CM - 5 IN<sup>9/16</sup>



163579  
**CUILLÈRE DE TABLE**  
TABLE/PASTA SPOON  
CUCHARA DE MESA  
21,1 CM - 8 IN<sup>5/16</sup>



162728  
**FOURCHETTE /PIQUE À  
ESCARGOTS/COCKTAIL**  
COCKTAIL, SNAIL FORK  
TENEDOR DE CARACOL/COCKTAIL  
10,8 CM - 4 IN<sup>1/4</sup>



164713  
**CUILLÈRE À DESSERT**  
DESSERT/SOUP SPOON, OVAL  
CUCHARA DE POSTRE  
19 CM - 7 IN<sup>1/2</sup>



162730  
**CURETTE À CRUSTACÉS**  
SEAFOOD SCRAPER  
RASQUETA PARA CANGREJO  
19,1 CM - 7 IN<sup>1/2</sup>



164714  
**FOURCHETTE À DESSERT**  
DESSERT/SALAD FORK  
TENEDOR DE POSTRE  
18,9 CM - 7 IN<sup>7/16</sup>



231218  
**FOURCHETTE DE SERVICE**  
SERVING FORK  
TENEDOR DE SERVICIO/ENSALADA  
26,6 CM - 10 IN<sup>1/2</sup>



210627  
**COUTEAU À DESSERT  
MONOBLOC LAME SCIE**  
DESSERT KNIFE SOLID HANDLE  
SERRATED  
CUCHILLO DE POSTRE HOJA SIERRA  
20,6 CM - 8 IN<sup>1/8</sup>



231219  
**CUILLÈRE DE SERVICE**  
SERVING SPOON  
CUCHARA DE SERVICIO/ENSALADA  
26,6 CM - 10 IN<sup>1/2</sup>



189971  
**COUTEAU À BEURRE  
MONOBLOC LAME UNIE**  
BUTTER KNIFE SOLID HANDLE  
CUCHILLO DE MANTEQUILLA HOJA LISA  
18,8 CM - 7 IN<sup>3/8</sup>



231221  
**PELLE À TARTE MONOBLOC**  
PASTRY SERVER SOLID HANDLE  
PALA PARA TARTA  
25,2 CM - 9 IN<sup>15/16</sup>



164708  
**FOURCHETTE À POISSON**  
FISH FORK  
TENEDOR DE PESCADO  
18,9 CM - 7 IN<sup>7/16</sup>



231220  
**LOUCHE**  
SOUP LADLE  
CAZO  
29 CM - 11 IN<sup>7/16</sup>



164709  
**COUTEAU À POISSON/  
GOURMET**  
GOURMET/FISH KNIFE  
CUCHILLO DE PESCADO  
21 CM - 8 IN<sup>1/4</sup>



163581  
**CUILLÈRE À CAFÉ**  
COFFEE/TEA SPOON  
CUCHARA DE CAFÉ  
14,3 CM - 5 IN<sup>5/8</sup>



164715  
**CUILLÈRE À MOKA/TOUILLETTE**  
DEMI TASSE SPOON  
CUCHARA DE MOKA  
11 CM - 4 IN<sup>3/16</sup>



DEGRÈNE

©Patrick ROUGEREAU





111894  
**FOURCHETTE DE TABLE**  
TABLE FORK  
TENEDOR DE MESA  
20,4 CM - 8 IN<sup>7/16</sup>



111921  
**COÛTEAU DE TABLE MONOBLOC LAME SCIE**  
TABLE KNIFE SOLID HANDLE SERRATED  
CUCHILLO DE MESA HOJA SIERRA  
23 CM - 9 IN<sup>1/16</sup>



111891  
**CUILLÈRE DE TABLE**  
TABLE/ PASTA SPOON  
CUCHARA DE MESA  
20,4 CM - 8 IN<sup>7/16</sup>



111904  
**CUILLÈRE À DESSERT**  
DESSERT/SOUP SPOON, OVAL  
CUCHARA DE POSTRE  
18 CM - 7 IN<sup>7/16</sup>



111907  
**FOURCHETTE À DESSERT**  
DESSERT/SALAD FORK  
TENEDOR DE POSTRE  
18 CM - 7 IN<sup>7/16</sup>



210631  
**COÛTEAU À DESSERT MONOBLOC LAME SCIE**  
DESSERT KNIFE SOLID HANDLE SERRATED  
CUCHILLO DE POSTRE HOJA SIERRA  
20,3 CM - 8 IN



111897  
**CUILLÈRE À CAFÉ**  
COFFEE/TEA SPOON  
CUCHARA DE CAFÉ  
13,6 CM - 5 IN<sup>3/8</sup>



114437  
**CUILLÈRE À MOKA**  
DEMI TASSE SPOON  
CUCHARA DE MOKA  
11 CM - 4 IN<sup>5/16</sup>

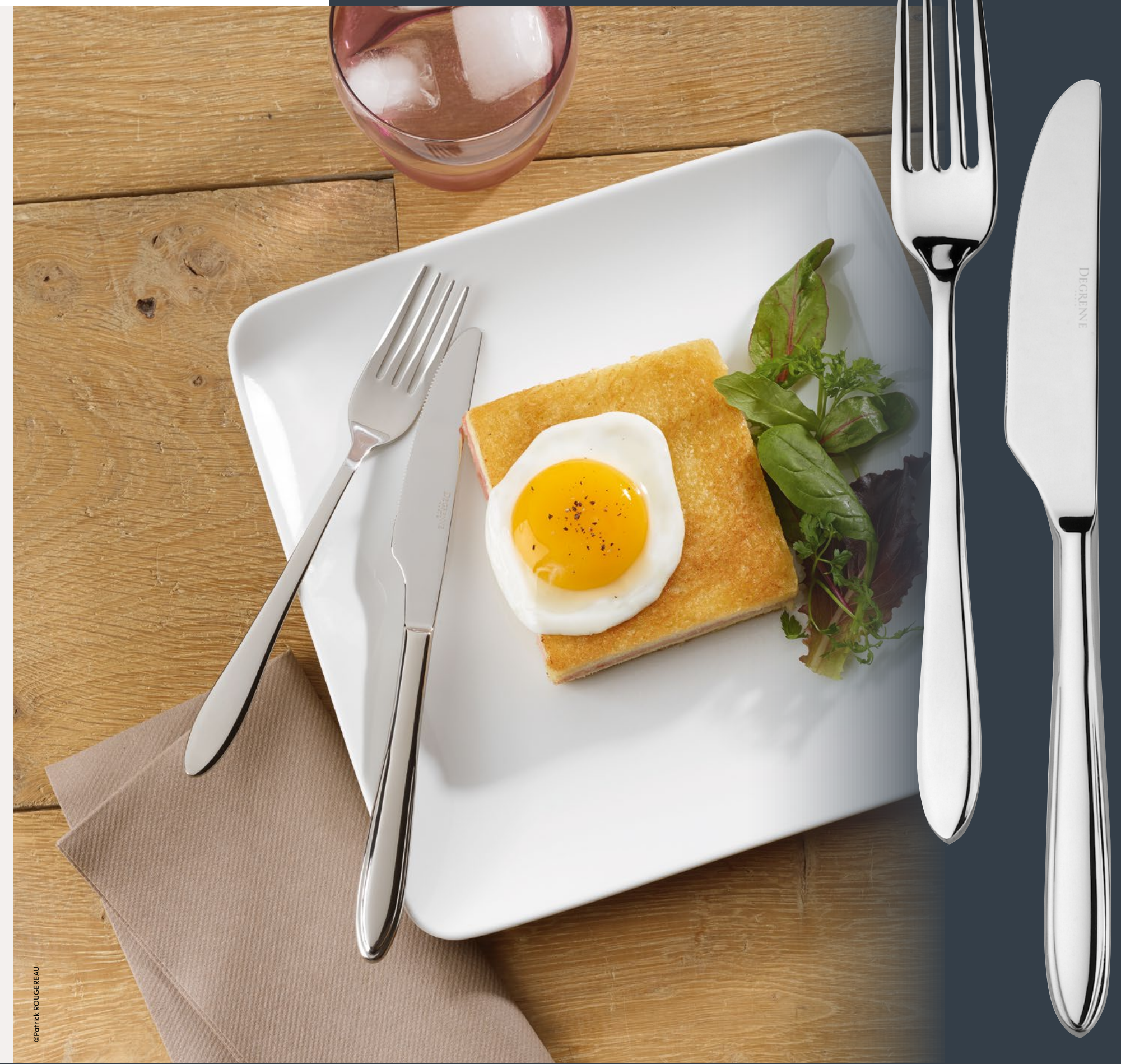

©Patrick ROUGEREAU

LES COUVERTS  
PLATWARE - CUBIERTOS



CARBONE - CARBON - CARBONO

205883  
**FOURCHETTE DE TABLE**  
TABLE FORK  
TENEDOR DE MESA  
21,6 CM - 8 IN<sup>1/2</sup>



205885  
**COUTEAU DE TABLE/STEAK  
LAME SCIE**  
STEAK/TABLE KNIFE SERRATED  
CUCHILLO DE STEAK HOJA SIERRA  
23 CM - 9 IN<sup>1/16</sup>



205884  
**CUILLÈRE DE TABLE**  
TABLE/ PASTA SPOON  
CUCHARA DE MESA  
21,8 CM - 8 IN<sup>3/16</sup>



205886  
**CUILLÈRE À CAFÉ**  
COFFEE/TEA SPOON  
CUCHARA DE CAFÉ  
15,2 CM - 6 IN



ROUGE - RED - ROJO

206782  
**FOURCHETTE DE TABLE**  
TABLE FORK  
TENEDOR DE MESA  
21,6 CM - 8 IN<sup>1/2</sup>



205894  
**COUTEAU DE TABLE/STEAK  
LAME SCIE**  
STEAK/TABLE KNIFE SERRATED  
CUCHILLO DE STEAK HOJA SIERRA  
23 CM - 9 IN<sup>1/16</sup>



206783  
**CUILLÈRE DE TABLE**  
TABLE/ PASTA SPOON  
CUCHARA DE MESA  
21,8 CM - 8 IN<sup>3/16</sup>



206784  
**CUILLÈRE À CAFÉ**  
COFFEE/TEA SPOON  
CUCHARA DE CAFÉ  
15,2 CM - 6 IN



BLANC - WHITE - BLANCO

210661  
**FOURCHETTE DE TABLE**  
TABLE FORK  
TENEDOR DE MESA  
21,6 CM - 8 IN<sup>1/2</sup>



210658  
**COUTEAU DE TABLE/STEAK  
LAME SCIE**  
STEAK/TABLE KNIFE SERRATED  
CUCHILLO DE STEAK HOJA SIERRA  
23 CM - 9 IN<sup>1/16</sup>



210660  
**CUILLÈRE DE TABLE**  
TABLE/ PASTA SPOON  
CUCHARA DE MESA  
21,8 CM - 8 IN<sup>3/16</sup>



210662  
**CUILLÈRE À CAFÉ**  
COFFEE/TEA SPOON  
CUCHARA DE CAFÉ  
15,2 CM - 6 IN



CÈPE - TAUPE - TOPO

226787  
**FOURCHETTE DE TABLE**  
TABLE FORK  
TENEDOR DE MESA  
21,6 CM - 8 IN<sup>1/2</sup>



226789  
**COUTEAU DE TABLE/STEAK  
LAME SCIE**  
STEAK/TABLE KNIFE SERRATED  
CUCHILLO DE STEAK HOJA SIERRA  
23 CM - 9 IN<sup>1/16</sup>



226788  
**CUILLÈRE DE TABLE**  
TABLE/ PASTA SPOON  
CUCHARA DE MESA  
21,8 CM - 8 IN<sup>3/16</sup>



226790  
**CUILLÈRE À CAFÉ**  
COFFEE/TEA SPOON  
CUCHARA DE CAFÉ  
15,2 CM - 6 IN<sup>5/8</sup>



ATOLL - TEAL - VERDE AZULADO

226767  
**FOURCHETTE DE TABLE**  
TABLE FORK  
TENEDOR DE MESA  
21,6 CM - 8 IN<sup>1/2</sup>



226769  
**COUTEAU DE TABLE/STEAK  
LAME SCIE**  
STEAK/TABLE KNIFE SERRATED  
CUCHILLO DE STEAK HOJA SIERRA  
23 CM - 9 IN<sup>1/16</sup>



226768  
**CUILLÈRE DE TABLE**  
TABLE/ PASTA SPOON  
CUCHARA DE MESA  
21,8 CM - 8 IN<sup>3/16</sup>



226770  
**CUILLÈRE À CAFÉ**  
COFFEE/TEA SPOON  
CUCHARA DE CAFÉ  
15,2 CM - 6 IN



BLEU MARIN - STEEL BLUE - AZUL MARINO

226772  
**FOURCHETTE DE TABLE**  
TABLE FORK  
TENEDOR DE MESA  
21,6 CM - 8 IN<sup>1/2</sup>



226774  
**COUTEAU DE TABLE/STEAK  
LAME SCIE**  
STEAK/TABLE KNIFE SERRATED  
CUCHILLO DE STEAK HOJA SIERRA  
23 CM - 9 IN<sup>1/16</sup>



226773  
**CUILLÈRE DE TABLE**  
TABLE/ PASTA SPOON  
CUCHARA DE MESA  
21,8 CM - 8 IN<sup>3/16</sup>



226775  
**CUILLÈRE À CAFÉ**  
COFFEE/TEA SPOON  
CUCHARA DE CAFÉ  
15,2 CM - 6 IN

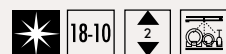

©Patrick ROUGEREAU

DEGRÈNE



# PIÈCES COMPLÉMENTAIRES

# PETIT GOURMET



190018  
**CUILLÈRE À SODA**  
ICED TEA SPOON  
CUCHARA DE SODA/HELADO  
19 CM - 7 IN<sup>1/2</sup>



189973  
**CUILLÈRE À SODA**  
ICED TEA SPOON  
CUCHARA DE SODA/HELADO  
19 CM - 7 IN<sup>1/2</sup>

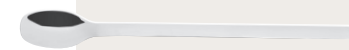

226175  
**CUILLÈRE À SODA**  
ICED TEA SPOON  
CUCHARA DE SODA/HELADO  
19 CM - 7 IN<sup>1/2</sup>



162724  
**CUILLÈRE À AGRUMES**  
CITRUS FRUITS SPOON  
CUCHARA PARA POMELO  
15,3 CM - 6 IN



190424  
**FOURCHETTE À HÙITRES**  
OYSTER FORK  
TENEDOR DE OSTRAS  
14,1 CM - 5 IN<sup>3/16</sup>



189974  
**FOURCHETTE À HÙITRES**  
OYSTER FORK  
TENEDOR DE OSTRAS  
14,1 CM - 5 IN<sup>3/16</sup>

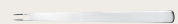

162728  
**FOURCHETTE /PIQUE À  
ESCARGOTS/COCKTAIL**  
COCKTAIL, SNAIL FORK  
TENEDOR DE CARACOL/COCKTAIL  
10,8 CM - 4 IN<sup>1/4</sup>



162730  
**CURETTE À CRUSTACÉS**  
SEAFOOD SCRAPER  
RASQUETA PARA CANGREJO  
19,1 CM - 7 IN<sup>1/2</sup>



154612  
**COUTEAU À BEURRE  
MONOBLOC LAME UNIE**  
BUTTER KNIFE SOLID HANDLE  
CUCHILLO DE MANTEQUILLA HOJA LISA  
19,4 CM - 7 IN<sup>5/8</sup>



189971  
**COUTEAU À BEURRE  
MONOBLOC LAME UNIE**  
BUTTER KNIFE SOLID HANDLE  
CUCHILLO DE MANTEQUILLA HOJA LISA  
18,9 CM - 7 IN<sup>7/16</sup>



159451  
**COUTEAU À STEAK MONOBLOC  
LAME SCIE**  
STEAK KNIFE SOLID HANDLE SERRATED  
CUCHILLO STEAK HOJA SIERRA  
23,5 CM - 9 IN<sup>1/4</sup>



122418  
**COUTEAU À STEAK MONOBLOC  
LAME SCIE**  
STEAK KNIFE SOLID HANDLE SERRATED  
CUCHILLO STEAK HOJA SIERRA  
22,1 CM - 8 IN<sup>11/16</sup>



184492  
**PINCE À CRUSTACÉ**  
SEAFOOD CRACKER  
TENACILLAS PARA CRUSTÁCEOS  
16,5 CM - 6 IN<sup>1/2</sup>



004013  
**PINCE À ESCARGOTS**  
SNAIL TONG  
PINZAS CARACOL/ES  
16 CM - 6 IN<sup>5/16</sup>



204498 101492  
**PINCE À PAIN**  
BREAD TONG  
PINZAS PAN  
23 CM - 9 IN<sup>1/16</sup>



204497 101493  
**PINCE À HOMARD**  
LOBSTER CRACKER  
TENACILLAS PARA  
BOGAVANTE  
18,5 CM - 7 IN<sup>5/16</sup>



204496 101494  
**CISEAUX À GÂTEAUX**  
PASTRY CISSORS/TONG  
PINZAS PARA PASTELES  
20 CM - 7 IN<sup>7/8</sup>



204499 184355  
**PINCE À SERVIR**  
SERVING TONG  
PINZAS PARA SERVIR  
29,5 CM - 11 IN<sup>5/8</sup>



207257 207538  
**FOURCHETTE À DESSERT**  
DESSERT/SALAD FORK  
TENEDOR DE POSTRE  
16,5 CM - 6 IN<sup>1/2</sup>



207259 207540  
**COUTEAU À DESSERT  
MONOBLOC LAME UNIE**  
DESSERT KNIFE SOLID HANDLE  
CUCHILLO DE POSTRE HOJA LISA  
17,7 CM - 6 IN<sup>15/16</sup>



207258 207539  
**CUILLÈRE À DESSERT**  
DESSERT/SOUP SPOON, OVAL  
CUCHARA DE POSTRE  
16,5 CM - 6 IN<sup>1/2</sup>



207256 207537  
**CUILLÈRE À CAFÉ**  
COFFEE/TEA SPOON  
CUCHARA DE CAFÉ  
13,2 CM - 5 IN<sup>1/16</sup>

DES LIGNES DOUCES ET UNE TAILLE ADAPTÉE AUX MAINS DES ENFANTS  
POUR FAIRE DE LEUR REPAS UN MOMENT EXQUIS

SOFT LINES AND A CHILD-FRIENDLY SIZE TO MAKE CHILDREN'S  
MEALTIMES A MAGIC MOMENT

LÍNEAS SUAVES Y UN TAMAÑO ADAPTADO A LAS MANOS DE LOS NIÑOS  
PARA CONVERTIR LA COMIDA EN UN MOMENTO EXQUISITO





## MIRAGE LES ESSENCES



NEW

233848  
**COUTEAU À STEAK MANCHE OLIVIER**  
STEAK KNIFE OLIVE WOOD HANDLE  
CUCHILLO STEAK MANGO DE MADERA DE OLIVO  
23 CM - 9 IN<sup>17/16</sup>



NEW

233853  
**COUTEAU À STEAK MANCHE PICANA**  
STEAK KNIFE PICANA HANDLE  
CUCHILLO STEAK MANGO DE PICANA  
23 CM - 9 IN<sup>17/16</sup>

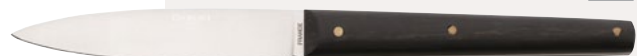

NEW

233851  
**COUTEAU À STEAK MANCHE ÉBÈNE**  
STEAK KNIFE EBONY HANDLE  
CUCHILLO STEAK MANGO DE ÉBANO  
23 CM - 9 IN<sup>17/16</sup>

## MIRAGE



226261  
**COUTEAU DE TABLE/ STEAK LAME UNIE ANTHRACITE**  
BLACK TABLE STEAK KNIFE  
CUCHILLO STEAK NEGRO  
23 CM - 9 IN<sup>17/16</sup>



226263  
**COUTEAU DE TABLE/ STEAK LAME UNIE BLANC**  
WHITE TABLE STEAK KNIFE  
CUCHILLO STEAK BLANCO  
23 CM - 9 IN<sup>17/16</sup>

## LAGUIOLE



232249  
**COUTEAU LAGUIOLE - CORNE NOIRE - MITRE INOX**  
LAGUIOLE STEAK KNIFE BLACK HORN - STEEL BOLSTER  
LAGUIOLE CUCHILLO STEAK CUERNO - MITRA ACERO  
23 CM - 9 IN<sup>17/16</sup>



232251  
**COUTEAU LAGUIOLE - CORNE CLAIRE - MITRE LAITON**  
LAGUIOLE STEAK KNIFE LIGHT HORN - BRASS BOLSTER  
LAGUIOLE CUCHILLO STEAK CUERNO CLARO - MITRA LATON  
23 CM - 9 IN<sup>17/16</sup>



232253  
**COUTEAU LAGUIOLE - IVOIRINE - MITRE INOX**  
LAGUIOLE STEAK KNIFE IVORY COLOR - STEEL BOLSTER  
LAGUIOLE CUCHILLO STEAK COLOR MARFIL - MITRA ACERO  
23 CM - 9 IN<sup>17/16</sup>



232255  
**COUTEAU LAGUIOLE - OLIVIER - MITRE LAITON**  
LAGUIOLE STEAK KNIFE OLIVE WOOD - BRASS BOLSTER  
LAGUIOLE CUCHILLO STEAK OLIVO - MITRA LATON  
23 CM - 9 IN<sup>17/16</sup>

## CAPUCIN



232243  
**COUTEAU À STEAK CAPUCIN NOIR**  
CAPUCIN STEAK KNIFE - BLACK  
CAPUCIN CUCHILLO STEAK - NEGRO  
22,6 CM - 8 IN<sup>7/8</sup>



232245  
**COUTEAU À STEAK CAPUCIN IVOIRINE**  
CAPUCIN STEAK KNIFE - IVORY COLOR  
CAPUCIN CUCHILLO STEAK - COLOR MARFIL  
22,6 CM - 8 IN<sup>7/8</sup>



232247  
**COUTEAU À STEAK CAPUCIN ROUGE**  
CAPUCIN STEAK KNIFE - RED  
CAPUCIN CUCHILLO STEAK - ROJO  
22,6 CM - 8 IN<sup>7/8</sup>



© Patrick ROUGEREAU





# COLLECTIONS CLASSIQUES

**NORMANDY**  
232963 - FOURCHETTE DE TABLE - TABLE FORK - TENEDOR DE MESA P.125  
232966 - COUTEAU DE TABLE MONOBLOC LAME SCIE - TABLE KNIFE SOLID HANDLE  
SERRATED - CUCHILLO DE MESA HOJA SIERRA  
232964 - CUILLÈRE DE TABLE - TABLE SPOON - CUCHARA DE MESA  
232965 - CUILLÈRE À CAFÉ - COFFEE/TEA SPOON - CUCHARA DE CAFÉ





126556  
**FOURCHETTE DE TABLE**  
TABLE FORK  
TENEDOR DE MESA  
20,2 CM - 7 IN<sup>15/16</sup>



126565  
**COUTEAU DE TABLE MONOCOQUE MANCHE ORFÈVRE LAME UNIE**  
TABLE KNIFE HOLLOW HANDLE  
CUCHILLO DE MESA ENMANGADO  
HOJA LISA  
23 CM - 9 IN<sup>7/16</sup>



130332  
**COUTEAU DE TABLE MONOCOQUE MANCHE ORFÈVRE LAME SCIE**  
TABLE KNIFE HOLLOW HANDLE SERRATED  
CUCHILLO DE MESA ENMANGADO  
HOJA SIERRA  
23 CM - 9 IN<sup>7/16</sup>



126553  
**CUILLÈRE DE TABLE**  
TABLE / PASTA SPOON  
CUCHARA DE MESA  
20,5 CM - 8 IN<sup>1/16</sup>



126569  
**CUILLÈRE À DESSERT**  
DESSERT/SOUP SPOON, OVAL  
CUCHARA DE POSTRE  
18 CM - 7 IN<sup>7/16</sup>



126572  
**FOURCHETTE À DESSERT**  
DESSERT/SALAD FORK  
TENEDOR DE POSTRE  
18 CM - 7 IN<sup>7/16</sup>



126575  
**COUTEAU À DESSERT MONOCOQUE MANCHE ORFÈVRE LAME UNIE**  
DESSERT KNIFE HOLLOW HANDLE  
CUCHILLO DE POSTRE ENMANGADO  
HOJA LISA  
20,5 CM - 8 IN<sup>1/16</sup>



154528  
**COUTEAU À BEURRE MONOCOQUE MANCHE ORFÈVRE LAME UNIE**  
BUTTER KNIFE HOLLOW HANDLE  
CUCHILLO DE MANTEQUILLA  
ENMANGADO HOJA LISA  
18,8 CM - 7 IN<sup>3/8</sup>



126578  
**FOURCHETTE À POISSON**  
FISH FORK  
TENEDOR DE PESCADO  
18 CM - 7 IN<sup>7/16</sup>



126581  
**COUTEAU À POISSON**  
FISH KNIFE  
CUCHILLO DE PESCADO  
20,1 CM - 7 IN<sup>15/16</sup>



126559  
**CUILLÈRE À CAFÉ**  
COFFEE/TEA SPOON  
CUCHARA DE CAFÉ  
13,9 CM - 5 IN<sup>1/2</sup>



155452  
**CUILLÈRE À MOKA**  
DEMI TASSE SPOON  
CUCHARA DE MOKA  
11,1 CM - 4 IN<sup>3/8</sup>



126591  
**FOURCHETTE DE SERVICE**  
SERVING FORK  
TENEDOR DE SERVICIO/ENSALADA  
24,8 CM - 9 IN<sup>3/4</sup>



126589  
**CUILLÈRE DE SERVICE**  
SERVING SPOON  
CUCHARA DE SERVICIO/ENSALADA  
25 CM - 9 IN<sup>13/16</sup>



126587  
**PELLE À TARTE MANCHE ORFÈVRE**  
PASTRY SERVER HOLLOW HANDLE  
PALA PARA TARTA ENMANGADO  
24 CM - 9 IN<sup>7/16</sup>















126595  
**LOUCHE À SAUCE**  
SAUCE LADLE  
CAZO PARA SALSA  
17 CM - 6 IN<sup>1/16</sup>







	232963 <b>FOURCHETTE DE TABLE</b> TABLE FORK TENEDOR DE MESA 20,3 CM – 8 IN
	232966 <b>COUTEAU DE TABLE MONOBLOC LAME SCIE</b> TABLE KNIFE SOLID HANDLE SERRATED CUCHILLO DE MESA HOJA SIERRA 24 CM – 9 IN <sup>7/8</sup>
	232964 <b>CUILLÈRE DE TABLE</b> TABLE SPOON CUCHARA DE MESA 20,3 CM – 8 IN
	234654 <b>CUILLÈRE À SOUPE ANGLAISE</b> BOUILLON SPOON CUCHARA DE CONSOMÉ 17,6 CM – 6 IN <sup>5/16</sup>
	234659 <b>CUILLÈRE À DESSERT</b> DESSERT SPOON CUCHARA DE POSTRE 18,2 CM – 7 IN <sup>3/16</sup>
	234655 <b>CUILLÈRE GOURMET</b> GOURMET SPOON CUCHARA GOURMET 18,2 CM – 7 IN <sup>3/16</sup>
	234656 <b>FOURCHETTE À DESSERT</b> DESSERT FORK TENEDOR DE POSTRE 18,3 CM – 7 IN <sup>3/16</sup>
	234657 <b>COUTEAU À DESSERT MONOBLOC LAME UNIE</b> DESSERT KNIFE SOLID HANDLE CUCHILLO DE POSTRE 21,5 CM – 8 IN <sup>7/16</sup>
	234658 <b>COUTEAU À BEURRE MONOBLOC LAME UNIE</b> BUTTER KNIFE SOLID HANDLE CUCHILLO MANTEQUILLA HOJA LISA 18,5 CM – 7 IN <sup>5/16</sup>
	232965 <b>CUILLÈRE À CAFÉ</b> COFFEE/TEA SPOON CUCHARA DE CAFÉ 14 CM – 5 IN <sup>1/2</sup>
	234660 <b>CUILLÈRE À MOKA</b> DEMI TASSE SPOON CUCHARA DE MOKA 11,1 CM – 4 IN <sup>3/8</sup>
	234661 <b>FOURCHETTE À GÂTEAUX/ COCKTAIL</b> PASTRY/COCKTAIL FORK TENEDOR DE PASTEL 14 CM – 5 IN <sup>1/2</sup>

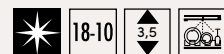

©Patrick ROJGEREAU







205533  
**FOURCHETTE DE TABLE**  
TABLE FORK  
TENEDOR DE MESA  
20,7 CM - 8 IN<sup>1/8</sup>



199160  
**COUTEAU DE TABLE MONOCOQUE MANCHE ORFÈVRE LAME SCIE**  
TABLE KNIFE HOLLOW HANDLE SERRATED  
CUCHILLO DE MESA ENMANGADO HOJA SIERRA  
23,3 CM - 9 IN<sup>3/16</sup>



215601  
**COUTEAU DE TABLE MONOCOQUE MANCHE ORFÈVRE LAME SCIE RONDE**  
TABLE KNIFE HOLLOW HANDLE SERRATED ROUNDED BLADE  
CUCHILLO DE MESA ENMANGADO REDONDA HOJA SIERRA  
23,3 CM - 9 IN<sup>3/16</sup>



205534  
**CUILLÈRE DE TABLE**  
TABLE/ PASTA SPOON  
CUCHARA DE MESA  
20,7 CM - 8 IN<sup>1/8</sup>



205535  
**CUILLÈRE À SOUPE ANGLAISE**  
BOUILLON SPOON, ROUND  
CUCHARA DE CONSOMÉ  
17,7 CM - 6 IN<sup>15/16</sup>



205539  
**CUILLÈRE À DESSERT**  
DESSERT/SOUP SPOON, OVAL  
CUCHARA DE POSTRE  
18,2 CM - 7 IN<sup>3/16</sup>



205538  
**FOURCHETTE À DESSERT**  
DESSERT/SALAD FORK  
TENEDOR DE POSTRE  
18,2 CM - 7 IN<sup>3/16</sup>



199164  
**COUTEAU À DESSERT MONOCOQUE MANCHE ORFÈVRE LAME UNIE**  
DESSERT KNIFE HOLLOW HANDLE  
CUCHILLO DE POSTRE ENMANGADO HOJA LISA  
20,6 CM - 8 IN<sup>1/8</sup>



215602  
**COUTEAU À DESSERT MANCHE ORFÈVRE LAME UNIE RONDE**  
DESSERT KNIFE HOLLOW HANDLE ROUNDED BLADE  
CUCHILLO DE POSTRE ENMANGADO REDONDA HOJA LISA  
20,6 CM - 8 IN<sup>1/8</sup>



199170  
**COUTEAU À BEURRE MONOCOQUE MANCHE ORFÈVRE LAME UNIE**  
BUTTER KNIFE HOLLOW HANDLE  
CUCHILLO DE MANTEQUILLA ENMANGADO HOJA LISA  
18,5 CM - 7 IN<sup>5/16</sup>



205538  
**FOURCHETTE À POISSON**  
FISH FORK  
TENEDOR DE PESCADO  
18,2 CM - 7 IN<sup>3/16</sup>



205537  
**COUTEAU À POISSON**  
FISH KNIFE  
CUCHILLO DE PESCADO  
21,2 CM - 8 IN<sup>5/16</sup>



199159  
**CUILLÈRE À CAFÉ**  
COFFEE/TEA SPOON  
CUCHARA DE CAFÉ  
14,1 CM - 5 IN<sup>9/16</sup>



199161  
**CUILLÈRE À MOKA**  
DEMI TASSE SPOON  
CUCHARA DE MOKA  
11,2 CM - 4 IN<sup>7/16</sup>



199169  
**CUILLÈRE À SODA**  
ICED TEA SPOON  
CUCHARA DE SODA/HELADO  
18,8 CM - 7 IN<sup>3/8</sup>



199167  
**FOURCHETTE À GÂTEAUX**  
PASTRY FORK  
TENEDOR DE PASTEL  
14,2 CM - 5 IN<sup>9/16</sup>



199172  
**FOURCHETTE DE SERVICE**  
SERVING FORK  
TENEDOR DE SERVICIO/ENSALADA  
25 CM - 9 IN<sup>13/16</sup>



199171  
**CUILLÈRE DE SERVICE**  
SERVING SPOON  
CUCHARA DE SERVICIO/ENSALADA  
25 CM - 9 IN<sup>13/16</sup>



199173  
**PELLE À TARTE MONOBLOC**  
PASTRY SERVER SOLID HANDLE  
PALA PARA TARTA  
23,9 CM - 9 IN<sup>7/16</sup>



199174  
**LOUCHE**  
SOUP LADLE  
CAZO  
30,2 CM - 11 IN<sup>7/8</sup>

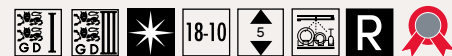





126077  
**FOURCHETTE DE TABLE**  
TABLE FORK  
TENEDOR DE MESA  
20,8 CM - 8 IN<sup>3/16</sup>



190643  
**COUTEAU DE TABLE MONOBLOC LOURD MANCHE DROIT LAME SCIE**  
TABLE KNIFE SOLID HANDLE SERRATED  
CUCHILLO DE MESA PESADO  
RECTO MANGO HOJA SIERRA  
24,6 CM - 9 IN<sup>17/16</sup>



130140  
**COUTEAU DE TABLE MONOCOQUE MANCHE ORFÈVRE DROIT LAME SCIE**  
TABLE KNIFE HOLLOW HANDLE SERRATED  
CUCHILLO DE MESA ENMANGADO RECTO  
MANGO HOJA SIERRA  
24,6 CM - 9 IN<sup>17/16</sup>



127654  
**COUTEAU À STEAK MONOCOQUE MANCHE ORFÈVRE DROIT LAME SCIE**  
STEAK KNIFE HOLLOW HANDLE SERRATED  
CUCHILLO DE STEAK ENMANGADO  
HOJA SIERRA  
23,9 CM - 9 IN<sup>7/16</sup>



126074  
**CUILLÈRE DE TABLE**  
TABLE/ PASTA SPOON  
CUCHARA DE MESA  
20,8 CM - 8 IN<sup>3/16</sup>



127651  
**CUILLÈRE À SOUPE ANGLAISE**  
BOUILLON SPOON, ROUND  
CUCHARA DE CONSOMÉ  
17,4 CM - 6 IN<sup>7/8</sup>



126090  
**CUILLÈRE À DESSERT**  
DESSERT/SOUP SPOON, OVAL  
CUCHARA DE POSTRE  
18 CM - 7 IN<sup>1/16</sup>



126093  
**FOURCHETTE À DESSERT**  
DESSERT/SALAD FORK  
TENEDOR DE POSTRE  
17,8 CM - 7 IN



190644  
**COUTEAU À DESSERT MONOBLOC LOURD MANCHE DROIT LAME SCIE**  
DESSERT KNIFE SOLID HANDLE SERRATED  
CUCHILLO DE POSTRE PESADO  
RECTO MANGO HOJA SIERRA  
20,5 CM - 8 IN<sup>1/16</sup>



126096  
**COUTEAU À DESSERT MONOCOQUE MANCHE ORFÈVRE LAME UNIE**  
DESSERT KNIFE HOLLOW HANDLE  
CUCHILLO DE POSTRE RECTO MANGO  
ENMANGADO HOJA LISA  
20,5 CM - 8 IN<sup>1/16</sup>



190417  
**COUTEAU À BEURRE MONOBLOC LOURD MANCHE DROIT LAME UNIE**  
BUTTER KNIFE SOLID HANDLE  
CUCHILLO DE MANTEQUILLA PESADO  
RECTO MANGO HOJA LISA  
18,7 CM - 7 IN<sup>3/8</sup>



129344  
**COUTEAU À BEURRE MONOCOQUE MANCHE DROIT LAME UNIE**  
BUTTER KNIFE SOLID HANDLE  
CUCHILLO DE MANTEQUILLA  
ENMANGADO HOJA LISA  
18,7 CM - 7 IN<sup>3/8</sup>



126099  
**FOURCHETTE À POISSON**  
FISH FORK  
TENEDOR DE PESCADO  
17,7 CM - 6 IN<sup>5/16</sup>



126102  
**COUTEAU À POISSON**  
FISH KNIFE  
CUCHILLO DE PESCADO  
19,9 CM - 7 IN<sup>13/16</sup>



129958  
**CUILLÈRE À SAUCE GOURMET**  
GOURMET/SAUCE SPOON  
CUCHARA PARA SALSA  
17,9 CM - 7 IN<sup>17/16</sup>



126080  
**CUILLÈRE À CAFÉ**  
COFFEE/TEA SPOON  
CUCHARA DE CAFÉ  
14 CM - 5 IN<sup>1/2</sup>



126105  
**CUILLÈRE À MOKA**  
DEMI TASSE SPOON  
CUCHARA DE MOKA  
11 CM - 4 IN<sup>5/16</sup>



130146  
**CUILLÈRE À SODA**  
ICED TEA SPOON  
CUCHARA DE SODA/HELADO  
18,2 CM - 7 IN<sup>3/16</sup>



126108  
**FOURCHETTE À GÂTEAUX/ COCKTAIL**  
PASTRY/COCKTAIL FORK  
TENEDOR DE PASTEL  
13,8 CM - 5 IN<sup>7/16</sup>



190418  
**FOURCHETTE À HUITRES**  
OYSTER FORK  
TENEDOR DE OSTRAS  
13 CM - 5 IN<sup>1/8</sup>

**PIECES DE SERVICE**  
SERVING PIECES  
SET SERVICIO  
**VERLAINE**  
P.138-139

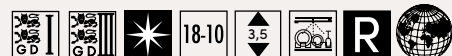





182968  
**FOURCHETTE DE TABLE**  
TABLE FORK  
TENEDOR DE MESA  
20,8 CM - 8 IN<sup>3/16</sup>



186279  
**COUTEAU À BEURRE  
MONOCOQUE MANCHE  
ORFÈVRE LAME UNIE**  
BUTTER KNIFE HOLLOW HANDLE  
CUCHILLO DE MANTEQUILLA  
ENMANGADO HOJA LISA  
18,7 CM - 7 IN<sup>3/8</sup>



182972  
**FOURCHETTE À POISSON**  
FISH FORK  
TENEDOR DE PESCADO  
17,7 CM - 6 IN<sup>5/16</sup>



182973  
**COUTEAU À POISSON**  
FISH KNIFE  
CUCHILLO DE PESCADO  
19,9 CM - 7 IN<sup>3/16</sup>



186277  
**CUILLÈRE À SAUCE  
GOURMET**  
GOURMET/SAUCE SPOON  
CUCHARA PARA SALSA  
17,9 CM - 7 IN<sup>1/16</sup>



182969  
**CUILLÈRE À CAFÉ**  
COFFEE/TEA SPOON  
CUCHARA DE CAFÉ  
14 CM - 5 IN<sup>1/2</sup>



182976  
**CUILLÈRE À MOKA**  
DEMI TASSE SPOON  
CUCHARA DE MOKA  
11 CM - 4 IN<sup>5/16</sup>



186275  
**CUILLÈRE À SODA**  
ICED TEA SPOON  
CUCHARA DE SODA/HELADO  
18,2 CM - 7 IN<sup>3/16</sup>



186274  
**FOURCHETTE À GÂTEAUX/  
COCKTAIL**  
PASTRY/COCKTAIL FORK  
TENEDOR DE PASTEL  
13,8 CM - 5 IN<sup>7/16</sup>



190681  
**FOURCHETTE À HUÎTRES**  
OYSTER FORK  
TENEDOR DE OSTRAS  
13 CM - 5 IN<sup>1/8</sup>



183803  
**FOURCHETTE DE SERVICE**  
SERVING FORK  
TENEDOR DE SERVICIO/ENSALADA  
24,8 CM - 9 IN<sup>3/4</sup>



183802  
**CUILLÈRE DE SERVICE**  
SERVING SPOON  
CUCHARA DE SERVICIO/ENSALADA  
25 CM - 9 IN<sup>13/16</sup>



182970  
**COUTEAU DE TABLE  
MONOCOQUE MANCHE  
ORFÈVRE LAME SCIE**  
TABLE KNIFE HOLLOW HANDLE SERRATED  
CUCHILLO DE MESA ENMANGADO  
HOJA SIERRA  
24,6 CM - 9 IN<sup>11/16</sup>



186278  
**COUTEAU À STEAK  
MONOCOQUE MANCHE  
ORFÈVRE LAME SCIE**  
STEAK KNIFE HOLLOW HANDLE SERRATED  
CUCHILLO DE STEAK ENMANGADO  
HOJA SIERRA  
23,9 CM - 9 IN<sup>7/16</sup>



182967  
**CUILLÈRE DE TABLE**  
TABLE/PASTA SPOON  
CUCHARA DE MESA  
20,8 CM - 8 IN<sup>3/16</sup>



186276  
**CUILLÈRE À SOUPE ANGLAISE**  
BOUILLON SPOON, ROUND  
CUCHARA DE CONSOMÉ  
17,4 CM - 6 IN<sup>7/8</sup>



182974  
**CUILLÈRE À DESSERT**  
DESSERT/SOUP SPOON, OVAL  
CUCHARA DE POSTRE  
18 CM - 7 IN<sup>1/16</sup>



182975  
**FOURCHETTE À DESSERT**  
DESSERT/SALAD FORK  
TENEDOR DE POSTRE  
17,8 CM - 7 IN



182971  
**COUTEAU À DESSERT  
MONOCOQUE MANCHE  
ORFÈVRE LAME UNIE**  
DESSERT KNIFE HOLLOW HANDLE  
CUCHILLO DE POSTRE  
ENMANGADO HOJA LISA  
20,5 CM - 8 IN<sup>1/16</sup>

L'ABUS D'ALCOOL EST DANGEREUX POUR LA SANTÉ  
DEGRENNE PROMOTES RESPONSIBLE DRINKING AND DISCOURAGES ALCOHOL MISUSE  
EL ABUSO DE ALCOHOL ES PELIGROSO PARA LA SALUD

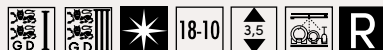





127442  
**FOURCHETTE DE TABLE**  
TABLE FORK  
TENEDOR DE MESA  
20,8 CM - 8 IN<sup>3/16</sup>



226578  
**COUTEAU DE TABLE MONOBLOC LOURD LAME SCIE**  
TABLE KNIFE SOLID HANDLE SERRATED  
CUCHILLO DE MESA PESADO  
HOJA SIERRA  
24,6 CM - 9 IN<sup>17/16</sup>



139158  
**COUTEAU DE TABLE MONOCOQUE MANCHE ORFÈVRE LAME SCIE**  
TABLE KNIFE HOLLOW HANDLE SERRATED  
CUCHILLO DE MESA ENMANGADO  
HOJA SIERRA  
24,6 CM - 9 IN<sup>17/16</sup>



128841  
**COUTEAU À STEAK MONOCOQUE MANCHE ORFÈVRE LAME SCIE**  
STEAK KNIFE HOLLOW HANDLE SERRATED  
CUCHILLO DE STEAK ENMANGADO  
HOJA SIERRA  
23,9 CM - 9 IN<sup>7/16</sup>



127439  
**CUILLÈRE DE TABLE**  
TABLE/ PASTA SPOON  
CUCHARA DE MESA  
20,8 CM - 8 IN<sup>3/16</sup>



130273  
**CUILLÈRE À SOUPE ANGLAISE**  
BOUILLON SPOON, ROUND  
CUCHARA DE CONSOMÉ  
17,4 CM - 6 IN<sup>7/8</sup>



127464  
**CUILLÈRE À DESSERT**  
DESSERT/SOUP SPOON, OVAL  
CUCHARA DE POSTRE  
18 CM - 7 IN<sup>1/16</sup>



127467  
**FOURCHETTE À DESSERT**  
DESSERT/SALAD FORK  
TENEDOR DE POSTRE  
17,8 CM - 7 IN



226579  
**COUTEAU À DESSERT MONOBLOC LOURD LAME UNIE**  
DESSERT KNIFE SOLID HANDLE  
CUCHILLO DE POSTRE PESADO  
HOJA LISA  
21,1 CM - 8 IN<sup>5/16</sup>



127470  
**COUTEAU À DESSERT MONOCOQUE MANCHE ORFÈVRE LAME UNIE**  
DESSERT KNIFE HOLLOW HANDLE  
CUCHILLO DE POSTRE  
ENMANGADO HOJA LISA  
20,5 CM - 8 IN<sup>1/16</sup>



226580  
**COUTEAU À BEURRE MONOBLOC LOURD LAME UNIE**  
BUTTER KNIFE HEAVY SOLID HANDLE  
CUCHILLO DE MANTEQUILLA  
PESADO HOJA LISA  
19 CM - 7 IN<sup>1/2</sup>



122769  
**COUTEAU À BEURRE MONOCOQUE MANCHE ORFÈVRE LAME UNIE**  
BUTTER KNIFE HOLLOW HANDLE  
CUCHILLO DE MANTEQUILLA  
ENMANGADO HOJA LISA  
18,7 CM - 7 IN<sup>3/8</sup>



127473  
**FOURCHETTE À POISSON**  
FISH FORK  
TENEDOR DE PESCADO  
17,7 CM - 6 IN<sup>5/16</sup>



127477  
**COUTEAU À POISSON**  
FISH KNIFE  
CUCHILLO DE PESCADO  
19,9 CM - 7 IN<sup>13/16</sup>



130542  
**CUILLÈRE À SAUCE GOURMET**  
GOURMET SPOON  
CUCHARA PARA SALSA  
17,9 CM - 7 IN<sup>7/16</sup>



127455  
**CUILLÈRE À CAFÉ**  
COFFEE/TEA SPOON  
CUCHARA DE CAFÉ  
14 CM - 5 IN<sup>1/2</sup>



127479  
**CUILLÈRE À MOKA**  
DEMI TASSE SPOON  
CUCHARA DE MOKA  
11 CM - 4 IN<sup>5/16</sup>



127482  
**FOURCHETTE À GÂTEAUX/ COCKTAIL**  
PASTRY/COCKTAIL FORK  
TENEDOR DE PASTEL  
13,8 CM - 5 IN<sup>7/16</sup>



130266  
**FOURCHETTE À HUÎTRES**  
OYSTER FORK  
TENEDOR DE OSTRAS  
13 CM - 5 IN<sup>1/8</sup>

**PIECES DE SERVICE**  
SERVING PIECES  
SET SERVICIO  
**VERLAINE**  
P.138-139

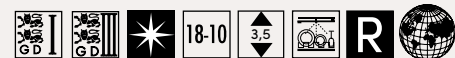

©Patrick ROUGEREAU





105278  
**FOURCHETTE DE TABLE**  
TABLE FORK  
TENEDOR DE MESA  
20,8 CM - 8 IN<sup>3/16</sup>



105274  
**COUTEAU DE TABLE**  
**MONOCOQUE MANCHE ORFÈVRE**  
**LAME SCIE**  
TABLE KNIFE HOLLOW HANDLE SERRATED  
CUCHILLO DE MESA ENMANGADO  
HOJA SIERRA  
24,6 CM - 9 IN<sup>17/16</sup>



105310  
**CUILLÈRE DE TABLE**  
TABLE / PASTA SPOON  
CUCHARA DE MESA  
20,8 CM - 8 IN<sup>3/16</sup>



105294  
**CUILLÈRE À DESSERT**  
DESSERT/SOUP SPOON, OVAL  
CUCHARA DE POSTRE  
18 CM - 7 IN<sup>11/16</sup>



105290  
**FOURCHETTE À DESSERT**  
DESSERT/SALAD FORK  
TENEDOR DE POSTRE  
17,8 CM - 7 IN



105305  
**COUTEAU À DESSERT**  
**MONOCOQUE MANCHE**  
**ORFÈVRE LAME UNIE**  
DESSERT KNIFE HOLLOW HANDLE  
CUCHILLO DE POSTRE ENMANGADO  
HOJA LISA  
20,5 CM - 8 IN<sup>17/16</sup>



105303  
**CUILLÈRE À CAFÉ**  
COFFEE/TEA SPOON  
CUCHARA DE CAFÉ  
14 CM - 5 IN<sup>1/2</sup>



105293  
**CUILLÈRE À MOKA**  
DEMI TASSE SPOON  
CUCHARA DE MOKA  
11 CM - 4 IN<sup>5/16</sup>







105831  
**FOURCHETTE DE TABLE**  
TABLE FORK  
TENEDOR DE MESA  
20,8 CM - 8 IN<sup>3/16</sup>



182460  
**COUTEAU DE TABLE MONOBLOC LOURD LAME SCIE**  
TABLE KNIFE HEAVY SOLID HANDLE SERRATED  
CUCHILLO DE MESA PESADO HOJA SIERRA  
24,6 CM - 9 IN<sup>1/16</sup>



105886  
**COUTEAU DE TABLE MONOCOQUE MANCHE ORFÈVRE LAME UNIE**  
TABLE KNIFE HOLLOW HANDLE CUCHILLO DE MESA ENMANGADO HOJA LISA  
24,6 CM - 9 IN<sup>1/16</sup>



105860  
**COUTEAU DE TABLE MONOCOQUE MANCHE ORFÈVRE LAME SCIE**  
TABLE KNIFE HOLLOW HANDLE SERRATED CUCHILLO DE MESA ENMANGADO HOJA SIERRA  
24,6 CM - 9 IN<sup>1/16</sup>



105801  
**COUTEAU À STEAK MONOCOQUE MANCHE ORFÈVRE LAME SCIE**  
STEAK KNIFE HOLLOW HANDLE SERRATED CUCHILLO DE STEAK ENMANGADO HOJA SIERRA  
23,9 CM - 9 IN<sup>7/16</sup>



105798  
**CUILLÈRE DE TABLE**  
TABLE/PASTA SPOON  
CUCHARA DE MESA  
20,8 CM - 8 IN<sup>3/16</sup>



112692  
**CUILLÈRE À SOUPE ANGLAISE**  
BOUILLON SPOON, ROUND  
CUCHARA DE CONSOMÉ  
17,2 CM - 6 IN<sup>3/4</sup>



105861  
**CUILLÈRE À DESSERT**  
DESSERT/SOUP SPOON, OVAL  
CUCHARA DE POSTRE  
18 CM - 7 IN<sup>1/16</sup>



105885  
**FOURCHETTE À DESSERT**  
DESSERT/SALAD FORK  
TENEDOR DE POSTRE  
17,8 CM - 7 IN



182463  
**COUTEAU À DESSERT MONOBLOC LOURD LAME UNIE**  
DESSERT KNIFE HEAVY SOLID HANDLE CUCHILLO DE POSTRE PESADO HOJA LISA  
21,1 CM - 8 IN<sup>5/16</sup>



105832  
**COUTEAU À DESSERT MONOCOQUE MANCHE ORFÈVRE LAME UNIE**  
DESSERT KNIFE HOLLOW HANDLE CUCHILLO DE POSTRE ENMANGADO HOJA LISA  
20,5 CM - 8 IN<sup>1/16</sup>



190420  
**COUTEAU À BEURRE MONOBLOC LOURD LAME UNIE**  
BUTTER KNIFE HEAVY SOLID HANDLE CUCHILLO DE MANTEQUILLA PESADO HOJA LISA  
19 CM - 7 IN<sup>1/2</sup>



003332  
**COUTEAU À BEURRE MONOCOQUE MANCHE ORFÈVRE LAME UNIE**  
BUTTER KNIFE HOLLOW HANDLE CUCHILLO DE MANTEQUILLA ENMANGADO HOJA LISA  
18,7 CM - 7 IN<sup>3/8</sup>



108918  
**FOURCHETTE À POISSON**  
FISH FORK  
TENEDOR DE PESCADO  
17,8 CM - 7 IN



108920  
**COUTEAU À POISSON**  
FISH KNIFE  
CUCHILLO DE PESCADO  
19,7 CM - 7 IN<sup>3/4</sup>



105910  
**CUILLÈRE À SAUCE GOURMET**  
GOURMET/SAUCE SPOON  
CUCHARA PARA SALSA  
17,9 CM - 7 IN<sup>1/16</sup>



105833  
**CUILLÈRE À CAFÉ**  
COFFEE/TEA SPOON  
CUCHARA DE CAFÉ  
14 CM - 5 IN<sup>1/2</sup>



105906  
**CUILLÈRE À MOKA**  
DEMI TASSE SPOON  
CUCHARA DE MOKA  
11 CM - 4 IN<sup>5/16</sup>



105800  
**CUILLÈRE À SODA**  
ICED TEA SPOON  
CUCHARA DE SODA/HELADO  
18,2 CM - 7 IN<sup>3/16</sup>



105795  
**FOURCHETTE À GÂTEAUX/ COCKTAIL**  
PASTRY/COCKTAIL FORK  
TENEDOR DE PASTEL  
13,8 CM - 5 IN<sup>7/16</sup>

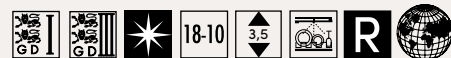

©Patrick ROUGEREAU

DEGERENNE





123440  
**FOURCHETTE À HÛITRES**  
OYSTER FORK  
TENEDOR DE OSTRAS  
12,9 CM - 5 IN<sup>17/16</sup>



132782  
**FOURCHETTE À ESCARGOTS**  
SNAIL FORK  
TENEDOR DE CARACOLES  
13,5 CM - 5 IN<sup>5/16</sup>



130994  
**CUILLÈRE À TOASTS**  
APPETIZER SPOON  
CUCHARA PARA APERITIVO  
11,8 CM - 7 IN<sup>27/16</sup>



003390  
**COUTEAU À FROMAGES  
MONOCOQUE MANCHE  
ORFÈVRE LAME UNIE**  
CHEESE KNIFE HOLLOW HANDLE  
CUCHILLO DE QUESO ENMANGADO  
19,3 CM - 7 IN<sup>5/8</sup>



002185  
**FOURCHETTE DE SERVICE**  
SERVING FORK  
TENEDOR DE SERVICIO/ENSALADA  
24,8 CM - 9 IN<sup>3/4</sup>



002186  
**CUILLÈRE DE SERVICE**  
SERVING SPOON  
CUCHARA DE SERVICIO/ENSALADA  
25 CM - 9 IN<sup>13/16</sup>



040646  
**SERVICE À SALADE**  
SALAD SERVING SET  
SET SERVICIO DE ENSALADA  
25,8 CM - 10 IN<sup>37/16</sup>



083340  
**PELLE À TARTE  
MONOBLOC**  
PASTRY SERVER SOLID HANDLE  
PALA PARA TARTA  
24,9 CM - 9 IN<sup>13/16</sup>



097717  
**LOUCHE**  
SOUP LADLE  
CAZO  
29,8 CM - 11 IN<sup>3/4</sup>



002179  
**LOUCHE À SAUCE**  
SAUCE LADLE  
CAZO PARA SALSAS  
15,7 CM - 6 IN<sup>3/16</sup>



002191  
**PINCE À SUCRE**  
SUGAR TONG  
PINZA PARA AZÚCAR  
11,5 CM - 4 IN<sup>1/2</sup>



©Patrick ROUGÈREAU







105021  
**FOURCHETTE DE TABLE**  
TABLE FORK  
TENEDOR DE MESA  
20,9 CM - 8 IN<sup>3/16</sup>



190415  
**COUTEAU DE TABLE  
MONOBLOC LOURD**  
**LAME SCIE**  
TABLE KNIFE SOLID HANDLE SERRATED  
CUCHILLO DE MESA PESADO  
HOJA SIERRA  
24,8 CM - 9 IN<sup>3/4</sup>



105006  
**COUTEAU DE TABLE  
MONOCOQUE MANCHE**  
**ORFÈVRE LAME SCIE**  
TABLE KNIFE HOLLOW HANDLE SERRATED  
CUCHILLO DE MESA ENMANGADO  
HOJA SIERRA  
24,7 CM - 9 IN<sup>3/4</sup>



122746  
**COUTEAU À STEAK  
MONOCOQUE MANCHE**  
**ORFÈVRE LAME SCIE**  
STEAK KNIFE HOLLOW HANDLE SERRATED  
CUCHILLO DE STEAK ENMANGADO  
HOJA SIERRA  
23,8 CM - 9 IN<sup>3/8</sup>



104988  
**CUILLÈRE DE TABLE**  
TABLE/ PASTA SPOON  
CUCHARA DE MESA  
21,1 CM - 8 IN<sup>5/16</sup>



104975  
**CUILLÈRE À SOUPE ANGLAISE**  
BOUILLON SPOON, ROUND  
CUCHARA DE CONSOMÉ  
17,4 CM - 6 IN<sup>7/8</sup>



104985  
**CUILLÈRE À DESSERT**  
DESSERT/SOUP SPOON, OVAL  
CUCHARA DE POSTRE  
18 CM - 7 IN<sup>1/16</sup>



105013  
**FOURCHETTE À DESSERT**  
DESSERT/SALAD FORK  
TENEDOR DE POSTRE  
17,9 CM - 7 IN<sup>1/8</sup>



190416  
**COUTEAU À DESSERT  
MONOBLOC LOURD**  
**LAME UNIE**  
DESSERT KNIFE SOLID HANDLE  
CUCHILLO DE POSTRE PESADO  
HOJA LISA  
21,3 CM - 8 IN<sup>3/8</sup>



104989  
**COUTEAU À DESSERT  
MONOCOQUE MANCHE**  
**ORFÈVRE LAME UNIE**  
DESSERT KNIFE HOLLOW HANDLE  
CUCHILLO DE POSTRE  
ENMANGADO HOJA LISA  
20,6 CM - 8 IN<sup>1/8</sup>



190414  
**COUTEAU À BEURRE  
MONOBLOC LOURD**  
**LAME UNIE**  
BUTTER KNIFE SOLID HANDLE  
CUCHILLO DE MANTEQUILLA  
PESADO HOJA LISA  
19,7 CM - 7 IN<sup>3/4</sup>



016394  
**COUTEAU À BEURRE  
MONOCOQUE MANCHE**  
**ORFÈVRE LAME UNIE**  
BUTTER KNIFE HOLLOW HANDLE  
CUCHILLO DE MANTEQUILLA  
ENMANGADO HOJA LISA  
18,9 CM - 7 IN<sup>7/16</sup>



104994  
**FOURCHETTE À POISSON**  
FISH FORK  
TENEDOR DE PESCADO  
17,9 CM - 7 IN<sup>1/16</sup>



104995  
**COUTEAU À POISSON**  
FISH KNIFE  
CUCHILLO DE PESCADO  
20 CM - 7 IN<sup>7/8</sup>



104977  
**CUILLÈRE À SAUCE  
GOURMET**  
GOURMET/SAUCE SPOON  
CUCHARA PARA SALSA  
18 CM - 7 IN<sup>1/16</sup>



104986  
**CUILLÈRE À CAFÉ**  
COFFEE/TEA SPOON  
CUCHARA DE CAFÉ  
14,1 CM - 5 IN<sup>37/16</sup>



104993  
**CUILLÈRE À MOKA**  
DEMI TASSE SPOON  
CUCHARA DE MOKA  
11,2 CM - 4 IN<sup>1/16</sup>



105012  
**FOURCHETTE À GÂTEAUX/  
COCKTAIL**  
PASTRY/COCKTAIL FORK  
TENEDOR DE PASTEL  
13,9 CM - 5 IN<sup>1/2</sup>







104485  
**FOURCHETTE DE TABLE**  
TABLE FORK  
TENEDOR DE MESA  
20,8 CM - 8 IN<sup>3/16</sup>



182466  
**COUTEAU DE TABLE MONOBLOC LOURD LAME SCIE**  
TABLE KNIFE HEAVY SOLID HANDLE SERRATED  
CUCHILLO DE MESA PESADO SIERRA  
24,6 CM - 9 IN<sup>1/16</sup>



161390  
**COUTEAU DE TABLE MONOCOQUE MANCHE ORFÈVRE LAME UNIE**  
TABLE KNIFE HOLLOW HANDLE  
CUCHILLO DE MESA ENMANGADO HOJA LISA  
24,6 CM - 9 IN<sup>1/16</sup>



161391  
**COUTEAU DE TABLE MONOCOQUE MANCHE ORFÈVRE LAME SCIE**  
TABLE KNIFE HOLLOW HANDLE SERRATED  
CUCHILLO DE MESA ENMANGADO HOJA SIERRA  
24,6 CM - 9 IN<sup>1/16</sup>



122759  
**COUTEAU À STEAK MONOCOQUE MANCHE ORFÈVRE LAME SCIE**  
STEAK KNIFE HOLLOW HANDLE SERRATED  
CUCHILLO DE STEAK ENMANGADO HOJA SIERRA  
23,9 CM - 9 IN<sup>7/16</sup>



104526  
**CUILLÈRE DE TABLE**  
TABLE/PASTA SPOON  
CUCHARA DE MESA  
20,8 CM - 8 IN<sup>3/16</sup>



112695  
**CUILLÈRE À SOUPE ANGLAISE**  
BOUILLON SPOON, ROUND  
CUCHARA DE CONSOMÉ  
17,2 CM - 6 IN<sup>3/4</sup>



104484  
**CUILLÈRE À DESSERT**  
DESSERT/SOUP SPOON, OVAL  
CUCHARA DE POSTRE  
18 CM - 7 IN<sup>1/16</sup>



104543  
**FOURCHETTE À DESSERT**  
DESSERT/SALAD FORK  
TENEDOR DE POSTRE  
17,8 CM - 7 IN



182467  
**COUTEAU À DESSERT MONOBLOC LOURD LAME UNIE**  
DESSERT KNIFE HEAVY SOLID HANDLE  
CUCHILLO DE POSTRE PESADO HOJA LISA  
20,5 CM - 8 IN<sup>1/16</sup>



161394  
**COUTEAU À DESSERT MONOCOQUE MANCHE ORFÈVRE LAME UNIE**  
DESSERT KNIFE HOLLOW HANDLE  
CUCHILLO DE POSTRE ENMANGADO HOJA LISA  
20,5 CM - 8 IN<sup>1/16</sup>



190419  
**COUTEAU À BEURRE MONOBLOC LOURD LAME UNIE**  
BUTTER KNIFE HEAVY SOLID HANDLE  
CUCHILLO DE MANTEQUILLA PESADO HOJA LISA  
18,7 CM - 7 IN<sup>3/8</sup>



122760  
**COUTEAU À BEURRE MONOCOQUE MANCHE ORFÈVRE LAME UNIE**  
BUTTER KNIFE HOLLOW HANDLE  
CUCHILLO DE MANTEQUILLA ENMANGADO HOJA LISA  
18,7 CM - 7 IN<sup>3/8</sup>



108922  
**FOURCHETTE À POISSON**  
FISH FORK  
TENEDOR DE PESCADO  
17,8 CM - 7 IN



108924  
**COUTEAU À POISSON**  
FISH KNIFE  
CUCHILLO DE PESCADO  
19,7 CM - 7 IN<sup>3/4</sup>



145451  
**CUILLÈRE À SAUCE GOURMET**  
GOURMET/SAUCE SPOON  
CUCHARA PARA SALSA  
17,9 CM - 7 IN<sup>1/16</sup>



104561  
**CUILLÈRE À CAFÉ**  
COFFEE/TEA SPOON  
CUCHARA DE CAFÉ  
14 CM - 5 IN<sup>1/2</sup>



161398  
**CUILLÈRE À MOKA**  
DEMI TASSE SPOON  
CUCHARA DE MOKA  
11 CM - 4 IN<sup>5/16</sup>



124259  
**CUILLÈRE À SODA**  
ICED TEA SPOON  
CUCHARA DE SODA/HELADO  
18,2 CM - 7 IN<sup>3/16</sup>



104480  
**FOURCHETTE À GÂTEAUX/ COCKTAIL**  
PASTRY/COCKTAIL FORK  
TENEDOR DE PASTEL  
13,8 CM - 5 IN<sup>7/16</sup>



© Patrick ROUGEREAU

L'ABUS D'ALCOOL EST DANGEREUX POUR LA SANTÉ  
DEGRENE PROMOTES RESPONSIBLE DRINKING AND DISCOURAGES ALCOHOL MISUSE  
EL ABUSO DE ALCOHOL ES PELIGROSO PARA LA SALUD

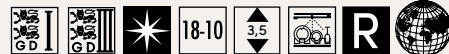





123434  
**FOURCHETTE À HÙITRES**  
OYSTER FORK  
TENEDOR DE OSTRAS  
12,9 CM - 5 IN<sup>17/16</sup>



189208  
**COUTEAU À FROMAGE  
MONOCOQUE MANCHE  
ORFÈVRE LAME UNIE**  
CHEESE KNIFE HOLLOW HANDLE  
CUCHILLO QUESO ENMANGADO  
19,3 CM - 7 IN<sup>5/8</sup>



195757  
**FOURCHETTE DE SERVICE**  
SERVING FORK  
TENEDOR DE SERVICIO/ENSALADA  
24,8 CM - 9 IN<sup>3/4</sup>



195755  
**CUILLÈRE DE SERVICE**  
SERVING SPOON  
CUCHARA DE SERVICIO/ENSALADA  
25 CM - 9 IN<sup>37/16</sup>



195757  
**FOURCHETTE À DÉCOUPER**  
CARVING FORK  
TENEDOR TRINCHANTE  
24,8 CM - 9 IN<sup>3/4</sup>



189511  
**COUTEAU À DÉCOUPER  
MONOCOQUE/MANCHE  
ORFÈVRE LAME UNIE**  
CARVING KNIFE HOLLOW HANDLE  
CUCHILLO TRINCHANTE ENMANGADO  
HOJA LISA  
28,7 CM - 11 IN<sup>57/16</sup>



195750  
**SERVICE À SALADE**  
SALAD SERVING SET  
SET SERVICIO/ENSALADA  
25,7 CM - 10 IN<sup>19</sup>



195753  
**PELLE À TARTE  
MONOBLOC**  
PASTRY SERVER SOLID HANDLE  
PALA PARA TARTA  
24,9 CM - 9 IN<sup>137/16</sup>



195762  
**LOUCHE**  
SOUP LADLE  
CAZO  
29,8 CM - 11 IN<sup>3/4</sup>



195759  
**LOUCHE À SAUCE**  
SAUCE LADLE  
CAZO PARA SALSA  
15,7 CM - 6 IN<sup>37/16</sup>



©Patrick ROUGEREAU





235927  
**FOURCHETTE DE TABLE**  
TABLE FORK  
TENEDOR DE MESA  
19,9 CM - 7 IN<sup>37/16</sup>



235930  
**COUTEAU DE TABLE MONOBLOC LAME SCIE**  
TABLE KNIFE SOLID HANDLE SERRATED  
CUCHILLO DE MESA HOJA SIERRA  
23,2 CM - 9 IN<sup>17/8</sup>



235928  
**CUILLÈRE DE TABLE**  
TABLE SPOON  
CUCHARA DE MESA  
19,9 CM - 7 IN<sup>37/16</sup>



235938  
**CUILLÈRE À SOUPE ANGLAISE**  
BOUILLON SPOON, ROUND  
CUCHARA DE CONSOMÉ  
18,4 CM - 7 IN<sup>11/4</sup>



235934  
**CUILLÈRE À DESSERT**  
DESSERT/SOUP SPOON, OVAL  
CUCHARA DE POSTRE  
18,4 CM - 7 IN<sup>11/4</sup>



235933  
**FOURCHETTE À DESSERT**  
DESSERT/SALAD FORK  
TENEDOR DE POSTRE  
18,4 CM - 7 IN<sup>11/4</sup>



235935  
**COUTEAU À DESSERT MONOBLOC LAME SCIE**  
DESSERT KNIFE SOLID HANDLE  
SERRATED  
CUCHILLO DE POSTRE HOJA SIERRA  
20,9 CM - 8 IN<sup>37/16</sup>



235939  
**COUTEAU À BEURRE MONOBLOC LAME UNIE**  
BUTTER KNIFE SOLID HANDLE  
CUCHILLO DE MANTEQUILLA HOJA LISA  
16,5 CM - 6 IN<sup>17/2</sup>



235929  
**CUILLÈRE À CAFÉ**  
COFFEE/TEA SPOON  
CUCHARA DE CAFÉ  
13,9 CM - 5 IN<sup>17/2</sup>



235932  
**CUILLÈRE À MOKA**  
DEMI TASSE SPOON  
CUCHARA DE MOKA  
10,9 CM - 4 IN<sup>57/16</sup>



235937  
**FOURCHETTE À COCKTAIL**  
COCKTAIL FORK  
TENEDOR DE COCKTAIL  
14,1 CM - 5 IN<sup>97/16</sup>



231218  
**FOURCHETTE DE SERVICE**  
SERVING FORK  
TENEDOR DE SERVICIO/ENSALADA  
26,6 CM - 10 IN<sup>11/2</sup>



231219  
**CUILLÈRE DE SERVICE**  
SERVING SPOON  
CUCHARA DE SERVICIO/ENSALADA  
26,6 CM - 10 IN<sup>11/2</sup>



231221  
**PELLE À TARTE MONOBLOC**  
PASTRY SERVER SOLID HANDLE  
PALA PARA TARTA  
25,2 CM - 9 IN<sup>15/16</sup>



231220  
**LOUCHE**  
SOUP LADLE  
CAZO  
29 CM - 11 IN<sup>27/8</sup>



LES COUVERTS  
FLATWARE - CUBIERTOS



©Patrick ROUGEREAU



# MIKADO MIROIR

LES COUVERTS  
FLATWARE - CUBIERTOS



141089  
**FOURCHETTE DE TABLE**  
TABLE FORK  
TENEDOR DE MESA  
20,3 CM - 8 IN

113017  
**COUTEAU DE TABLE MONOBLOC LOURD LAME SCIE**  
TABLE KNIFE SOLID HANDLE SERRATED  
CUCHILLO DE MESA PESADO  
HOJA SIERRA  
24,4 CM - 9 IN<sup>5/8</sup>

160427  
**COUTEAU À STEAK MONOBLOC LAME SCIE**  
STEAK KNIFE SOLID HANDLE SERRATED  
CUCHILLO DE STEAK  
HOJA SIERRA  
23,2 CM - 9 IN<sup>5/8</sup>

141086  
**CUILLÈRE DE TABLE**  
TABLE/ PASTA SPOON  
CUCHARA DE MESA  
20,4 CM - 8 IN<sup>7/16</sup>

112695  
**CUILLÈRE À SOUPE ANGLAISE**  
BOUILLON SPOON, ROUND  
CUCHARA DE CONSOMÉ  
17,2 CM - 6 IN<sup>3/4</sup>

108236  
**CUILLÈRE À DESSERT**  
DESSERT/SOUP SPOON, OVAL  
CUCHARA DE POSTRE  
17,9 CM - 7 IN<sup>17/16</sup>

108238  
**FOURCHETTE À DESSERT**  
DESSERT/SALAD FORK  
TENEDOR DE POSTRE  
17,8 CM - 7 IN

113019  
**COUTEAU À DESSERT MONOBLOC LOURD LAME UNIE**  
DESSERT KNIFE SOLID HANDLE  
CUCHILLO DE POSTRE PESADO  
HOJA LISA  
21 CM - 8 IN<sup>3/4</sup>

189971  
**COUTEAU À BEURRE MONOBLOC LAME UNIE**  
BUTTER KNIFE SOLID HANDLE  
CUCHILLO DE MANTEQUILLA  
HOJA LISA  
18,9 CM - 7 IN<sup>7/16</sup>

108922  
**FOURCHETTE À POISSON**  
FISH FORK  
TENEDOR DE PESCADO  
17,8 CM - 7 IN

108924  
**COUTEAU À POISSON**  
FISH KNIFE  
CUCHILLO DE PESCADO  
19,7 CM - 7 IN<sup>3/4</sup>



103550  
**CUILLÈRE À CAFÉ**  
COFFEE/TEA SPOON  
CUCHARA DE CAFÉ  
13,5 CM - 5 IN<sup>5/16</sup>

109465  
**CUILLÈRE À MOKA**  
DEMI TASSE SPOON  
CUCHARA DE MOKA  
11 CM - 4 IN<sup>5/16</sup>

124259  
**CUILLÈRE À SODA**  
ICED TEA SPOON  
CUCHARA DE SODA/HELADO  
18,2 CM - 7 IN<sup>3/16</sup>

109466  
**FOURCHETTE À GÂTEAUX/ COCKTAIL**  
PASTRY/COCKTAIL FORK  
TENEDOR DE PASTEL  
15 CM - 5 IN<sup>7/8</sup>

123434  
**FOURCHETTE À HUÎTRES**  
OYSTER FORK  
TENEDOR DE OSTRAS  
12,9 CM - 5 IN<sup>1/16</sup>

195757  
**FOURCHETTE DE SERVICE**  
SERVING FORK  
TENEDOR DE SERVICIO/ENSALADA  
24,8 CM - 9 IN<sup>3/4</sup>

195755  
**CUILLÈRE DE SERVICE**  
SERVING SPOON  
CUCHARA DE SERVICIO/ENSALADA  
25 CM - 9 IN<sup>13/16</sup>

195750  
**SERVICE À SALADE**  
SALAD SERVING SET  
SET SERVICIO/ENSALADA  
25,7 CM - 10 IN<sup>1/8</sup>

195753  
**PELLE À TARTE MONOBLOC**  
PASTRY SERVER SOLID HANDLE  
PALA PARA TARTA  
24,9 CM - 9 IN<sup>13/16</sup>

195762  
**LOUCHE**  
SOUP LADLE  
CAZO  
29,8 CM - 11 IN<sup>3/4</sup>

195759  
**LOUCHE À SAUCE**  
SAUCE LADLE  
CAZO PARA SALSA  
15,7 CM - 6 IN<sup>3/16</sup>



©Patrick ROUGEREAU



# MIKADO VINTAGE

LES COUVERTS  
FLATWARE - CUBIERTOS



DEGRÈNE



230285  
**FOURCHETTE DE TABLE**  
TABLE FORK  
TENEDOR DE MESA  
20,3 CM - 8 IN

230287  
**COUTEAU DE TABLE  
MONOBLOC LOURD**  
**LAME SCIE**  
TABLE KNIFE SOLID HANDLE SERRATED  
CUCHILLO DE MESA PESADO  
HOJA SIERRA  
24,4 CM - 9 IN<sup>5/8</sup>

230293  
**COUTEAU À STEAK  
MONOBLOC LAME SCIE**  
STEAK KNIFE SOLID HANDLE SERRATED  
CUCHILLO DE STEAK  
HOJA SIERRA  
23,2 CM - 9 IN<sup>1/8</sup>

230286  
**CUILLÈRE DE TABLE**  
TABLE / PASTA SPOON  
CUCHARA DE MESA  
20,4 CM - 8 IN<sup>1/16</sup>

230291  
**CUILLÈRE À DESSERT**  
DESSERT/SOUP SPOON, OVAL  
CUCHARA DE POSTRE  
17,9 CM - 7 IN<sup>1/16</sup>

230290  
**FOURCHETTE À DESSERT**  
DESSERT/SALAD FORK  
TENEDOR DE POSTRE  
17,8 CM - 7 IN

230292  
**COUTEAU À DESSERT  
MONOBLOC LOURD**  
**LAME UNIE**  
DESSERT KNIFE SOLID HANDLE  
CUCHILLO DE POSTRE PESADO  
HOJA LISA  
21 CM - 8 IN<sup>1/4</sup>

232308  
**COUTEAU À BEURRE  
MONOBLOC**  
**LAME UNIE**  
BUTTER KNIFE SOLID HANDLE  
CUCHILLO DE MANTEQUILLA  
HOJA LISA  
18,9 CM - 7 IN<sup>7/16</sup>

230288  
**CUILLÈRE À CAFÉ**  
COFFEE/TEA SPOON  
CUCHARA DE CAFÉ  
13,5 CM - 5 IN<sup>5/16</sup>

230289  
**CUILLÈRE À MOKA**  
DEMI TASSE SPOON  
CUCHARA DE MOKA  
11 CM - 4 IN<sup>5/16</sup>

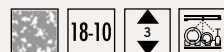

©Patrick ROUGEREAU





141094  
**FOURCHETTE DE TABLE**  
TABLE FORK  
TENEDOR DE MESA  
20,3 CM - 8 IN



103857  
**COUTEAU DE TABLE  
MONOBLOC LAME SCIE**  
TABLE KNIFE SOLID HANDLE SERRATED  
CUCHILLO DE MESA  
HOJA SIERRA  
23,7CM - 9 IN<sup>5/16</sup>



160433  
**COUTEAU À STEAK  
MONOBLOC LAME SCIE**  
STEAK KNIFE SOLID HANDLE SERRATED  
CUCHILLO DE STEAK  
HOJA SIERRA  
23,6 CM - 9 IN<sup>5/16</sup>



141092  
**CUILLÈRE DE TABLE**  
TABLE/ PASTA SPOON  
CUCHARA DE MESA  
20,4 CM - 8 IN<sup>1/8</sup>



112692  
**CUILLÈRE À SOUPE ANGLAISE**  
BOUILLON SPOON, ROUND  
CUCHARA DE CONSOMÉ  
17,2 CM - 6 IN<sup>3/4</sup>



108232  
**CUILLÈRE À DESSERT**  
DESSERT/SOUP SPOON, OVAL  
CUCHARA DE POSTRE  
17,9 CM - 7 IN<sup>1/16</sup>



108234  
**FOURCHETTE À DESSERT**  
DESSERT/SALAD FORK  
TENEDOR DE POSTRE  
17,8 CM - 7 IN



210628  
**COUTEAU À DESSERT  
MONOBLOC LAME SCIE**  
DESSERT KNIFE SOLID HANDLE  
CUCHILLO DE POSTRE PESADO  
HOJA LISA  
20,6 CM - 8 IN<sup>1/8</sup>



108918  
**FOURCHETTE À POISSON**  
FISH FORK  
TENEDOR DE PESCADO  
17,8 CM - 7 IN



108920  
**COUTEAU À POISSON**  
FISH KNIFE  
CUCHILLO DE PESCADO  
19,7 CM - 7 IN<sup>3/4</sup>



103564  
**CUILLÈRE À CAFÉ**  
COFFEE/TEA SPOON  
CUCHARA DE CAFÉ  
13,5 CM - 5 IN<sup>5/16</sup>



109471  
**CUILLÈRE À MOKA**  
DEMI TASSE SPOON  
CUCHARA DE MOKA  
11 CM - 4 IN<sup>5/16</sup>



105800  
**CUILLÈRE À SODA**  
ICED TEA SPOON  
CUCHARA DE SODA/HELADO  
18,2 CM - 7 IN<sup>3/16</sup>



109472  
**FOURCHETTE À GÂTEAUX/  
COCKTAIL**  
PASTRY/COCKTAIL FORK  
TENEDOR DE PASTEL  
15 CM - 5 IN<sup>7/8</sup>



123440  
**FOURCHETTE À HÙÎTRES**  
OYSTER FORK  
TENEDOR DE OSTRAS  
12,9 CM - 5 IN<sup>1/16</sup>



132782  
**FOURCHETTE À ESCARGOTS**  
SNAIL FORK  
TENEDOR DE CARACOLES  
13,5 CM - 5 IN<sup>5/16</sup>



002185  
**FOURCHETTE DE SERVICE**  
SERVING FORK  
TENEDOR DE SERVICIO/ENSALADA  
24,8 CM - 9 IN<sup>3/4</sup>



002186  
**CUILLÈRE DE SERVICE**  
SERVING SPOON  
CUCHARA DE SERVICIO/ENSALADA  
25 CM - 9 IN<sup>13/16</sup>



040646  
**SERVICE À SALADE**  
SALAD SERVING SET  
SET SERVICIO DE ENSALADA  
25,8 CM - 10 IN<sup>3/16</sup>



083340  
**PELLE À TARTE  
MONOBLOC**  
PASTRY SERVER SOLID HANDLE  
PALA PARA TARTA  
24,9 CM - 9 IN<sup>13/16</sup>



097717  
**LOUCHE**  
SOUP LADLE  
CAZO  
29,8 CM - 11 IN<sup>3/4</sup>



002179  
**LOUCHE À SAUCE**  
SAUCE LADLE  
CAZO PARA SALSAS  
15,7 CM - 6 IN<sup>3/16</sup>





# VIEUX PARIS SATINÉ

LES COUVERTS  
FLATWARE - CUBIERTOS



105804  
**FOURCHETTE DE TABLE**  
TABLE FORK  
TENEDOR DE MESA  
21 CM - 8 IN<sup>1/4</sup>



105837  
**FOURCHETTE À POISSON**  
FISH FORK  
TENEDOR DE PESCADO  
18 CM - 7 IN<sup>1/16</sup>



105892  
**COUTEAU DE TABLE  
MONOBLOC LAME SCIE**  
TABLE KNIFE SOLID HANDLE SERRATED  
CUCHILLO DE MESA  
HOJA SIERRA  
25 CM - 9 IN<sup>13/16</sup>



105912  
**COUTEAU À POISSON**  
FISH KNIFE  
CUCHILLO DE PESCADO  
20 CM - 7 IN<sup>7/8</sup>



105864  
**COUTEAU DE TABLE  
MONOCOQUE MANCHE  
ORFÈVRE LAME UNIE**  
TABLE KNIFE HOLLOW HANDLE  
CUCHILLO DE MESA ENMANGADO  
HOJA LISA  
24,7 CM - 9 IN<sup>3/4</sup>



105838  
**CUILLÈRE À CAFÉ**  
COFFEE/TEA SPOON  
CUCHARA DE CAFÉ  
14,1 CM - 5 IN<sup>9/16</sup>



105913  
**COUTEAU DE TABLE  
MONOCOQUE MANCHE  
ORFÈVRE LAME SCIE**  
TABLE KNIFE HOLLOW HANDLE SERRATED  
CUCHILLO DE MESA ENMANGADO  
HOJA SIERRA  
24,7 CM - 9 IN<sup>3/4</sup>



105891  
**CUILLÈRE À MOKA**  
DEMI TASSE SPOON  
CUCHARA DE MOKA  
11 CM - 4 IN<sup>5/16</sup>



160424  
**COUTEAU À STEAK  
MONOBLOC LAME SCIE**  
STEAK KNIFE SOLID HANDLE SERRATED  
CUCHILLO DE STEAK  
HOJA SIERRA  
23,2 CM - 9 IN<sup>1/8</sup>



105805  
**FOURCHETTE À GÂTEAUX/  
COCKTAIL**  
PASTRY/COCKTAIL FORK  
TENEDOR DE PASTEL  
13,9 CM - 5 IN<sup>1/2</sup>



105911  
**CUILLÈRE DE TABLE**  
TABLE/ PASTA SPOON  
CUCHARA DE MESA  
21 CM - 8 IN<sup>1/4</sup>



105803  
**FOURCHETTE À HÙITRES**  
OYSTER FORK  
TENEDOR DE OSTRAS  
13,2 CM - 5 IN<sup>3/16</sup>



105863  
**CUILLÈRE À DESSERT**  
DESSERT/SOUP SPOON, OVAL  
CUCHARA DE POSTRE  
18 CM - 7 IN<sup>1/16</sup>



000490  
**FOURCHETTE DE SERVICE**  
SERVING FORK  
TENEDOR DE SERVICIO/ENSALADA  
24,6 CM - 9 IN<sup>11/16</sup>



105890  
**FOURCHETTE À DESSERT**  
DESSERT/SALAD FORK  
TENEDOR DE POSTRE  
18 CM - 7 IN



000491  
**CUILLÈRE DE SERVICE**  
SERVING SPOON  
CUCHARA DE SERVICIO/ENSALADA  
24,9 CM - 9 IN<sup>13/16</sup>



210626  
**COUTEAU À DESSERT  
MONOBLOC LAME SCIE**  
DESSERT KNIFE SOLID HANDLE  
CUCHILLO DE POSTRE PESADO  
HOJA LISA  
20,7 CM - 8 IN<sup>1/8</sup>



105802  
**COUTEAU À DESSERT  
MONOCOQUE MANCHE  
ORFÈVRE LAME UNIE**  
DESSERT KNIFE HOLLOW HANDLE  
CUCHILLO DE POSTRE ENMANGADO  
HOJA LISA  
20,5 CM - 8 IN<sup>1/16</sup>

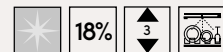





---

## PLATERIE

---

A travers des objets en acier dédiés à la table, au service et à la dégustation, DEGRENNE exprime la richesse de son métier d'orfèvre. Des pièces de forme aux **lignes raffinées** jusqu'aux accessoires présentés sur la table des convives, **la collection platerie DEGRENNE s'accorde parfaitement avec l'ensemble des gammes** pour offrir un service élégant et moderne.

---

### HOLLOWARE

---

DEGRENNE expresses its highly-varied metal-working expertise through steel products designed for the table, service and tasting and appreciating. From shaped pieces with **sophisticated lines** to accessories showcased on the guests' table, **DEGRENNE's holloware collection fits perfectly with all the other ranges**, making for an elegant and contemporary service.

---

### ORFEBRERÍA

---

A través de los objetos de acero dedicados a la mesa, al servicio y a la degustación, DEGRENNE expresa la riqueza de su oficio de orfebre. Desde piezas de forma con **líneas refinadas** hasta accesorios presentados en la mesa de los invitados, **la colección de platería DEGRENNE combina perfectamente con el conjunto de las gamas** para ofrecer un servicio elegante y moderno.

**NEWPORT**  
182614 - CLOCHE ASSIETTE  
DOME COVER STAINLESS STEEL - CAMPANA

P.168





PLATEAUX – SERVING TRAYS – BANDEJAS

PLATEAUX EMPILABLES  
STACKABLE SERVING TRAYS  
APILABLES BANDEJAS



185018 + 186458  
**PLATEAU RECTANGULAIRE  
AVEC ANSES**  
RECTANGULAR SERVING TRAYS  
WITH HANDLES  
BANDEJA RECTANGULAR CON ASAS  
77 X 55 CM – 30 IN<sup>5/16</sup> X 21 IN<sup>5/8</sup>

185023 + 186459  
**PLATEAU RECTANGULAIRE  
AVEC ANSES GASTRONORM 2/1**  
RECTANGULAR SERVING TRAYS  
WITH HANDLES  
BANDEJA RECTANGULAR CON ASAS  
65 X 53 CM – 25 IN<sup>9/16</sup> X 20 IN<sup>7/8</sup>

185022 + 186460  
**PLATEAU RECTANGULAIRE  
AVEC ANSES**  
RECTANGULAR SERVING TRAYS  
WITH HANDLES  
BANDEJA RECTANGULAR CON ASAS  
60 X 40 CM – 23 IN<sup>5/8</sup> X 15 IN<sup>3/4</sup>



185021 + 186461  
**PLATEAU RECTANGULAIRE  
SANS ANSES GASTRONORM 1/1**  
RECTANGULAR SERVING TRAYS  
WITHOUT HANDLES  
BANDEJA RECTANGULAR SIN ASAS  
53 X 32,5 CM – 20 IN<sup>7/8</sup> X 12 IN<sup>13/16</sup>



185020 + 186462  
**PLATEAU RECTANGULAIRE  
SANS ANSES**  
RECTANGULAR SERVING TRAYS  
WITHOUT HANDLES  
BANDEJA RECTANGULAR SIN ASAS  
40 X 27 CM – 15 IN<sup>3/4</sup> X 10 IN<sup>5/8</sup>



185019 + 186463  
**PLATEAU RECTANGULAIRE  
SANS ANSES GASTRONORM 1/2**  
RECTANGULAR SERVING TRAYS  
WITHOUT HANDLES  
BANDEJA RECTANGULAR SIN ASAS  
32,5 X 26,5 CM – 12 IN<sup>13/16</sup> X 10 IN<sup>7/16</sup>



227767 + 227768  
**PLATEAU RECTANGULAIRE  
SANS ANSES**  
RECTANGULAR SERVING TRAYS  
WITHOUT HANDLES  
BANDEJA RECTANGULAR SIN ASAS  
22 X 14 CM – 8 IN<sup>11/16</sup> X 5 IN<sup>1/2</sup>



185024 + 186457  
**PLATEAU ROND**  
ROUND TRAY  
BANDEJA REDONDA  
42 CM – 16 IN<sup>9/16</sup>

NORMANDY

**NEW**  
232972 +  
**PLATEAU RECTANGULAIRE**  
RECTANGULAR SERVING TRAY  
BANDEJA RECTANGULAR  
26 X 18 CM – 10 IN<sup>1/4</sup> X 7 IN<sup>17/16</sup>





# NEWPORT CUBIQUE

PLATEAUX - SERVING TRAYS - BANDEJAS

PLATEAUX EMPILABLES  
STACKABLE SERVING TRAYS  
APILABLES BANDEJAS

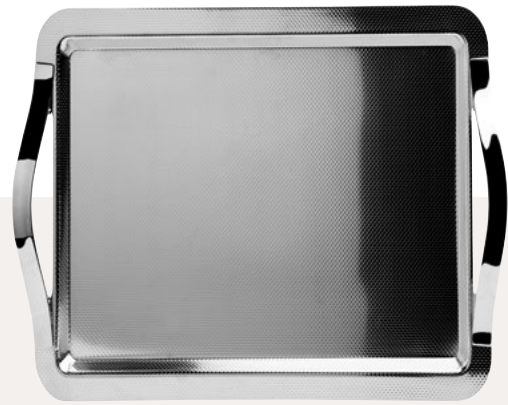

211886 + 213857  
**PLATEAU RECTANGULAIRE  
AVEC ANSES GATRONORM 2/1**  
RECTANGULAR SERVING TRAYS  
WITH HANDLES  
BANDEJA RECTANGULAR CON ASAS  
65 X 53 CM - 25 IN<sup>9/16</sup> X 20 IN<sup>7/8</sup>

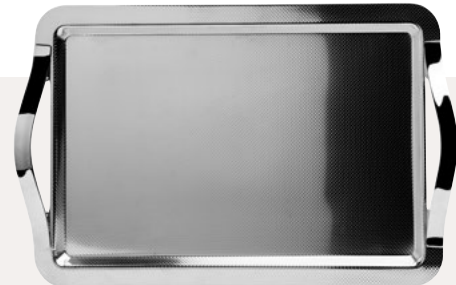

211887 + 213858  
**PLATEAU RECTANGULAIRE  
AVEC ANSES**  
RECTANGULAR SERVING TRAYS  
WITH HANDLES  
BANDEJA RECTANGULAR CON ASAS  
60 X 40 CM - 23 IN<sup>5/8</sup> X 15 IN<sup>3/4</sup>

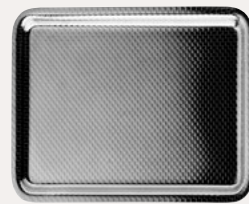

211888 + 213859  
**PLATEAU RECTANGULAIRE  
SANS ANSES GASTRONORM 1/2**  
RECTANGULAR SERVING TRAYS  
WITHOUT HANDLES  
BANDEJA RECTANGULAR SIN ASAS  
32,5 X 26,5 CM - 12 IN<sup>13/16</sup> X 10 IN<sup>7/16</sup>

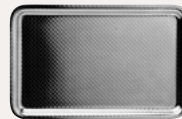

211889 + 213860  
**PLATEAU RECTANGULAIRE  
SANS ANSES**  
RECTANGULAR SERVING TRAYS  
WITHOUT HANDLES  
BANDEJA RECTANGULAR SIN ASAS  
22 X 14 CM - 8 IN<sup>7/16</sup> X 5 IN<sup>1/2</sup>



230872 + 230874  
**DESSOUS DE BOUTEILLE**  
BOTTLE COASTER  
POSABOTELLA  
13,5 CM - 5 IN<sup>5/16</sup>





NEWPORT

SERVICE À TABLE - TABLE SERVICE - SERVICIO DE MESA



183019 + 186451  
**PLAT OVALE**  
OVAL DISH  
FUENTE OVOLADO  
46 X 31 CM - 18 IN<sup>1/8</sup> X 12 IN<sup>3/16</sup>



183018 + 186450  
**PLAT OVALE**  
OVAL DISH  
FUENTE OVOLADO  
41 X 28 CM - 16 IN<sup>1/8</sup> X 11 IN



183017 + 186449  
**PLAT OVALE**  
OVAL DISH  
FUENTE OVOLADO  
38 X 25 CM - 14 IN<sup>15/16</sup> X 9 IN<sup>13/16</sup>



183021 + 186453  
**PLAT À POISSON**  
FISH DISH  
FUENTE PARA PESCADO  
60 X 27 CM - 23 IN<sup>5/8</sup> X 10 IN<sup>5/8</sup>



220120 + 220121  
**PLAT ROND CREUX**  
ROUND DEEP DISH  
BANDEJA REDONDA  
33,5 CM - 13 IN<sup>3/16</sup>



186198 + 186456  
**SAUCIÈRE**  
SAUCE BOAT  
SALSERA  
19 X 7,6 CM - 7 IN<sup>1/2</sup> X 3 IN  
20 CL - 6 OZ<sup>3/4</sup>



185307 + 186455  
**BEURRIER**  
BUTTER DISH  
MANTEQUILLERA INDIV.  
Ø 7,6 X 7 CM  
Ø 3 IN X 2 IN<sup>3/4</sup>



190255  
**SOCLE BEURRIER PORCELAINE**  
BUTTER DISH BASE PORCELAIN  
MANTEQUILLERA SIN TAPA  
Ø 5 X 3,2 CM  
Ø 1 IN<sup>5/16</sup> X 1 IN<sup>1/4</sup>



211397 +  
**PORTE SUCRE**  
CENTRE DE TABLE  
SUGAR HOLDER/TABLE  
CENTER PIECE  
CENTRO DE MESA  
Ø 6,4 X H 6 CM  
Ø 2 IN<sup>1/2</sup> X H 2 IN<sup>3/8</sup>



208862 +  
**PORTE SUCRE**  
CENTRE DE TABLE  
SUGAR HOLDER/TABLE  
CENTER PIECE  
CENTRO DE MESA  
Ø 5 X H 6 CM  
Ø 1 IN<sup>15/16</sup> X H 2 IN<sup>3/8</sup>





NEWPORT

CAFÉTERIE - COFFEEWARE - CAFETERA



213850 + 219563  
**VERSEUSE**  
COFFEE/TEA POT  
CAFETERA/TETERA  
1,5 L - 50 OZ<sup>3/4</sup>  
18,1 CM X H 22,4 CM  
7 IN<sup>1/8</sup> X H 8 IN<sup>3/16</sup>



213851 + 219564  
**VERSEUSE**  
COFFEE/TEA POT  
CAFETERA/TETERA  
70 CL - 23 OZ<sup>1/16</sup>  
14,8 CM X H 14,6 CM  
5 IN<sup>3/16</sup> X H 5 IN<sup>3/4</sup>



213852 + 219565  
**VERSEUSE**  
COFFEE/TEA POT  
CAFETERA/TETERA  
35 CL - 11 OZ<sup>13/16</sup>  
12,9 CM X H 9,3 CM  
5 IN<sup>1/16</sup> X H 3 IN<sup>1/16</sup>



213849 + 219561  
**PICHET**  
JUG  
JARRA  
2 L - 67 OZ<sup>5/8</sup>  
18,1 CM X H 23 CM  
7 IN<sup>1/8</sup> X H 9 IN<sup>1/16</sup>

POT ISOTHERME - INSULATED POT - JARRA ISOTÉRMICA



213846 + 219557  
**POT ISOTHERME**  
INSULATED POT  
JARRA ISOTÉRMICA  
1,2 L - 40 OZ<sup>9/16</sup>  
18,1 CM X H 22,7 CM  
7 IN<sup>1/8</sup> X H 8 IN<sup>15/16</sup>



213847 + 219558  
**POT ISOTHERME**  
INSULATED POT  
JARRA ISOTÉRMICA  
70 CL - 23 OZ<sup>1/3</sup>  
15,6 CM X H 19,2 CM  
6 IN<sup>1/8</sup> X H 7 IN<sup>9/16</sup>



213848 + 219559  
**POT ISOTHERME**  
INSULATED POT  
JARRA ISOTÉRMICA  
30 CL - 40 OZ  
13,4 CM X H 12,7 CM  
5 IN<sup>1/4</sup> X H 5 IN



**BEC VERSEUR ANTI GOUTTES**  
AN ANTI-SPILL  
UNA BOQUILLA ANTIGOTEO



213853 + 219566  
**CRÉMIER**  
CREAM JUG  
LECHERA  
35 CL - 11 OZ<sup>13/16</sup>  
12,9 CM X H 9 CM  
5 IN<sup>1/16</sup> X H 3 IN<sup>9/16</sup>



213854 + 219567  
**CRÉMIER**  
CREAM JUG  
LECHERA  
15 CL - 5 OZ<sup>1/16</sup>  
9 CM X H 9 CM  
3 IN<sup>9/16</sup> X H 3 IN<sup>9/16</sup>



182341 + 184612  
**SUCRIER**  
SUGAR BOWL  
LECHERA  
35 CL - 11 OZ<sup>13/16</sup>



NEWPORT P. 38-43



002191 + 129797  
**PINCE À SUCRE**  
SUGAR TONG  
PINZAS PARA AZÚCAR  
11,5 CM - 4 IN<sup>1/2</sup>



Photo non contractuelle





NEWPORT

BAR



184180 ✱ 188895 ✱  
**SEAU À CHAMPAGNE  
2 BOUTEILLES**  
CHAMPAGNE BUCKET 2 BOTTLES  
CHAMPANERA 2 BOTELLAS  
Ø 24 X H 25,5 CM  
Ø 9 IN<sup>7/16</sup> X H 10 IN<sup>17/16</sup>



186030 ✱ 188894 ✱  
**SEAU À CHAMPAGNE  
1 BOUTEILLE**  
CHAMPAGNE BUCKET 1 BOTTLE  
CHAMPANERA 1 BOTELLA  
Ø 20 X H 22,5 CM  
Ø 7 IN<sup>7/8</sup> X H 8 IN<sup>7/8</sup>



184181 ✱ 188896 ✱  
**SEAU À GLACE  
AVEC COUVERCLE**  
ICE BUCKET WITH LID  
CUBITERA CON TAPA  
Ø 15 X H 16 CM  
Ø 5 IN<sup>7/8</sup> X H 6 IN<sup>5/16</sup>

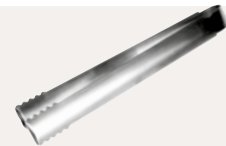

004014  
**PINCE À GLACE**  
ICE TONG  
PINZA PARA HIELO  
16 CM - 6 IN<sup>5/16</sup>

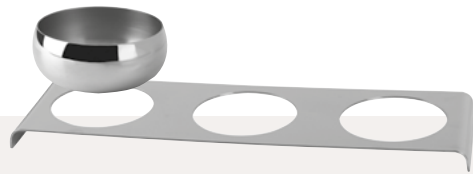

214185  
**COUPE ACIER**  
STAINLESS STEEL BOWL  
TAZÓN ACERO  
Ø 1,5 CM  
Ø 4 IN<sup>1/2</sup>

214182  
**PRÉSENTOIR ACIER 3 TROUS**  
THREE HOLES STAINLESS STEEL STAND  
MIRROR FINISH  
EXPOSITOR DE ACERO EN BRILLO 3 AGUJEROS  
41 X 12,5 X 2,3 CM  
16 IN<sup>1/8</sup> X 4 IN<sup>5/16</sup> X IN<sup>7/8</sup>

NEWPORT  
LOUNGE



NEW  
234320 ✱  
**DESSOUS DE BOUTEILLE**  
BOTTLE COASTER  
POSABOTELLA  
9,5 CM - 3 IN<sup>3/4</sup>



185607 ✱ 188893 ✱  
**PORTE SEAU À CHAMPAGNE  
(1 OU 2 BOUTEILLES)**  
CHAMPAGNE BUCKET STAND  
(1 OR 2 BOTTLES)  
PORTACUBO (1/2 BOTELLAS)  
H 63,5 CM - 25 IN



216919 ✱  
**VERRINE SEL AIMANTÉE**  
SALT CELLAR W/MAGNET  
SALERO CON IMÁN  
4,1 X 6,7 CM  
1 IN<sup>5/8</sup> X 2 IN<sup>5/8</sup>



216920 ✱  
**VERRINE POIVRE AIMANTÉE**  
PEPPER CELLAR W/MAGNET  
PIMENTERO CON IMÁN  
4,1 X 6,7 CM  
1 IN<sup>5/8</sup> X 2 IN<sup>5/8</sup>



216922 ✱  
**ENSEMBLE SEL & POIVRE  
AIMANTÉ**  
SALT & PEPPER CELLAR W/MAGNET  
CONJUNTO SALERO/PIMENTERO  
CON IMÁN  
8,5 X 10,6 CM  
3 IN<sup>3/8</sup> X 4 IN<sup>3/16</sup>



ACCESSOIRES - ACCESSORIES - ACCESORIOS



182614 + 184477  
**CLOCHE ASSIETTE**  
DOME COVER, STAINLESS STEEL  
CAMPANA  
Ø 24 CM - 9 IN<sup>7/8</sup>

182301 + 184476  
**CLOCHE ASSIETTE**  
DOME COVER, STAINLESS STEEL  
CAMPANA  
Ø 14,8 CM - 5 IN<sup>13/16</sup>



044113 + 101512  
**CLOCHE ASSIETTE**  
DOME COVER, STAINLESS STEEL  
CAMPANA  
Ø 26 CM - 10 IN<sup>1/4</sup>

044112 + 101510  
**CLOCHE ASSIETTE**  
DOME COVER, STAINLESS STEEL  
CAMPANA  
Ø 22 CM - 8 IN<sup>7/8</sup>



206504  
**BOUCHON PORCELAINE POUR CLOCHE VERRE**  
PORCELAIN LID FOR GLASS DOME COVER  
TAPA DE PORCELANA PARA CAMPANA DE VIDRIO  
5,2 CM - 2 IN<sup>7/8</sup>

204043  
**CLOCHE VERRE BOROSILICATE**  
GLASS DOME COVER  
CAMPANA VIDRIO BOROSILICATO  
17X9 CM - 6 IN<sup>11/16</sup> X 3 IN<sup>3/8</sup>



120522 + 131115  
**CORBEILLE À PAIN RONDE EN FIL**  
ROUND BREAD BASKET  
PANERA REDONDA  
Ø 20,5 X H 7,5 CM  
Ø 8 IN<sup>1/16</sup> X H 2 IN<sup>5/16</sup>



128910 + 131114  
**CORBEILLE À PAIN RONDE EN FIL**  
ROUND BREAD BASKET  
PANERA REDONDA  
Ø 17,5 X H 6 CM  
Ø 6 IN<sup>7/8</sup> X H 2 IN<sup>3/8</sup>

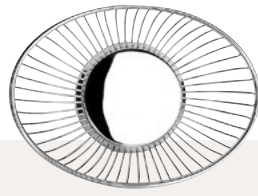

128912 + 131117  
**CORBEILLE À PAIN OVALE EN FIL**  
OVAL BREAD BASKET  
PANERA OVALADA  
Ø 24 X 17 CM - H 7,5 CM  
Ø 9 IN<sup>7/16</sup> X 6 IN<sup>11/16</sup> - H 2 IN<sup>15/16</sup>

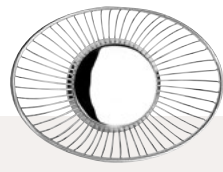

128911 + 131118  
**CORBEILLE À PAIN OVALE EN FIL**  
OVAL BREAD BASKET  
PANERA OVALADA  
Ø 20 X 15 CM - H 6 CM  
Ø 7 IN<sup>7/8</sup> X 5 IN<sup>7/8</sup> - H 2 IN<sup>3/8</sup>



159597 + 101453  
**BOL RINCE DOIGTS**  
FINGER BOWL  
LAVADEDOS  
Ø 11 X H 4 CM  
Ø 4 IN<sup>5/16</sup> X H 1 IN<sup>9/16</sup>

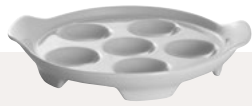

164138  
**PLAT À ESCARGOTS**  
SNAIL TRAY 6 SPACES  
BANDEJA CARACOLAS 6 COMPARTIMENTOS  
16,6 CM - 6 IN<sup>9/16</sup>



004013  
**PINCE À ESCARGOTS**  
SNAIL TONG  
PINZAS CARACOLAS  
16 CM - 6 IN<sup>5/16</sup>



204498 + 101492  
**PINCE À PAIN**  
BREAD TONG  
PINZAS PAN  
23 CM - 9 IN<sup>1/16</sup>



204497 + 101493  
**PINCE À HOMARD**  
LOBSTER CRACKER  
TENACILLAS PARA BOGAVANTE  
18,5 CM - 7 IN<sup>5/16</sup>



184492  
**PINCE À CRUSTACÉ**  
SEAFOOD CRACKER  
TENACILLAS PARA CRUSTACEOS  
16,5 CM - 6 IN<sup>1/2</sup>



204499 + 184355  
**PINCE À SERVIR**  
SERVING TONG  
PINZAS PARA SERVIR  
29,5 CM - 11 IN<sup>5/8</sup>



204496 + 101494  
**CISEAUX À GÂTEAUX**  
PASTRY CISSORS/TONG  
PINZAS PARA PASTELES  
20 CM - 7 IN<sup>7/8</sup>



130994  
**CUILLÈRE À TOASTS**  
APPETIZER SPOON  
CUCHARA APERITIVO  
11,8 CM - 7 IN<sup>7/16</sup>

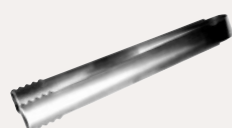

004014  
**PINCE À GLACE**  
ICE TONG  
PINZAS PARA HIELO  
16 CM - 6 IN<sup>5/16</sup>



002191 + 129797  
**PINCE À SUCRE**  
SUGAR TONG  
PINZA PARA AZÚCAR  
11,5 CM - 4 IN<sup>1/2</sup>



168845  
**CUILLÈRE À SPAGHETTI**  
SPAGHETTI SERVING SPOON  
CUCHARA PARA ESPAGUETIS  
29 CM - 11 IN<sup>7/16</sup>



168846  
**LOUCHETTE**  
GRAVY LADLE  
CUCHARÓN  
29 CM - 11 IN<sup>7/16</sup>



168844  
**FOURCHETTE À VIANDE**  
MEAT FORK  
TENEDOR DE CARNE  
29 CM - 11 IN<sup>7/16</sup>



168843  
**CUILLÈRE DE SERVICE**  
SERVING SPOON  
CUCHARA DE SERVICIO/ ENSALADA  
32 CM - 12 IN<sup>5/8</sup>







## VERRES

Les collections de verres DEGRENNE invitent au partage et à la dégustation. Leurs qualités esthétiques ainsi que leur résistance exceptionnelle, garantissent une utilisation en toute occasion. Pour choisir en toute simplicité le verre qui révélera tous les arômes du vin, découvrez Origine : cette collection composée de 5 verres à pied permet d'associer de manière évidente un vin avec le bon verre. Pour compléter harmonieusement la table, les verres de couleur DEGRENNE, teintés dans la masse, offrent une esthétique et une qualité à l'épreuve du temps et des lavages au lave-vaisselle. Soufflée bouche de manière artisanale, chaque pièce est unique !

### GLASSWARE

DEGRENNE'S glassware collections are an invitation to socialize and enjoy a drink. Our glassware's looks and exceptional sturdiness mean that it can be used at any occasion. Opt for Origine if you are looking for a glass to reveal all the flavour nuances of wine: this collection of five stemmed glasses makes it easy to combine wine with the right glass. DEGRENNE's integrally dyed glasses are a harmonious addition to the dining table and offer looks and quality that withstand the test of time and repeated washing in the dishwasher. Each hand-blown glass is unique!

### CRISTALERÍA

Las colecciones de copas DEGRENNE invitan a compartir y a degustar. Sus cualidades estéticas así como su resistencia, excepcional, garantizan un uso en cualquier ocasión. Para elegir con total sencillez la copa que revele todos los aromas del vino, descubra Origine: esta colección compuesta por 5 copas de vino permite asociar de manera evidente un vino con la copa adecuada. Para completar la mesa con armonía, las copas de color DEGRENNE, pintadas en masa, ofrecen una estética y una calidad que supera el paso del tiempo y los lavados en el lavavajillas. Soplada en boca de manera artesanal, ¡cada pieza es única !







184584  
**FLÛTE À CHAMPAGNE**  
CHAMPAGNE FLÛTE  
FLAUTA CHAMPÁN  
27 CL - 9 OZ<sup>1/8</sup>  
Ø 8 X H 24,3 CM  
Ø 3 IN<sup>1/8</sup> X H 9 IN<sup>5/16</sup>



184583  
**VERRE À VIN BLANC**  
WHITE WINE GLASS  
COPA DE VINO BLANCO  
35 CL - 11 OZ<sup>1/16</sup>  
Ø 8 X H 22,3 CM  
Ø 3 IN<sup>1/8</sup> X H 8 IN<sup>3/4</sup>



184582  
**VERRE À VIN ROUGE**  
RED WINE GLASS  
COPA DE VINO TINTO  
42 CL - 14 OZ<sup>1/16</sup>  
Ø 8,3 X H 23,1 CM  
Ø 3 IN<sup>1/4</sup> X H 9 IN<sup>1/8</sup>



184581  
**VERRE À EAU**  
WATER GLASS  
COPA DE AGUA  
48 CL - 16 OZ<sup>1/4</sup>  
Ø 8,9 X H 23,5 CM  
Ø 3 IN<sup>1/2</sup> X H 9 IN<sup>1/4</sup>







184551  
**FLÛTE À CHAMPAGNE**  
CHAMPAGNE FLÛTE  
FLAUTA CHAMPÁN  
19 CL - 6 OZ<sup>7/16</sup>  
Ø 6,3 X H 22,4 CM  
Ø 2 IN<sup>1/2</sup> X H 8 IN<sup>3/16</sup>

184549  
**VERRE À VIN BLANC**  
WHITE WINE GLASS  
COPA DE VINO BLANCO  
28 CL - 9 OZ<sup>7/16</sup>  
Ø 7,4 X H 20,8 CM  
Ø 2 IN<sup>5/16</sup> X H 8 IN<sup>3/16</sup>

184548  
**VERRE À VIN ROUGE**  
RED WINE GLASS  
COPA DE VINO TINTO  
35 CL - 11 OZ<sup>13/16</sup>  
Ø 8 X H 21,4 CM  
Ø 3 IN<sup>1/8</sup> X H 8 IN<sup>7/16</sup>

184547  
**VERRE À EAU**  
WATER GLASS  
COPA DE AGUA  
45 CL - 15 OZ<sup>3/16</sup>  
Ø 8,4 X H 22,5 CM  
Ø 3 IN<sup>5/16</sup> X H 8 IN<sup>1/16</sup>

184550  
**VERRE À BORDEAUX**  
BORDEAUX GLASS  
COPA DE CAVA  
64,5 CL - 21 OZ<sup>13/16</sup>  
Ø 9,5 X H 23,8 CM  
Ø 3 IN<sup>3/4</sup> X H 9 IN<sup>3/16</sup>

210812  
**VERRE À BOURGOGNE**  
BURGUNDY GLASS  
COPA BOURGOGNE  
70 CL - 23 OZ<sup>11/16</sup>  
Ø 10,5 X H 23,1 CM  
Ø 4 IN<sup>1/8</sup> X H 9 IN<sup>1/8</sup>



184555  
**GOBELET HAUT**  
HIGH TUMBLER  
VASO ALTO  
36 CL - 12 OZ<sup>3/16</sup>  
Ø 6,8 X H 14,2 CM  
Ø 2 IN<sup>11/16</sup> X H 5 IN<sup>9/16</sup>



184554  
**GOBELET BAS**  
LOW TUMBLER  
VASO BAJO  
33 CL - 11 OZ<sup>3/16</sup>  
Ø 8 X H 10,2 CM  
Ø 3 IN<sup>1/8</sup> X H 4 IN



184553  
**GOBELET BAS**  
LOW TUMBLER  
VASO BAJO  
23 CL - 7 OZ<sup>3/4</sup>  
Ø 7,6 X H 9,2 CM  
Ø 3 IN X H 3 IN<sup>5/8</sup>



184552  
**GOBELET BAS/VERRINE**  
LOW TUMBLER/APPETIZER GLASS  
VASO BAJO/VASITOS  
15 CL - 5 OZ<sup>7/16</sup>  
Ø 6,4 X H 8 CM  
Ø 2 IN<sup>1/2</sup> X H 3 IN<sup>1/8</sup>



©Patrick ROUGEREAU

L'ABUS D'ALCOOL EST DANGEREUX POUR LA SANTÉ  
DEGRENNÉ PROMOTES RESPONSIBLE DRINKING AND DISCOURAGES ALCOHOL MISUSE  
EL ABUSO DE ALCOHOL ES PELIGROSO PARA LA SALUD







184556  
**FLÛTE À CHAMPAGNE**  
CHAMPAGNE FLÛTE  
FLAUTA CHAMPÁN  
20 CL - 6 OZ<sup>3/4</sup>  
Ø 6,7 X H 21,2 CM  
Ø 2 IN<sup>5/16</sup> X H 8 IN<sup>3/8</sup>



190537  
**VERRE À VIN**  
WINE GLASS  
COPA DE VINO  
35 CL - 11 OZ<sup>13/16</sup>  
Ø 7,8 X H 19,6 CM  
Ø 3 IN<sup>7/16</sup> X H 7 IN<sup>11/16</sup>



190536  
**VERRE À EAU**  
WATER GLASS  
COPA DE AGUA  
45 CL - 15 OZ<sup>3/16</sup>  
Ø 8,4 X H 20,5 CM  
Ø 3 IN<sup>5/16</sup> X H 8 IN<sup>1/16</sup>



190538  
**GOBELET**  
TUMBLER  
VASO  
47 CL - 15 OZ<sup>7/8</sup>  
Ø 8,5 X H 12,1 CM  
Ø 3 IN<sup>3/16</sup> X H 4 IN<sup>3/4</sup>



DÉCOR TAILLÉ DANS LE VERRE  
CUT-GLASS DESIGN  
DECORACIÓN TALLADA EN CRISTAL







À CHAQUE VERRE SON VIN - A GLASS FOR EACH AND EVERY WINE - UN VASO PARA CADA VINO

DEGRENNÉ S'EST ASSOCIÉ À **MANUEL PEYRONDET**, MEILLEUR OUVRIER DE FRANCE SOMMELIER 2013 POUR CRÉER **ORIGINE**, LA PREMIÈRE GAMME DE 5 VERRES À PIED PERMETTANT D'ASSOCIER DE MANIÈRE SIMPLE ET ÉVIDENTE UN VIN AVEC LE BON VERRE.



DEGRENNÉ HAS JOINED FORCES WITH **MANUEL PEYRONDET**, THE 2013 WINNER OF THE PRESTIGIOUS MEILLEUR OUVRIER DE FRANCE SOMMELIER AWARD, TO CREATE **ORIGINE**, THE FIRST RANGE OF FIVE STEMMED GLASSES, MAKING IT EASY TO CHOOSE THE RIGHT GLASS FOR YOUR WINE.

DEGRENNÉ SE HA ASOCIADO CON **MANUEL PEYRONDET**, EL MEJOR OBRADOR DE FRANCIA SUMILLER DE 2013 PARA CREAR **ORIGINE**, LA PRIMERA GAMA DE 5 COPAS DE VINO, QUE PERMITE ASOCIAR DE MANERA SENCILLA Y EVIDENTE UN VINO CON LA COPA ADECUADA.

N°1

CHAMPAGNE  
PROSECCO



216733  
**EFFERVESCENCE**  
EFFERVESCENCE  
ESPUMA  
22,5 CL - 7 OZ<sup>5/8</sup>  
Ø 7,1 X H 21 CM  
Ø 2 IN<sup>3/16</sup> X H 8 IN<sup>1/4</sup>

N°2

RIESLING, SAUVIGNON,  
CHENIN, GAMAY,  
CABERNET, FRANC



216730  
**FRAÎCHEUR**  
FRESHNESS  
FRESQUERA  
50 CL - 16 OZ<sup>5/16</sup>  
Ø 8,9 X H 21,5 CM  
Ø 3 IN<sup>1/2</sup> X H 8 IN<sup>7/16</sup>

N°3

GRENACHE, MERLOT,  
MALBEC, SYRHA  
CABERNET SAUVIGNON



216731  
**PUISSANCE**  
STRENGTH  
POTENCIA  
50 CL - 16 OZ<sup>5/16</sup>  
Ø 9,5 X H 21,5 CM  
Ø 3 IN<sup>3/4</sup> X H 8 IN<sup>7/16</sup>

N°4

PINOT NOIR,  
CHARDONNAY,  
BOURGOGNE



216732  
**SUBTILITÉ**  
SUBTLETY  
SUTILEZA  
60 CL - 20 OZ<sup>5/16</sup>  
Ø 10,2 X H 21,5 CM  
Ø 4 IN X H 8 IN<sup>7/16</sup>

N°5

POUR LES VINS MOELLEUX ET LIQUEUREUX  
FOR SWEET & SYRUPY WINES  
PARA LOS VINOS MELOSOS  
Y LICOROSOS



216734  
**DOUCEUR**  
SWEETNESS  
DULZOR  
20 CL - 6 OZ<sup>3/4</sup>  
Ø 6,9 X H 20 CM  
Ø 2 IN<sup>11/16</sup> X H 7 IN<sup>7/16</sup>

**OUVERTURE DU BUVANT**  
THE OPENING OF THE RIM  
LA APERTURA DE LA BOCA



**POUR AFFIRMER LA TEXTURE DU VIN**  
AFFIRM THE WINE'S TEXTURE  
PARA AFIRMAR LA TEXTURA DEL VINO

**HAUTEUR DE PARAISSON**  
THE HEIGHT OF THE BULB  
LA ALTURA DEL FONDO



**POUR JOUER SUR L'EXPANSION DES BOUQUETS**  
ALLOW THE BOUQUETS TO FLOURISH  
PARA JUGAR SOBRE LA AMPLIACIÓN DE LOS BUQUÉS

**DIAMÈTRE DE PARAISSON**  
THE DIAMETER OF THE BULB  
EL DIÁMETRO DEL FONDO



**POUR LAISSER LE VIN S'OXYGÉNER**  
ALLOW THE WINE TO AERATE  
PARA DEJAR QUE EL VINO OXIGENE

**3 LEVIERS ONT ÉTÉ IDENTIFIÉS**  
3 KEY FACTORS WERE IDENTIFIED  
SE HAN IDENTIFICADO 3 PARÁMETROS

**HAUTEUR COMPATIBLE LAVE-VAISSELLE**  
DISHWASHER COMPATIBLE HEIGHT  
ALTURA COMPATIBLE CON LAVA-VAJILLAS

**SERVICE FACILITÉ PAR LA JAUGE NATURELLE DE 12 CL**  
SERVICE IS FACILITATED BY THE 12 CL MARKING  
SERVICIO FACILITADO POR EL INDICADOR DE NIVEL NATURAL DE 12 CL



LA VERRERIE  
GLASSWARE - CRISTALERÍA





184566  
**FLÛTE À CHAMPAGNE**  
CHAMPAGNE FLÛTE  
FLAUTA CHAMPÁN  
19 CL - 6 OZ<sup>7/8</sup>  
Ø 5,3 X H 21,9 CM  
Ø 2 IN<sup>7/16</sup> X H 8 IN<sup>5/8</sup>

184563  
**VERRE À VIN BLANC**  
WHITE WINE GLASS  
COPA DE VINO BLANCO  
28 CL - 9 OZ<sup>7/8</sup>  
Ø 7,3 X H 21,2 CM  
Ø 2 IN<sup>7/8</sup> X H 8 IN<sup>3/8</sup>

184562  
**VERRE À VIN ROUGE**  
RED WINE GLASS  
COPA DE VINO TINTO  
37 CL - 12 OZ<sup>1/2</sup>  
Ø 7,7 X H 21,4 CM  
Ø 3 IN<sup>7/8</sup> X H 8 IN<sup>7/8</sup>

184561  
**VERRE À EAU**  
WATER GLASS  
COPA DE AGUA  
49,5 CL - 16 OZ<sup>3/4</sup>  
Ø 8,6 X H 22,7 CM  
Ø 3 IN<sup>3/8</sup> X H 8 IN<sup>5/8</sup>

184564  
**VERRE À BORDEAUX**  
BORDEAUX GLASS  
COPA DE CAVA  
65 CL - 22 OZ  
Ø 9,4 X H 23,9 CM  
Ø 3 IN<sup>11/16</sup> X H 9 IN<sup>7/8</sup>

184565  
**VERRE À BOURGOGNE**  
BURGUNDY GLASS  
COPA BOURGOGNE  
75 CL - 25 OZ<sup>3/8</sup>  
Ø 10,7 X H 22,5 CM  
Ø 4 IN<sup>3/8</sup> X H 8 IN<sup>7/8</sup>







184580  
**FLÛTE À CHAMPAGNE**  
CHAMPAGNE FLÛTE  
FLAUTA CHAMPÁN  
21 CL - 7 OZ<sup>1/8</sup>  
Ø 7 X H 21 CM  
Ø 2 IN<sup>3/4</sup> X H 8 IN<sup>1/4</sup>

184578  
**VERRE À VIN**  
WINE GLASS  
COPA DE VINO  
20 CL - 6 OZ<sup>1/4</sup>  
Ø 7 X H 17,4 CM  
Ø 2 IN<sup>3/4</sup> X H 6 IN<sup>7/8</sup>

184577  
**VERRE À VIN BLANC**  
WHITE WINE GLASS  
COPA DE VINO BLANCO  
25 CL - 8 OZ<sup>7/8</sup>  
Ø 7,5 X H 18,4 CM  
Ø 2 IN<sup>5/8</sup> X H 7 IN<sup>1/4</sup>

184576  
**VERRE À VIN ROUGE**  
RED WINE GLASS  
COPA DE VINO TINTO  
32 CL - 10 OZ<sup>13/16</sup>  
Ø 7,8 X H 19,8 CM  
Ø 3 IN<sup>7/8</sup> X H 7 IN<sup>3/8</sup>

184575  
**VERRE À EAU**  
WATER GLASS  
COPA DE AGUA  
42 CL - 14 OZ<sup>1/8</sup>  
Ø 8,7 X H 20,5 CM  
Ø 3 IN<sup>7/8</sup> X H 8 IN<sup>1/8</sup>

184579  
**VERRE À BOURGOGNE**  
BURGUNDY GLASS  
COPA BOURGOGNE  
58 CL - 19 OZ<sup>5/8</sup>  
Ø 10 X H 20 CM  
Ø 3 IN<sup>5/8</sup> X H 7 IN<sup>7/8</sup>

MONTMARTRE  
JAUGÉ



14 CL - 4 oz<sup>3/4</sup>  
12,5 CL - 4 oz<sup>1/4</sup>

208481  
**VERRE À VIN ROUGE AVEC DOUBLE JAUGE**  
RED WINE GLASS WITH 2 GAUGE  
COPA DE VINO TINTO  
CON DOBLE INDICATOR  
32 CL - 10 OZ<sup>13/16</sup>  
Ø 7,8 X H 19,8 CM  
Ø 3 IN<sup>7/8</sup> X H 7 IN<sup>3/8</sup>

HYPNOTIC  
JAUGÉ **NEW**



213816  
**VERRE À VIN AVEC DOUBLE JAUGE**  
RED WINE GLASS WITH 2 GAUGE  
COPA DE VINO TINTO  
CON DOBLE INDICATOR  
36,5 CL - 13 OZ  
Ø 8,2 X H 22 CM  
Ø 3 IN<sup>1/4</sup> X H 8 IN<sup>11/16</sup>

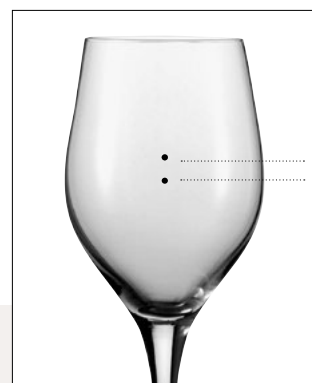

**AVEC DOUBLE JAUGE**  
WITH 2 GAUGE  
CON DOBLE INDICATOR  
14 CL - 4 oz<sup>3/4</sup>  
12,5 CL - 4 oz<sup>1/4</sup>







234148  
**CARAFE**  
PITCHER  
BOTELLA  
75 CL - 25 OZ<sup>3/8</sup>  
Ø 9,1 X H 24 CM  
Ø 3 IN<sup>9/16</sup> X H 4 IN<sup>3/8</sup>



234149  
**VERRE À PIED**  
STEMMED GLASS  
COPA  
26 CL - 8 OZ<sup>3/4</sup>  
Ø 7,9 X H 11,1 CM  
Ø 3 IN<sup>9/16</sup> X H 4 IN<sup>3/8</sup>



234150  
**GOBELET**  
TUMBLER  
VASO  
26 CL - 8 OZ<sup>3/4</sup>  
Ø 7,1 X H 9,1 CM  
Ø 2 IN<sup>13/16</sup> X H 3 IN<sup>9/16</sup>



234151  
**VERRE À TAPAS**  
TAPAS GLASS  
VASO DE TAPAS  
17 CL - 5 OZ<sup>3/4</sup>  
Ø 7,9 X H 6,3 CM  
Ø 3 IN<sup>9/16</sup> X H 2 IN<sup>1/2</sup>



VERRES EMPILABLES  
STACKABLE GLASSES  
VASOS APILABLES

L'ABUS D'ALCOOL EST DANGEREUX POUR LA SANTÉ  
DEGRENE PROMOTES RESPONSIBLE DRINKING AND DISCOURAGES ALCOHOL MISUSE  
EL ABUSO DE ALCOHOL ES PELIGROSO PARA LA SALUD



©Patrick ROUGEREAU





# CARAFES DÉCANTEURS



169728  
**DÉCANTEUR MILLÉSIME**  
DECANTER  
DECANTADOR  
1,35 L - 45 OZ<sup>5/8</sup>  
Ø 20,5 X H 23,5 CM  
Ø 8 IN<sup>7/16</sup> X H 9 IN<sup>1/4</sup>



188969  
**DÉCANTEUR VINDÉMIA**  
DECANTER  
DECANTADOR  
1,35 L - 45 OZ<sup>5/8</sup>  
Ø 23 X H 24 CM  
Ø 9 IN<sup>7/16</sup> X H 9 IN<sup>7/16</sup>



210904  
**DÉCANTEUR NECTAR**  
DECANTER  
DECANTADOR  
1 L - 33 OZ<sup>13/16</sup>  
Ø 13,5 X H 24,5 CM  
Ø 5 IN<sup>5/16</sup> X H 9 IN<sup>5/16</sup>



199027  
**CARAFE À WHISKY  
ANYTIME**  
WHISKY CARAFE  
JARRA DE WHISKY  
1,2 L - 40 OZ<sup>3/16</sup>  
Ø 9,5 X H 26 CM  
Ø 3 IN<sup>3/4</sup> X H 10 IN<sup>1/4</sup>



202639  
**CARAFE À JUS  
DE FRUITS  
EVENTO**  
JUICE/BEVERAGE CARAFE  
BOTELLA PARA ZUMOS  
1,2 L - 40 OZ<sup>3/16</sup>  
Ø 10,5 X H 27,5 CM  
Ø 4 IN<sup>1/8</sup> X H 10 IN<sup>13/16</sup>



202855  
**BOUCHON DE  
CARAFE SILICONE  
EVENTO**  
SILICONE STOPPER  
FOR CARAFE  
TAPÓN PARA BOTELLA  
SILICONA  
Ø 6,5 CM - 2 IN<sup>9/16</sup>



**NEW**  
234148  
**CARAFE  
EMPILEO**  
PITCHER  
BOTELLA  
75 CL - 25 OZ<sup>3/8</sup>  
Ø 9,1 X H 24 CM  
Ø 3 IN<sup>9/16</sup> X H 4 IN<sup>3/8</sup>





CHAMPAGNE - CHAMPÁN



184567  
**FLÛTE À CHAMPAGNE**  
CHAMPAGNE FLÛTE  
FLAUTA CHAMPÁN  
15 CL - 5 OZ<sup>1/8</sup>  
Ø 6,3 X H 19,3 CM  
Ø 2 IN<sup>1/2</sup> X H 7 IN<sup>5/8</sup>



184567  
**VERRE À CHAMPAGNE**  
CHAMPAGNE GLASS  
FLAUTA CHAMPÁN  
21 CL - 7 OZ<sup>1/8</sup>  
Ø 6,8 X H 20,5 CM  
Ø 2 IN<sup>11/16</sup> X H 8 IN<sup>1/8</sup>



210281  
**COUPE À CHAMPAGNE**  
CHAMPAGNE GLASS  
COPA CHAMPÁN  
23 CL - 7 OZ<sup>3/4</sup>  
Ø 9,5 X H 14,7 CM  
Ø 3 IN<sup>3/4</sup> X H 5 IN<sup>13/16</sup>

BIÈRE - BEER - CERVEZA



184569  
**VERRE À BIÈRE**  
BEER GLASS  
VASO CERVEZA  
39 CL - 13 OZ<sup>3/16</sup>  
Ø 7,3 X H 17,7 CM  
Ø 2 IN<sup>7/8</sup> X H 6 IN<sup>15/16</sup>

COCKTAILS - COCTELES



195628  
**VERRE À MARTINI**  
MARTINI GLASS  
COPA DE MARTINI  
25 CL - 8 OZ<sup>7/16</sup>  
Ø 10,6 X H 16,8 CM  
Ø 4 IN<sup>3/16</sup> X H 6 IN<sup>5/8</sup>



209814  
**VERRE À MARGARITA**  
MARGARITA GLASS  
COPA DE MARGARITA  
34 CL - 11 OZ<sup>1/2</sup>  
Ø 11,1 X H 17,2 CM  
Ø 4 IN<sup>3/8</sup> X H 6 IN<sup>1/4</sup>



209815  
**VERRE À COCKTAIL**  
COCKTAIL GLASS  
COPA COCKTAIL  
48 CL - 16 OZ<sup>1/4</sup>  
Ø 8 X H 20,9 CM  
Ø 3 IN<sup>1/8</sup> X H 8 IN<sup>1/4</sup>

DIGESTIF - LIQUEUR WINE - DIGESTIVOS



184570  
**VERRE À COGNAC**  
COGNAC GLASS  
VASO COÑAC  
61 CL - 20 OZ<sup>5/8</sup>  
Ø 10,4 X H 15,5 CM  
Ø 4 IN<sup>1/8</sup> X H 6 IN<sup>5/8</sup>



190700  
**VERRE À PORTO/  
SHERRY**  
SHERRY GLASS  
COPA JEREZ/OPORTO  
10,4 CL - 3 OZ<sup>1/2</sup>  
Ø 5,6 X H 16,9 CM  
Ø 2 IN<sup>5/16</sup> X H 6 IN<sup>5/8</sup>



209813  
**VERRE À SHOOTER**  
SHOT GLASS  
COPA SHOOTER  
4,5 CL - 1 OZ<sup>1/2</sup>  
Ø 4,6 X H 8 CM  
Ø 1 IN<sup>15/16</sup> X H 3 IN<sup>1/8</sup>

VERRINES - APPETIZER GLASSES - VASITOS



181874  
**VERRINE RONDO**  
APPETIZER GLASS  
VASITO  
13 CL - 4 OZ<sup>1/8</sup>  
Ø 5,5 X H 6 CM  
Ø 2 IN<sup>3/16</sup> X H 2 IN<sup>3/8</sup>



109439  
**COUPELLE BRAZIL**  
APPETIZER GLASS  
VASO  
30 CL - 10 OZ<sup>1/8</sup>  
Ø 13,2 X H 8,7 CM  
Ø 5 IN<sup>37/16</sup> X H 3 IN<sup>7/16</sup>



210811  
**OSLO BOL**  
BOWL  
COPA/VASITO  
30 CL - 10 OZ<sup>1/8</sup>





# MUSE



184555  
**GOBELET HAUT**  
HIGH TUMBLER  
VASO ALTO  
36 CL - 12 OZ<sup>3/16</sup>  
Ø 6,8 X H 14,2 CM  
Ø 2 IN<sup>11/16</sup> X H 5 IN<sup>9/16</sup>



184554  
**GOBELET BAS**  
LOW TUMBLER  
VASO BAJO  
33 CL - 11 OZ<sup>3/16</sup>  
Ø 8 X H 10,2 CM  
Ø 3 IN<sup>11/8</sup> X H 4 IN



184553  
**GOBELET BAS**  
LOW TUMBLER  
VASO BAJO  
23 CL - 7 OZ<sup>3/4</sup>  
Ø 7,6 X H 9,2 CM  
Ø 3 IN X H 3 IN<sup>5/8</sup>



184552  
**GOBELET BAS/VERRINE**  
LOW TUMBLER/APPETIZER  
GLASS  
VASO BAJO/VASITOS  
15 CL - 5 OZ<sup>1/16</sup>  
Ø 6,4 X H 8 CM  
Ø 2 IN<sup>1/2</sup> X H 3 IN<sup>1/8</sup>



184601  
**GOBELET HAUT**  
HIGH TUMBLER  
VASO ALTO  
39 CL - 13 OZ<sup>3/16</sup>  
Ø 6,6 X H 14,5 CM  
Ø 2 IN<sup>5/8</sup> X H 5 IN<sup>11/16</sup>



184600  
**GOBELET BAS**  
LOW TUMBLER  
VASO BAJO  
35 CL - 11 OZ<sup>13/16</sup>  
Ø 7,9 X H 9,1 CM  
Ø 3 IN<sup>11/8</sup> X H 3 IN<sup>9/16</sup>



184598  
**GOBELET BAS/VERRINE**  
LOW TUMBLER/APPETIZER  
GLASS  
VASO BAJO/VASITOS  
19 CL - 6 OZ<sup>7/16</sup>  
Ø 6,7 X H 8,1 CM  
Ø 2 IN<sup>5/8</sup> X H 3 IN<sup>3/16</sup>



# LOOP



184589  
**GOBELET HAUT**  
HIGH TUMBLER  
VASO ALTO  
35 CL - 11 OZ<sup>13/16</sup>  
Ø 6,5 X H 14,4 CM  
Ø 2 IN<sup>5/16</sup> X H 5 IN<sup>11/16</sup>



184588  
**GOBELET HAUT**  
HIGH TUMBLER  
VASO ALTO  
29 CL - 9 OZ<sup>13/16</sup>  
Ø 7 X H 10,7 CM  
Ø 2 IN<sup>3/4</sup> X H 4 IN<sup>3/16</sup>



189774  
**GOBELET BAS**  
LOW TUMBLER  
VASO BAJO  
42 CL - 14 OZ<sup>2/16</sup>  
Ø 8,5 X H 10,6 CM  
Ø 3 IN<sup>3/8</sup> X H 4 IN<sup>3/16</sup>



184586  
**GOBELET BAS**  
LOW TUMBLER  
VASO BAJO  
32 CL - 10 OZ<sup>13/16</sup>  
Ø 8 X H 9,4 CM  
Ø 3 IN<sup>1/8</sup> X H 3 IN<sup>11/16</sup>



# COSMOPOLITAIN





DOLCE



VERRES SOUFFLÉS BOUCHE TEINTÉS DANS LA MASSE  
HAND-BLOWN INTEGRALLY DYED GLASSES  
VASOS SOPLADOS A BOCA, PINTADOS EN MASA



169851  
**Gobelet Haut  
Transparent**  
Transparent High Tumbler  
Vaso Alto Transparent  
57 CL - 19 OZ<sup>1/4</sup>  
Ø 6,7 X H 11,5 CM  
Ø 2 IN<sup>5/8</sup> X H 4 IN<sup>1/2</sup>



169852  
**Gobelet Bas  
Transparent**  
Transparent Low Tumbler  
Vaso Bajo Transparent  
43 CL - 14 OZ<sup>2/16</sup>  
Ø 6,1 X H 10 CM  
Ø 2 IN<sup>3/8</sup> X H 3 IN<sup>15/16</sup>



169854  
**Gobelet Bas  
Mauve**  
Purple Low Tumbler  
Vaso Bajo Malva  
43 CL - 14 OZ<sup>2/16</sup>  
Ø 6,1 X H 10 CM  
Ø 2 IN<sup>3/8</sup> X H 3 IN<sup>15/16</sup>



169856  
**Gobelet Bas  
Gris**  
Grey Low Tumbler  
Vaso Bajo Gris  
43 CL - 14 OZ<sup>2/16</sup>  
Ø 6,1 X H 10 CM  
Ø 2 IN<sup>3/8</sup> X H 3 IN<sup>15/16</sup>



231470  
**Gobelet Bas  
Transparent Sablé**  
Transparent Sand Low Tumbler  
Vaso Bajo Transparent Arena  
43 CL - 14 OZ<sup>2/16</sup>  
Ø 6,1 X H 10 CM  
Ø 2 IN<sup>3/8</sup> X H 3 IN<sup>15/16</sup>



VERRES SOUFFLÉS BOUCHE TEINTÉS DANS LA MASSE  
HAND-BLOWN INTEGRALLY DYED GLASSES  
VASOS SOPLADOS A BOCA, PINTADOS EN MASA



**NEW**  
234489  
**Gobelet  
Transparent**  
Transparent Tumbler  
Vaso Transparent  
40 CL - 13 OZ<sup>1/2</sup>  
Ø 8 X H 12,1 CM  
Ø 3 IN<sup>1/8</sup> X H 4 IN<sup>3/4</sup>



206936  
**Gobelet  
Transparent**  
Transparent Tumbler  
Vaso Transparent  
29 CL - 9 OZ<sup>13/16</sup>  
Ø 7,2 X H 9,5 CM  
Ø 2 IN<sup>13/16</sup> X H 3 IN<sup>3/4</sup>



**NEW**  
234491  
**Gobelet  
Gris**  
Grey Tumbler  
Vaso Gris  
40 CL - 13 OZ<sup>1/2</sup>  
Ø 8 X H 12,1 CM  
Ø 3 IN<sup>1/8</sup> X H 4 IN<sup>3/4</sup>



225517  
**Gobelet  
Gris**  
Grey Tumbler  
Vaso Gris  
29 CL - 9 OZ<sup>13/16</sup>  
Ø 7,2 X H 9,5 CM  
Ø 2 IN<sup>13/16</sup> X H 3 IN<sup>3/4</sup>



**NEW**  
234490  
**Gobelet  
Bleu Nuit**  
Blue Night Tumbler  
Vaso Azul  
40 CL - 13 OZ<sup>1/2</sup>  
Ø 8 X H 12,1 CM  
Ø 3 IN<sup>1/8</sup> X H 4 IN<sup>3/4</sup>



199461  
**Gobelet  
Bleu Nuit**  
Blue Night Tumbler  
Vaso Azul  
29 CL - 9 OZ<sup>13/16</sup>  
Ø 7,2 X H 9,5 CM  
Ø 2 IN<sup>13/16</sup> X H 3 IN<sup>3/4</sup>



180939  
**Gobelet  
Blanc**  
White Tumbler  
Vaso Blanco  
29 CL - 9 OZ<sup>13/16</sup>  
Ø 7,2 X H 9,5 CM  
Ø 2 IN<sup>13/16</sup> X H 3 IN<sup>3/4</sup>



225516  
**Gobelet  
Rouge**  
Red Tumbler  
Vaso Rojo  
29 CL - 9 OZ<sup>13/16</sup>  
Ø 7,2 X H 9,5 CM  
Ø 2 IN<sup>13/16</sup> X H 3 IN<sup>3/4</sup>



180936  
**Gobelet  
Noir**  
Black Tumbler  
Vaso Negro  
29 CL - 9 OZ<sup>13/16</sup>  
Ø 7,2 X H 9,5 CM  
Ø 2 IN<sup>13/16</sup> X H 3 IN<sup>3/4</sup>



199462  
**Gobelet  
Vert Pomme**  
Apple Green Tumbler  
Vaso Verde  
29 CL - 9 OZ<sup>13/16</sup>  
Ø 7,2 X H 9,5 CM  
Ø 2 IN<sup>13/16</sup> X H 3 IN<sup>3/4</sup>



174510  
**Gobelet  
Cassis**  
Purple Tumbler  
Vaso Púrpura  
29 CL - 9 OZ<sup>13/16</sup>  
Ø 7,2 X H 9,5 CM  
Ø 2 IN<sup>13/16</sup> X H 3 IN<sup>3/4</sup>

ALLEGRO





MAMBO



VERRES SOUFFLÉS BOUCHE TEINTÉS DANS LA MASSE  
HAND-BLOWN INTEGRALLY DYED GLASSES  
VASOS SOPLADOS A BOCA, PINTADOS EN MASA



171631  
**GOBELET GRIS**  
GREY TUMBLER  
VASO GRIS  
34 CL - 11 OZ<sup>1/2</sup>  
Ø 8,5 X H 10 CM  
Ø 3 IN<sup>3/8</sup> X H 3 IN<sup>15/16</sup>



171632  
**GOBELET VERT**  
GREEN TUMBLER  
VASO VERDE  
34 CL - 11 OZ<sup>1/2</sup>  
Ø 8,5 X H 10 CM  
Ø 3 IN<sup>3/8</sup> X H 3 IN<sup>15/16</sup>



171633  
**GOBELET VIOLET**  
PURPLE TUMBLER  
VASO VIOLETA  
34 CL - 11 OZ<sup>1/2</sup>  
Ø 8,5 X H 10 CM  
Ø 3 IN<sup>3/8</sup> X H 3 IN<sup>15/16</sup>



171630  
**GOBELET ROUGE**  
RED TUMBLER  
VASO ROJO  
34 CL - 11 OZ<sup>1/2</sup>  
Ø 8,5 X H 10 CM  
Ø 3 IN<sup>3/8</sup> X H 3 IN<sup>15/16</sup>



VERRES SOUFFLÉS BOUCHE TEINTÉS DANS LA MASSE  
HAND-BLOWN INTEGRALLY DYED GLASSES  
VASOS SOPLADOS A BOCA, PINTADOS EN MASA



**NEW**  
235133  
**GOBELET ARGILE VERTE**  
GREEN CLAY TUMBLER  
VASO ARCILLA VERDE  
30 CL - 10 OZ<sup>1/8</sup>  
Ø 8,8 X H 8,8 CM  
Ø 3 IN<sup>7/16</sup> X H 3 IN<sup>7/16</sup>



230891  
**GOBELET GRIS**  
GREY TUMBLER  
VASO GRIS  
30 CL - 10 OZ<sup>1/8</sup>  
Ø 8,8 X H 8,8 CM  
Ø 3 IN<sup>7/16</sup> X H 3 IN<sup>7/16</sup>



230890  
**GOBELET SABLE ROSE**  
PINK TUMBLER  
VASO ROSE  
30 CL - 10 OZ<sup>1/8</sup>  
Ø 8,8 X H 8,8 CM  
Ø 3 IN<sup>7/16</sup> X H 3 IN<sup>7/16</sup>



230889  
**GOBELET BLEU DE ROCHE**  
BLUE TUMBLER  
VASO AZUL  
30 CL - 10 OZ<sup>1/8</sup>  
Ø 8,8 X H 8,8 CM  
Ø 3 IN<sup>7/16</sup> X H 3 IN<sup>7/16</sup>



VERRES EMPILABLES  
STACKABLE GLASSES  
VASOS APILABLES



BILBAO







## LE BUFFET EVENTO

**D**u petit-déjeuner au dîner, des buffets sucrés aux buffets salés, la collection **EVENTO** répond à tous les scénarios de réception. Un design **homogène, harmonieux, fonctionnel et modulable**. La **richesse de ses combinaisons** et la **diversité de ses matériaux** (acier, porcelaine, verre, grès, mélamine pierre et bois etc...) **s'adaptent à votre style** et à la **dimension de votre établissement**. La collection **EVENTO** valorise avec une touche de chic la mise en scène de vos buffets, selon le moment de la journée, de la saison...

### KITCHENWARE FOR YOUR BUFFET

From **breakfast to dinner**, from sweet buffets to savoury spreads, the **EVENTO** collection works for all your reception needs. A **unified, harmonious, practical and modular** design. With a **host of combinations** and a **range of materials** to choose from (steel, porcelain, glass, stoneware, melamine, stone and wood...), you can find what **works for your style** and the **size of your space**. The **EVENTO** collection adds a chic touch to your buffet presentations to reflect the time of day or the season.

### CREACIÓN DE UN BUFÉ

La colección **EVENTO** resulta perfecta para cualquier recepción, tanto para bufés dulces como salados, del **desayuno a la cena**. Un diseño **homogéneo, armonioso, funcional y modulable**. La **riqueza de sus combinaciones** y la **diversidad de sus materiales** (acero, porcelana, cristal, gres, melamina de piedra y madera...) **se amoldan a su estilo** y a las **dimensiones de su establecimiento**. La colección **EVENTO** aporta un toque sofisticado para realzar la presentación de sus bufés según el momento del día, de la temporada.

**EVENTO**  
PLATEAUX POUR MODULES FROIDS P.204  
PLATTERS FOR REFRIGERATED UNITS - BANDEJAS PARA LOS MODULOS REFRIGERADOS  
234562 - PLATEAU ROND MÉLAMINE PIERRE P.212  
STONE MELAMINE ROUND TRAY - BANDEJA REDONDA MELAMINA PIEDRA





CHAFING DISHES\*

LE CHAFING DISH, PAR SON DESIGN CONTEMPORAIN ALLIANT ACIER, PORCELAINE ET VERRE OFFRE À VOTRE BUFFET UNE PRÉSENTATION SOIGNÉE ET RAFFINÉE.

THE CHAFING DISH, WITH ITS CONTEMPORARY DESIGN THAT COMBINES STEEL, PORCELAIN AND GLASS, BRINGS A SMART AND SOPHISTICATED TOUCH TO YOUR BUFFET DISPLAY.

EL CHAFING DISH, POR SU DISEÑO CONTEMPORÁNEO QUE COMBINA ACERO, PORCELANA Y CRISTAL OFRECE A SU BUFFET UNA PRESENTACIÓN CUIDADA Y REFINADA.

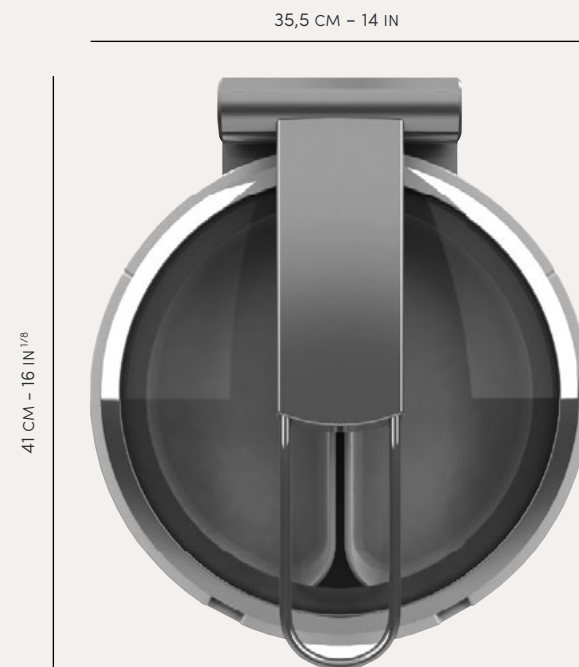

Ø 35,5 CM X P 41 CM X H 15 CM  
Ø 14 IN X D 16 IN<sup>1/8</sup> X H 5 IN<sup>7/8</sup>

Charnière avec vérin et amortisseur pour un réel confort d'utilisation et une fermeture en douceur

The hydraulic buffering hinge offers user comfort and convenience with its soft closure mechanism

La bisagra con amortiguación hidraulica ofrece al usuario comodidad y conveniencia con su mecanismo de cierre suave

Couvercle en verre transparent pour percevoir le contenu et rendre le buffet plus gourmand

Clear glass cover allows contents to be viewed instantly and makes the buffet more enticing

Cubierta de vidrio transparente permite que el contenido pueda ser visto instantáneamente y hace que el buffet más atractivo



Encoches pour les couverts de service

The notch for the serving cutlery

El agua condensada se recoge mediante un sistema de la ranura para las piezas de servicio

Système de récupération d'eau de condensation

Condensation water collection system in the porcelain insert

El agua condensada se recoge mediante un sistema de recolección en la base de porcelana

Compatible plaque induction, avec résistance électrique ou porte-brûleur avec gel combustible

Compatible with induction, electrical and/or «sterno» fuel heating system

Compatible con induccion, eléctrico o sistema de color externo

\*CERTAINES PIÈCES SONT DISPONIBLES EN PIÈCES DÉTACHÉES  
SOME ITEMS ARE AVAILABLE INDIVIDUALLY  
ALGUNOS DE ESTOS ARTICULOS ESTÁN DISPONIBLES COMO PIEZAS SEPARADAS





236195 **NEW**

**CHAFING DISH SANS BAC FINITION MIROIR**

CHAFING DISH WITHOUT INSERT MIRROR FINISH  
CHAFING DISH SIN BANDEJA ACABADO BRILLO  
Ø 35,5 CM - P 41 CM - H 15 CM  
Ø 14 IN - D 16 IN<sup>7/8</sup> - H 5 IN<sup>7/8</sup>

**Acier inoxydable, couvercle avec gouttière, verre trempé**  
Stainless steel, lid with groove, tempered glass  
Acero inoxidable, tapa con canalón vidrio templado



216143 **CHAFING DISH BAC ACIER INCLUS FINITION MIROIR**  
CHAFING DISH INSERT MIRROR FINISH  
CHAFING DISH CON BANDEJA ACABADO BRILLO



215722 **CHAFING DISH BAC PORCELAINE INCLUS FINITION MIROIR**  
CHAFING DISH MIRROR FINISH PORCELAIN INSERT INCLUDED  
CHAFING DISH CON BANDEJA ACABADO BRILLO - PORCELANA

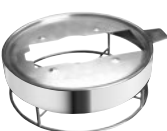

203005 **FINITION MIROIR**  
MIRROR FINISH  
ACABADO BRILLO

236194 **NEW**

**CHAFING DISH SANS BAC FINITION BROSSÉE**

CHAFING DISH WITHOUT INSERT BRUSHED FINISH  
CHAFING DISH SIN BANDEJA ACABADO SATINADO  
Ø 35,5 CM - P 41 CM - H 15 CM  
Ø 14 IN - D 16 IN<sup>7/8</sup> - H 5 IN<sup>7/8</sup>

**Acier inoxydable, couvercle avec gouttière, verre trempé**  
Stainless steel, lid with groove, tempered glass  
Acero inoxidable, tapa con canalón vidrio templado



216144 **CHAFING DISH BAC ACIER INCLUS FINITION BROSSÉE**  
CHAFING DISH INSERT BRUSHED FINISH  
CHAFING DISH SIN BANDEJA ACABADO SATINADO



215723 **CHAFING DISH BAC PORCELAINE INCLUS FINITION BROSSÉE**  
CHAFING DISH BRUSHED FINISH PORCELAIN INSERT INCLUDED  
CHAFING DISH CON BANDEJA ACABADO SATINADO - PORCELANA



202859 **FINITION BROSSÉE**  
BRUSHED FINISH  
ACABADO SATINADO



203470 **COUVERCLE AVEC GOUTTIÈRE ACIER, VERRE TREMPÉ**  
LID WITH STAINLESS STEEL GUTTER, TEMPERED GLASS  
TAPA EN ACERO INOX Y VIDRIO TEMPLADO  
Ø 33 CM - 13 IN



202635 **1/2 BAC PORCELAINE POUR CHAFING DISH**  
1/2 CHAFING PORCELAIN INSERT PARA CHAFING  
L 29 X L15 X H 4,5 CM  
CONTENANCE 1L  
11 IN<sup>7/8</sup> X 5 IN<sup>7/8</sup> X 1 IN<sup>3/4</sup>  
CAPACITY 33 OZ<sup>15/16</sup>



215721 **BAC PORCELAINE POUR CHAFING DISH**  
CHAFING PORCELAIN INSERT BANDEJA DE PORCELANA PARA CHAFING  
Ø 35,6 X H 7 CM  
CONTENANCE 3L  
Ø 14 X 2 IN<sup>3/4</sup>  
CAPACITY 100 OZ



216142 **BAC ACIER POUR CHAFING DISH**  
CHAFING STAINLESS STEEL INSERT BANDEJA DE ACERO INOXIDABLE PARA CHAFING  
Ø 35,6 X H 7 CM  
CONTENANCE 3L  
Ø 14 X 2 IN<sup>3/4</sup>  
CAPACITY 100 OZ



202860 **RÉSISTANCE AVEC RÉGULATEUR DE TEMPÉRATURE**  
HEATING ELEMENT - HEAT ADJUSTABLE RESISTENCIA CON REGULADOR DE TEMPERA  
202860 - 220 /240 V  
203468 - 110 /120 V  
20 X 20 CM  
7 IN<sup>7/8</sup> X 7 IN<sup>7/8</sup>



202861 **PORTE-BRÛLEUR POUR GEL COMBUSTIBLE ACIER**  
BURNER HOLDER STEEL QUEMADOR ACERO INOXIDABLE  
Ø 9 CM - H 6 CM  
Ø 3 IN<sup>9/16</sup> X 2 IN<sup>1/8</sup>





MODULES FROIDS\*

REFRIGERATED UNITS - MODULOS REFRIGERADOS

LE MODULE RÉFRIGÉRÉ REÇOIT UNE LARGE GAMME DE CONTENANTS, PLATEAUX ET ACCESSOIRES MULTI-MATÉRIAUX AU FORMAT GN EN PORCELAINE, VERRE, ACIER, BAMBOU, ACRYLIQUE, MÉLAMINE PIERRE ET MÉLAMINE BOIS. ILS PERMETTENT UNE INFINITÉ DE COMBINAISONS.

THE REFRIGERATED UNIT WILL HOLD A WIDE RANGE OF PLATTERS AND MULTI-MATERIAL ACCESSORIES IN INDUSTRY STANDARD FORMAT IN PORCELAIN, GLASS, STEEL, BAMBOO, ACRYLIC STONE AND WOOD MELAMINE ALLOWING ENDLESS COMBINATIONS.

EL MÓDULO REFRIGERADO PRESENTA UNA AMPLIA VARIEDAD DE BANDEJAS Y ACCESORIOS DE MÚLTIPLES MATERIALES EN FORMATO GN EN PORCELANA, VIDRIO, ACERO, BAMBÚ, ACRÍLICO, MELAMINA DE PIEDRA Y MELAMINA MADERA QUE PERMITEN UN NÚMERO INFINITO DE COMBINACIONES.



**202864**  
**FINITION MIROIR**  
STAINLESS STEEL MIRROR  
ACABADO BRILLO

**202865**  
**FINITION BROSSÉE**  
STAINLESS STEEL BRUSHED  
ACABADO SATINADO

**202869**  
**NOIR MÉTALLISÉ**  
METALLIC BLACK  
ACABADO NEGRO METALICO

**202866**  
**BAC PLASTIQUE**  
PLASTIC TRAY  
BANDEJA

**235356**  
**FINITION MIROIR**  
STAINLESS STEEL MIRROR  
ACABADO BRILLO

**235361**  
**FINITION BROSSÉE**  
STAINLESS STEEL BRUSHED  
ACABADO SATINADO

**235362**  
**NOIR MÉTALLISÉ**  
METALLIC BLACK  
ACABADO NEGRO METALICO

(1) GARANTIE LAVE-VAISSELLE / DISH WASHER SAFE / GARANTIA LAVA-VAJILLAS  
\* CERTAINES PIÈCES SONT DISPONIBLES EN PIÈCES DÉTACHÉES / SOME ITEMS ARE AVAILABLE INDIVIDUALLY / ALGUNOS DE ESTOS ARTICULOS ESTÁN DISPONIBLES COMO PIEZAS SEPARADAS

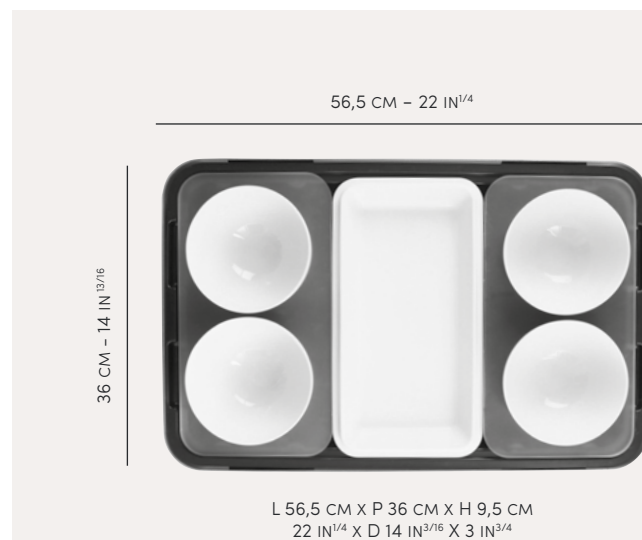

**202871**  
**COUVERCLE MODULE RÉFRIGÉRÉ POIGNÉE INOXYDABLE**  
LID FOR REFRIGERATED SET/  
STAINLESS STEEL HANDLE  
CUBIERTA PARA EL MÓDULO REFRIGERADO/ASA ACERO INOXIDABLE  
56 X 35 X 19 CM  
22 IN 1/16 X 13 IN 3/4 X 7 IN 1/2

**208357**  
**PLAQUE EUTECTIQUE POUR MODULE FROID GN1/1**  
BLACK COOLING EUTECTIQUE BLOCK FOR UNIT GN1/1  
NEGRO ACUMULADOR DE REFRIGERACION 1/1  
48 X 28 X 3 CM  
18 IN 7/8 X 11 IN X 1 IN 3/16

**234568**  
**PLAQUE EUTECTIQUE POUR MODULE FROID GN1/2**  
BLACK COOLING EUTECTIQUE BLOCK FOR UNIT GN1/2  
NEGRO ACUMULADOR DE REFRIGERACION 1/2  
18 X 25 CM  
7 IN 10/16 X 9 IN 13/16





PLATEAUX POUR MODULES FROIDS

PLATTERS FOR REFRIGERATED UNITS  
BANDEJAS PARA LOS MODULOS REFRIGERADOS

	GN 1/1 53,5 X 32,5 CM 20 IN 7/8 X 12 IN 13/16	GN 2/3 35,4 X 32,5 CM 13 IN 15/16 X 12 IN 13/16	GN 1/2 26,4 X 32,5 CM 10 IN 3/8 X 12 IN 13/16	GN 1/3 17,5 X 32,5 CM 6 IN 7/8 X 12 IN 13/16	GN 1/6 8,7 X 32,5 CM 3 IN 7/16 X 12 IN 13/16
<b>PLATEAU GRÈS CARBONÉ<sup>(2)</sup></b> GRES STONEWARE TRAY BANDEJA GRES TONO CARBONO		<b>NEW</b> 		<b>NEW</b> <b>NEW</b> 	
234550 - GN2/3 234555 - GN1/3					
<b>PLAT CREUX GRÈS CARBONÉ<sup>(2)</sup></b> GRES STONEWARE DEEP DISH BANDEJA GRES TONO CARBONO					
234556 - GN1/3					
<b>PLATEAU PORCELAINE</b> WHITE ENAMELLED PORCELAIN TRAY BANDEJA PORCELANA					
202628 - GN2/3 202629 - GN1/2 202627 - GN1/3					
<b>PLAT CREUX PORCELAINE</b> WHITE ENAMELLED PORCELAIN DEEP DISH BANDEJA PORCELANA					
202630 - GN1/3					
<b>PLATEAU BAMBOU ÉPAISSEUR 1,5 CM</b> OILED BAMBOO TRAY THICKNESS 3/16 BANDEJA BAMBOU GROSOR 1,5 CM					
202919 - GN1/1 202920 - GN2/3					
<b>PLATEAU MÉLAMINE BOIS<sup>(3)</sup></b> WOOD MELAMINE TRAY BANDEJA MELAMINA MADERA	<b>NEW</b> 	<b>NEW</b> 	<b>NEW</b> 	<b>NEW</b> 	<b>NEW</b> 
234546 - GN1/1 234548 - GN2/3 234551 - GN1/2 234553 - GN1/3					
<b>PLATEAU 3 TROUS MÉLAMINE BOIS<sup>(3)</sup></b> WOOD MELAMINE TRAY 3 HOLES BANDEJA MELAMINA MADERA CON 3 HUELLAS					
234557 - GN1/6					
<b>PLATEAU MÉLAMINE PIERRE<sup>(3)</sup></b> STONE MELAMINE TRAY BANDEJA MELAMINA PIEDRA	<b>NEW</b> 	<b>NEW</b> 	<b>NEW</b> 	<b>NEW</b> 	<b>NEW</b> 
234547 - GN1/1 234549 - GN2/3 234552 - GN1/2 234554 - GN1/3					
<b>PLATEAU 3 TROUS MÉLAMINE PIERRE<sup>(3)</sup></b> STONE MELAMINE TRAY 3 HOLES BANDEJA MELAMINA PIEDRA CON 3 HUELLAS					
234558 - GN1/6					
<b>PLATEAU ACIER 18-10</b> <b>NEWPORT FINITION MIROIR</b> SERVING TRAY STAINLESS STEEL 18-10 MIRROR FINISHED BANDEJA RECTANGULAR ACERO 18-10 ACABADO BRILLO					
185021 - GN1/1 185019 - GN1/2					
<b>PLATEAU VERRE ÉPAISSEUR 0,6 CM</b> TEMPERED GLASS TRAY THICKNESS 1/4 BANDEJA CRISTAL GROSOR 0,6 CM					
230752 - GN1/1 230753 - GN2/3					
<b>PLATEAU ACRYLIQUE ÉPAISSEUR 1 CM</b> ACRYLIC TRAY THICKNESS 3/8 BANDEJA ACRÍLICO GROSOR 1 CM					
<b>2 TROUS - 2 HOLES - 2 AGUJEROS</b> 230756 - GN1/1					
<b>1 TROU - 1 HOLE - 1 AGUJERO</b> 230755 - GN1/2 Adapté aux bols 22 cm - Adapted for bowls 8,6 inch - Adaptados a boles de 22 cm					
<b>2 TROUS - 2 HOLES - 2 AGUJEROS</b> 230757 - GN1/3 Adapté aux bols 14 cm - Adapted for bowls 5,5 inch - Adaptados a boles de 14 cm					

(2) GARANTIE LAVE-VAISSELLE  
DISH WASHER SAFE  
GARANTIA LAVA-VAJILLAS

(2) GARANTIE MICRO-ONDES  
MICROWAVE SAFE  
GARANTIA MICRO-ONDAS

(3) COMPATIBLE LAVE-VAISSELLE  
DISH WASHER SAFE  
GARANTIA LAVA-VAJILLAS

(3) NON COMPATIBLE MICRO-ONDES  
DON'T USE WITH MICRO-WAVE  
NO VA EN EL MICRO-ONDAS





**URNES À JUS DE FRUITS\***  
FRUIT JUICE URNS - DISPENSADORES DE ZUMOS

URNE À JUS DE FRUIT DOTÉE D'UN TUBE CENTRAL EN ACIER POUR GLACE PILÉE :  
**PARFAIT MAINTIEN DE LA FRAÎCHEUR**

FRUIT JUICE URN WITH CENTRAL STEEL TUBE TO HOLD CRUSHED ICE,  
**FOR PERFECT FRESHNESS**

DISPENSADOR DE ZUMOS DOTADO CON UN TUBO CENTRAL DE ACERO  
PARA HIELO PICADO **PARA MANTENER LA FRESCURA**

**URNE À JUS DE FRUITS 4L - ACIER 18-10**  
JUICE DISPENSER 135 OZ STAINLESS STEEL  
DISPENSADOR DE ZUMO ACERO

231303  
**MIROIR**  
MIRROR  
ACABADO BRILLO

231304  
**BROSSÉ**  
BRUSHED  
ACABADO SATINADO

202855  
**BOUCHON DE CARAFE SILICONE**  
STOPPER FOR CARAFE - SILICONE  
TAPÓN PARA BOTELLA - SILICONA

Ø 6,5 CM - H 4,2 CM  
Ø 2 IN<sup>5/8</sup> X H 1 IN<sup>5/8</sup>



202639  
**CARAFE À JUS DE FRUIT**  
**VERRE - 1,2 L**  
**CRISTALLIN SOUFLÉ BOUCHE**

JUICE/BEVERAGE CARAFE  
40 OZ<sup>3/16</sup> HAND BLOWN CRYSTALLINE  
BOTELLA PARA ZUMOS  
CRISTAL SOPLADO EN BOCA  
Ø 10,5 CM - H 27,5 CM  
Ø 4 IN<sup>1/8</sup> X H 10 IN<sup>13/16</sup>

202632  
**ÉTIQUETTE PORCELAIN**  
**AVEC AIMANT+ SUPPORT ACIER**

PORCELAIN STICK + STAINLESS STEEL STAND  
WITH MAGNET  
ETIQUETA PORCELANA + SOPORTE ACERO  
INOX CON IMÁN  
10 X 5 CM - 3 IN<sup>5/16</sup> X 1 IN<sup>15/16</sup>



\* CERTAINES PIÈCES SONT DISPONIBLES EN PIÈCES DÉTACHÉES  
SOME ITEMS ARE AVAILABLE INDIVIDUALLY  
ALGUNOS DE ESTOS ARTICULOS ESTÁN DISPONIBLES COMO PIEZAS SEPARADAS

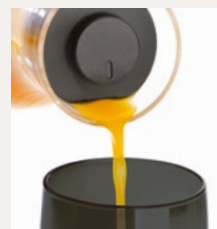

**BOUCHON VERSEUR**  
**EN SILICONE, POUR UNE**  
**MEILLEURE HYGIÈNE**

HYGIENIC SILICONE  
POURING STOPPER

TAPÓN DE SILICONA PARA MAYOR  
HIGIENE Y CONTROL  
DEL VERTIDO

**POSSIBILITÉ D'AIMANTER**  
**L'ÉTIQUETTE PORCELAIN**  
SUR LE COUVERCLE

**MAGNETIC PORCELAIN**  
NAME PLATE ACCESSORY  
FOR LID PLACEMENT

PLACA DE **PORCELANA**  
**MAGNÉTICA** PARA COLOCAR  
LOS NOMBRES





**DISTRIBUTEURS À CÉRÉALES\***  
CEREAL DISPENSERS - DISPENSADORES DE CEREALES

DISTRIBUTEUR À CÉRÉALES 1 OU 3 TUBES  
AVEC AILETTES SOUPLES POUR NE PAS CASSER LES CÉRÉALES

CEREAL DISPENSER 1 OR 3 TUBS WITH  
FLEXIBLE SPOUT SO AS NOT TO BREAK THE CEREALS

DISPENSADOR DE CÉRÉALES 1 O 3 TUBOS CON  
PESTAÑAS FLEXIBLES PARA NO ROMPER LOS CEREALES



50 CM - 19 IN<sup>11/16</sup>

231300 - X3  
L 50 CM X P 20 CM X H 55,5 CM  
W 19 IN<sup>11/16</sup> X D 7 IN<sup>7/8</sup> X H 21 IN<sup>7/8</sup>  
CAPACITÉ : 3 X 3,5 L  
CAPACITY : 3 X 1 GAL

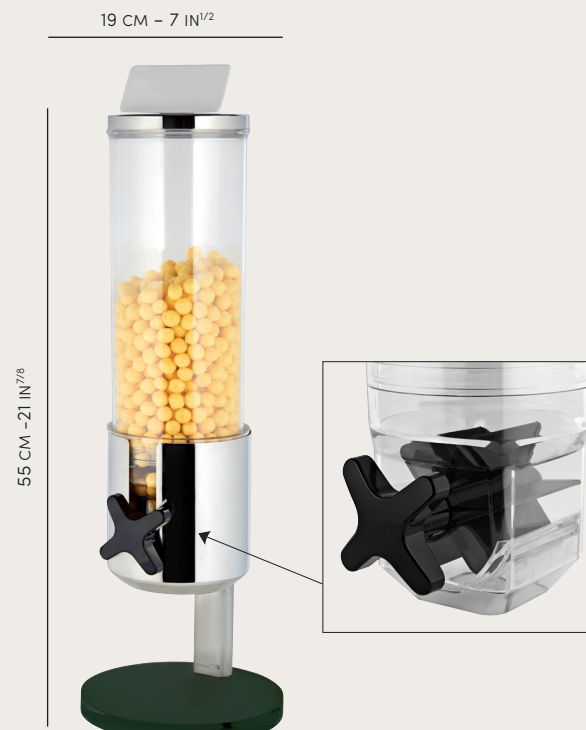

19 CM - 7 IN<sup>1/2</sup>

55 CM - 21 IN<sup>7/8</sup>

231299 - X1  
L 19 CM X P 20 CM X H 55,5 CM  
W 7 IN<sup>1/2</sup> X D 7 IN<sup>7/8</sup> X H 21 IN<sup>7/8</sup>  
CAPACITÉ : 3,5 L  
CAPACITY : 1 GAL

202855  
**BOUCHON DE CARAFE**  
SILICONE

STOPPER FOR CARAFE  
SILICONE  
TAPÓN PARA BOTELLA  
SILICONA  
Ø 6,5 CM - H 4,2 CM  
Ø 2 IN<sup>3/16</sup> X H 1 IN<sup>5/8</sup>



202636  
**CARAFE À LAIT**  
PORCELAIN - 1,2 L

PORCELAIN MILK JUG  
40 OZ<sup>3/16</sup>  
BOTELLA PARA LECHE  
PORCELANA  
Ø 10,5 CM - H 27,5 CM  
Ø 4 IN<sup>1/8</sup> X H 10 IN<sup>13/16</sup>



154245  
**BOL MODULO BLANC**  
WHITE MODULO BOWL  
BOL MODULO BLANCO  
14 CM - 5 IN<sup>1/2</sup>



202626  
**BOL EMPILABLE**  
PORCELAIN STACKABLE BOWL  
BOWL PORCELANA APILABLE  
14 CM - 5 IN<sup>1/2</sup>



\* CERTAINES PIÈCES SONT DISPONIBLES EN PIÈCES DÉTACHÉES  
SOME ITEMS ARE AVAILABLE INDIVIDUALLY  
ALGUNOS DE ESTOS ARTICULOS ESTÁN DISPONIBLES COMO PIEZAS SEPARADAS



**SUPPORTS À FIL RECTANGULAIRES**  
RECTANGULAR TRAYS - SOPORTES RECTANGULARES

DES SUPPORTS EN ACIER NOIR MAT DE HAUTEURS DIFFÉRENTES POUR RYTHMER LES PRÉSENTATIONS

BLACK MAT FINISH SUPPORTS OF DIFFERING HEIGHTS CAN BE USED TO CREATE A VARIED PRESENTATION

SOPORTES DE ACERO NEGRO DE DIFERENTES ALTURAS PARA MARCAR EL RITMO DE LAS PRESENTACIONES

**230741 SUPPORT RECTANGULAIRE NIVEAU 1**

RECTANGULAR TRAY, LEVEL 1  
SOPORTE RECTANGULAR, NIVEL 1  
L 44 X P 30,8 X H 10,8 CM  
W 17 IN<sup>5/8</sup> X D 12 IN<sup>7/8</sup> X H 4 IN<sup>1/4</sup>



**230742 SUPPORT RECTANGULAIRE NIVEAU 2**

RECTANGULAR TRAY, LEVEL 2  
SOPORTE RECTANGULAR, NIVEL 2  
L 42 X P 30,8 X H 29,8 CM  
W 16 IN<sup>5/8</sup> X D 12 IN<sup>7/8</sup> X H 11 IN<sup>3/4</sup>

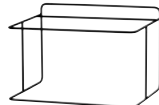

**230741 + 230742 SUPPORT RECTANGULAIRE NIVEAU 1+2**

RECTANGULAR TRAY, LEVEL 1+2  
SOPORTE RECTANGULAR, NIVEL 1+2  
L 44 X P 50 X H 29,8 CM  
W 17 IN<sup>5/8</sup> X D 19 IN<sup>11/16</sup> X H 11 IN<sup>3/4</sup>

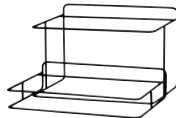

**230743 SUPPORT RECTANGULAIRE NIVEAU 3**

RECTANGULAR TRAY, LEVEL 3  
SOPORTE RECTANGULAR, NIVEL 3  
L 40 X P 30,8 X H 48,8 CM  
W 15 IN<sup>3/4</sup> X D 12 IN<sup>7/8</sup> X H 19 IN<sup>3/16</sup>

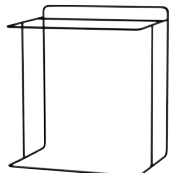

**230742+230743 SUPPORT RECTANGULAIRE NIVEAU 2+3**

RECTANGULAR TRAY, LEVEL 2+3  
SOPORTE RECTANGULAR, NIVEL 2+3  
L 42 X P 50 X H 48,8 CM  
W 16 IN<sup>5/8</sup> X D 19 IN<sup>11/16</sup> X H 19 IN<sup>3/16</sup>

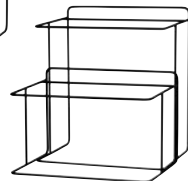

**230741 + 230742+230743 SUPPORT RECTANGULAIRE NIVEAU 1+2+3**

RECTANGULAR TRAY, LEVEL 1+2+3  
SOPORTE RECTANGULAR, NIVEL 1+2+3  
L 44 X P 68,2 X H 48,8 CM  
W 17 IN<sup>5/8</sup> X D 26 IN<sup>7/8</sup> X H 19 IN<sup>3/16</sup>

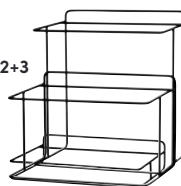

**230744 CADRE ACIER POUR SUPPORT RECTANGULAIRE**

STEEL FRAME FOR STAND  
ESTRUCTURA DE ACERO  
L 55,5 X P 35 X H 4,5 CM  
W 21 IN<sup>7/8</sup> X D 13 IN<sup>3/8</sup> X H 1 IN<sup>3/4</sup>



**230749 PANIERE RECTANGULAIRE - GN 1/1**

RECTANGULAR BREAD BASKET  
CESTA BOLLERIA RECTANGULAR  
54 X 34 X H 7 CM  
21 IN<sup>1/4</sup> X 13 IN<sup>3/8</sup> X 2 IN<sup>3/4</sup>



**PANIÈRE REVERSIBLE POUR UNE PRÉSENTATION DROITE OU INCLINÉE**  
REVERSIBLE BASKET FOR A LEVEL OR TITLED DISPLAY  
PANERA REVERSIBLE PARA UNA PRESENTACION DERECHA O INCLINADA



**185021 - GN1/1 PLATEAU ACIER 18-10 NEWPORT FINITION MIROIR**  
SERVING TRAY STAINLESS STEEL 18-10 MIRROR FINISHED  
BANDEJA RECTANGULAR ACERO 18-10 ACABADO BRILLO



**230752 - GN1/1 PLATEAU VERRE ÉPAISSEUR 0,6 CM**  
TEMPERED GLASS TRAY THICKNESS 1/16  
BANDEJA CRISTAL GROSOR 0,6 CM



**202919 - GN1/1 PLATEAU BAMBOU ÉPAISSEUR 1,5 CM**  
OILED BAMBOO TRAY THICKNESS 1/8  
BANDEJA BAMBOO GROSOR 1,5 CM



**234546 - GN1/1 PLATEAU MÉLAMINE BOIS<sup>(3)</sup>** **NEW**  
WOOD MELAMINE TRAY  
BANDEJA MELAMINA MADERA



**234547 - GN1/1 PLATEAU MÉLAMINE PIERRE<sup>(3)</sup>** **NEW**  
STONE MELAMINE TRAY  
BANDEJA MELAMINA PIEDRA

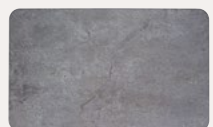

(3) COMPATIBLE LAVE-VAISSELLE  
DISH WASHER SAFE  
GARANTIA LAVA-VAJILLAS

(3) NON COMPATIBLE MICRO-ONDES  
DON'T USE WITH MICRO-WAVE  
NO VA EN EL MICRO-ONDAS





**SUPPORTS À FIL RONDS**  
ROUND TRAYS - RONDOS BANDEJAS

POUR PANIÈRES RONDES, PLATEAUX 32 CM ET SALADIERS 28 CM

STANDS FOR ROUND BASKETS, TRAYS 12 IN<sup>5/8</sup> AND SALAD BOWLS 11 IN

SOPORTES PARA RONDO, BANDEJA, BOL

230745  
**SUPPORT ROND BAS**  
ROUND STAND, LOW LEVEL  
SOPORTE REDONDO BAJO  
Ø 25 CM X H 13 CM  
Ø 9 IN<sup>13/16</sup> X H 5 IN<sup>1/8</sup>

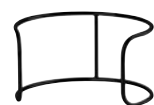

230746  
**SUPPORT ROND HAUT**  
ROUND STAND, HIGH LEVEL  
SOPORTE REDONDO ALTO  
Ø 25 CM X H 26 CM  
Ø 9 IN<sup>13/16</sup> X H 10 IN<sup>1/4</sup>

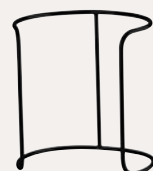

234564  
**SALADIER BAS GRÈS CARBONE<sup>(1)</sup>**  
GREY STONEWARE LOW SALAD BOWL  
ENSALADERA GRÉS TAMANO BAJO  
TONO CARBONO  
Ø 25,4 X 7 CM - 2,4 L  
Ø 10 IN X 2 IN<sup>3/4</sup> - 80 OZ<sup>1/8</sup>



NEW

136524  
**PLATEAU ROND PORCELAINE MODULO**  
PIE/PIZZA PLATE, FLAT  
FUENTE PARA PASTEL  
Ø 32 CM - 12 IN<sup>5/8</sup>



234563  
**SALADIER HAUT GRÈS CARBONE<sup>(1)</sup>**  
GREY STONEWARE HIGH SALAD BOWL  
ENSALADERA GRÉS TAMANO ALTO  
TONO CARBONO  
Ø 25,4 X 13 CM - 5,1 L  
Ø 10 IN X 5 IN<sup>1/8</sup> - 172 OZ<sup>7/16</sup>



NEW

234561  
**PLATEAU ROND MÉLAMINE BOIS<sup>(2)</sup>**  
WOOD MELAMINE  
ROUND TRAY  
BANDEJA REDONDA  
MELAMINA MADERA  
Ø 32 CM - 12 IN<sup>5/8</sup>



NEW

230748  
**PANIÈRE RONDE**  
ROUND BREAD BASKET  
CESTA BOLLERÍA REDONDA  
Ø 32 CM X H 8 CM  
Ø 12 IN<sup>5/8</sup> X H 3 IN<sup>1/8</sup>



234562  
**PLATEAU ROND MÉLAMINE PIERRE<sup>(2)</sup>**  
STONE MELAMINE  
ROUND TRAY  
BANDEJA REDONDA  
MELAMINA PIEDRA  
Ø 32 CM - 12 IN<sup>5/8</sup>



NEW

230750  
**PANIÈRE INDIVIDUELLE**  
INDIVIDUAL BREAD BASKET  
CESTA BOLLERÍA INDIVIDUAL  
Ø 18 CM X H 6 CM  
Ø 7 IN<sup>1/16</sup> X H 2 IN<sup>3/8</sup>



230754  
**PLATEAU ROND VERRE GRIS**  
GREY ROUND TRAY  
TEMPERED GLASS  
BANDEJA CRISTAL  
REDONDA  
Ø 32 CM - 12 IN<sup>5/8</sup>

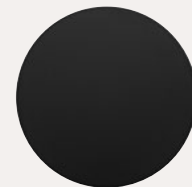

(1) COMPATIBLE LAVE-VAISSELLE  
DISH WASHER SAFE  
GARANTIA LAVA-VAJILLAS

(2) COMPATIBLE LAVE-VAISSELLE  
DISH WASHER SAFE  
GARANTIA LAVA-VAJILLAS

(2) NON COMPATIBLE MICRO-ONDES  
DON'T USE WITH MICRO-WAVE  
NO VA EN EL MICRO-ONDAS





ACCESSOIRES  
ACCESSORIES - ACCESORIOS

230751  
**PANIÈRE À BAGUETTE**  
BAGUETTE BASKET  
CESTA PARA BAGUETTE  
27 CM X H 52 CM  
10 IN<sup>5/8</sup> X H 20 IN<sup>1/2</sup>



234559  
**PLANCHA AVEC MANCHE MÉLAMINE BOIS<sup>(1)</sup>**  
WOOD MELAMINE BOARD  
PLANCHA CON MANGO  
MELAMINA MADERA  
17,5 X 45 CM - 6 IN<sup>7/8</sup> X 17 IN<sup>15/16</sup>



NEW

234560  
**PLANCHA AVEC MANCHE MÉLAMINE PIERRE<sup>(1)</sup>**  
STONE MELAMINE BOARD  
PLANCHA CON MANGO  
MELAMINA PIEDRA  
17,5 X 45 CM - 6 IN<sup>7/8</sup> X 17 IN<sup>15/16</sup>



NEW

202631  
**PRÉSENTOIR DE TABLE EN PORCELAINE**  
PORCELAIN TABLE CENTER PIECE  
PIEZA DE PORCELANA CENTRO DE MESA  
15,5 X 7,5 CM - 6 IN<sup>1/8</sup> X 2 IN<sup>15/16</sup>



202632  
**ETIQUETTE PORCELAINE AVEC AIMANT + SUPPORT ACIER**  
PORCELAIN STICK + STAINLESS STEEL STAND + MAGNET  
ETIQUETA PORCELANA + SOPORTE ACERO INOX CON IMAN  
10 X 5 CM - 3 IN<sup>15/16</sup> X 1 IN<sup>15/16</sup>



202633  
**SUPPORT COUVERTS DE SERVICE PORCELAINE**  
SERVING CUTLERY DISPLAY  
WHITE PORCELAIN  
SOPORTE PARA PIEZAS DE SERVICIO  
PORCELANA BLANCA  
21 X 10 X 5 CM  
8 IN<sup>1/4</sup> X 3 IN<sup>15/16</sup> X 1 IN<sup>15/16</sup>



214185  
**COUPE ACIER**  
STAINLESS STEEL BOWL  
TAZÓN ACERO  
Ø 11,5 CM - Ø 4 IN<sup>1/2</sup>



214182  
**PRÉSENTOIR ACIER MIROIR 3 TROUS**  
THREE HOLES STAINLESS STEEL STAND MIRROR FINISH  
EXPOSITOR DE ACERO EN BRILLO 3 AGUJEROS  
41 X 12,5 X 2,3 CM  
16 IN<sup>1/8</sup> X 4 IN<sup>15/16</sup> X 1 IN<sup>7/16</sup>



204499 184355   
**PINCE À SERVIR**  
SERVING TONG  
PINZAS PARA SERVIR  
29,5 CM - 11 IN<sup>5/8</sup>



204498 101492   
**PINCE À PAIN**  
BREAD TONG  
PINZAS PAN  
23 CM - 9 IN<sup>1/16</sup>



204496 101494   
**CISEAUX À GÂTEAUX**  
PASTRY SCISSORS/TONG  
PINZAS PARA PASTELES  
20 CM - 7 IN<sup>7/8</sup>



130994   
**CUILLÈRE À TOAST**  
APPETIZER SPOON  
CUCHARA APERITIVO  
11,8 CM - 4 IN<sup>5/8</sup>



202854  
**PLANCHE À PAIN BAMBOU AVEC RÉCUPÉRATEUR DE MIETTES (GN 1/1)**  
BAMBOO BREAD BOARD WITH CRUMB TRAY (GN 1/1)  
PANERA BAMBOO CON RECOGEDOR DE MIGAS (GN 1/1)  
53 X 32,5 CM - 20 IN<sup>7/8</sup> X 12 IN<sup>13/16</sup>



229516  
**COUPEAU L'ECONOME BY STARCK® POSITIONNABLE DANS LA PLANCHE**  
ECONOME BY STARCK® BREAD KNIFE FITS IN A SLOT IN THE BREAD BOARD  
CUCHILLO DE PAN ECONOME BY STARCK® SE ENCAJA EN UNA RANURA DE LA PANERA  
24 CM - 9 IN<sup>7/16</sup>



217814  
**COUPEAU L'ECONOME ECO NATURE® POSITIONNABLE DANS LA PLANCHE**  
ECONOME ECO NATURE® BREAD KNIFE FITS IN A SLOT IN THE BREAD BOARD  
CUCHILLO DE PAN ECONOME ECO NATURE® SE ENCAJA EN UNA RANURA DE LA PANERA  
18 CM - 7 IN<sup>1/16</sup>



209381  
**PRÉSENTOIR À GÂTEAUX ROND**  
ROUND APP / PIZZA / PRESENTATION STAND  
EXPOSITOR DE TARTAS  
Ø 25 CM - 9 IN<sup>13/16</sup>



209382  
Ø 32 CM - 12 IN<sup>5/8</sup>



230337  
**BOL EVENTO GRIS PERLE**  
GREY EVENTO BOWL  
BOL EVENTO GRIS  
22 CM - 8 IN<sup>11/16</sup>

202625  
**BOL EVENTO BLANC**  
WHITE EVENTO BOWL  
BOL EVENTO BLANCO  
22 CM - 8 IN<sup>11/16</sup>

142722  
**BOL PORCELAINE MODULO**  
DEEP BOWL, LARGE  
BOL HONDO  
28 CM - 11 IN  
CONTENANCE : 2,5 L  
CAPACITY : 84 OZ<sup>21/16</sup>  
H : 12 CM - 4 IN<sup>3/4</sup>

168845   
**CUILLÈRE À SPAGHETTI**  
SPAGHETTI SERVING SPOON  
CUCHARA PARA ESPAGUETIS  
29 CM - 11 IN<sup>7/16</sup>



168846   
**LOUCHETTE**  
GRAVY LADLE  
CUCHARÓN  
29 CM - 11 IN<sup>7/16</sup>



168844   
**FOURCHETTE À VIANDE**  
MEAT FORK  
TENEDOR DE CARNE  
29 CM - 11 IN<sup>7/16</sup>



168843   
**CUILLÈRE DE SERVICE**  
SERVING SPOON  
CUCHARA DE SERVICIO/ENSALADA  
32 CM - 12 IN<sup>5/8</sup>



130610  
**REPOSE CUILLÈRE PORCELAINE**  
SPOON REST WITH CERAMIC BOWL  
CUCHARA DESCANSA EN PORCELANA  
H 23,5 CM X L 11,5 CM - 9 IN<sup>3/4</sup> X 4 IN<sup>1/2</sup>



153193   
**LOUCHE ASTREE MIROIR**  
SOUP LADLE  
CAZO  
29,7 CM - 11 IN<sup>11/16</sup>



(2) COMPATIBLE LAVÉ-VAISSÈLLE  
DISH WASHER SAFE  
GARRANTIA LAVA-VAJILLAS  
(2) NON COMPATIBLE MICRO-ONDES  
DON'T USE WITH MICRO-WAVE  
NO VA EN EL MICRO-ONDAS









## PIÈCES DÉTACHÉES

AVAILABLE INDIVIDUALLY - PIEZAS SEPARADAS

## CHAFING DISH

203470  
**COUVERCLE AVEC GOUTTIÈRE  
ACIER ET VERRE TREMPÉ**  
LID WITH STAINLESS STEEL GUTTER,  
TEMPERED GLASS  
TAPA EN ACERO INOX  
Y VIDRIO TEMPLADO  
Ø 33 CM - Ø 13 IN

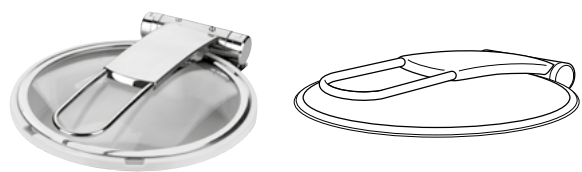

216142  
**BAC ACIER  
POUR CHAFING DISH**  
CHAFING STAINLESS STEEL INSERT  
BANDEJA DE ACERO INOXIDABLE  
PARA CHAFING  
Ø 35,5 X H 6,3 CM  
CONTENANCE - CAPACIDAD 3L  
Ø 14 X 2 IN<sup>1/2</sup>  
CAPACITY 100 OZ



215721  
**BAC PORCELAINE  
POUR CHAFING DISH**  
CHAFING PORCELAIN INSERT  
BANDEJA DE PORCELANA  
PARA CHAFING  
Ø 35,6 X H 6,3 CM  
CONTENANCE - CAPACIDAD 3L  
Ø 14 X 2 IN<sup>1/2</sup>  
CAPACITY 100 OZ



202635  
**1/2 BAC PORCELAINE  
POUR CHAFING DISH**  
1/2 CHAFING PORCELAIN INSERT  
1/2 BANDEJA DE PORCELANA  
PARA CHAFING  
L 29 X L15 X H 4,5 CM  
CONTENANCE - CAPACIDAD 1L  
11 IN<sup>7/16</sup> X 5 IN<sup>7/16</sup> X 1 IN<sup>3/4</sup>  
CAPACITY 33 OZ<sup>15/16</sup>

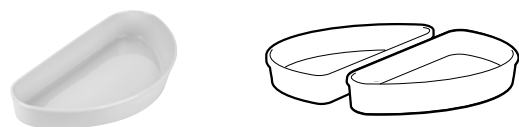

**SUPPORT CHAFING**  
ACIER INOXYDABLE, POUR RÉSISTANCE ÉLECTRIQUE  
OU PORTE-BRÛLEUR AVEC GEL COMBUSTIBLE  
CHAFING STAND STAINLESS STEEL, FOR ELECTRICAL  
AND/OR STERNO HEATING PURPOSES  
SOPORTE PARA CHAFING DISH ACERO INOXIDABLE  
PARA RESISTENCIA ELÉCTRICA O CALENTADOR  
EXTERNO  
Ø 35 CM X P 40 CM X H 12,5 CM  
Ø 13 IN<sup>3/4</sup> X D 15 IN<sup>3/4</sup> X H 4 IN<sup>15/16</sup>

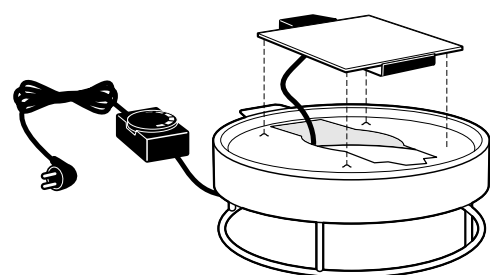

203005  
**FINITION MIROIR**  
MIRROR FINISH  
ACABADO BRILLO



202859  
**FINITION BROSSÉE**  
BRUSHED FINISH  
ACABADO SATINADO

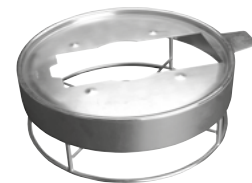

**MODULE FROID**  
REFRIGERATED UNIT - MODULO REFRIGERADOS

202866  
**BAC PLASTIQUE**  
PLASTIC TRAY  
BANDEJA  
56 X 35,5 X 8 CM  
22 IN<sup>1/16</sup> X 14 IN X 3 IN<sup>1/8</sup>



**RÉSISTANCE AVEC  
RÉGULATEUR DE  
TEMPÉRATURE**  
202860 - 220 /240 V  
203468 - 110 /120 V  
HEATING ELEMENT - HEAT  
ADJUSTABLE  
RESISTENCIA CON REGULADOR  
DE TEMPERATURA  
20 X 20 CM  
7 IN<sup>7/8</sup> X 7 IN<sup>7/8</sup>



202861  
**PORTE-BRÛLEUR POUR  
GEL COMBUSTIBLE ACIER**  
BURNER HOLDER STEEL  
QUEMADOR ACERO INOXIDABLE  
Ø 9 CM - H 6 CM  
Ø 3 IN<sup>9/16</sup> X 2 IN<sup>3/8</sup>



**URNE À JUS DE FRUITS**  
FRUIT JUICÉ URN - DISPENSADOR DE ZUMOS

**COUVERCLE URNE ACIER 18-10**  
LID FOR STAINLESS DISPENSER 18-10  
TAPA PARA ACERO DISPENSADOR 18-10  
Ø 17,9 CM - 7 IN<sup>17/16</sup>

202881      202891  
**MIROIR      BROSSÉ**  
MIRROR      BRUSHED  
ACABADO BRILLO      ACABADO SATINADO

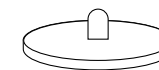

202884  
**TUBE ACIER POUR GLACE**  
ICE TUBE STAINLESS STEEL  
TUBO PARA HIELO ACERO 18-10  
Ø 9 CM - 3 IN<sup>9/16</sup>

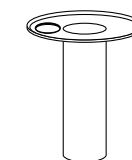

202883  
**FÛT CYLINDRIQUE URNE**  
CONTAINER FOR DISPENSER  
CONTENEDOR PARA EL DISPENSADOR SAN  
5L - 169 OZ<sup>17/16</sup>  
Ø 17,7 CM X H 25,5 CM  
Ø 6 IN<sup>15/16</sup> X H 10 IN<sup>1/16</sup>

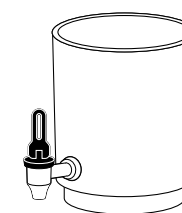

214724  
**ROBINET ACIER**  
STAINLESS STEEL FAUCET  
GRIFO ACERO  
+ ABS NOIR, black, negro



**BASE ACIER 18-10 URNE**  
STAINLESS STEEL STAND FOR DISPENSER 18-10  
SOPORTE ACERO PARA DISPENSADOR 18-10  
Ø 17,6 CM - H 19 CM  
Ø 6 IN<sup>15/16</sup> X H 7 IN<sup>1/2</sup>

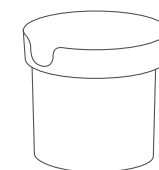

202890      202889  
**MIROIR      BROSSÉ**  
MIRROR      BRUSHED  
ACABADO BRILLO      ACABADO SATINADO

045963  
**GRILLE ACIER POUR GOUTTES**  
STAINLESS STEEL GRID DROP COLLECTOR  
REJILLA DE ACERO PARA RECOGER EL GOTEO  
18-10  
Ø 9 CM - 3 IN<sup>9/16</sup>



230758  
**SOCLE NOIR ACRYLIQUE URNE**  
STAND FOR BLACK DISPENSER  
BASE DEL DISPENSADOR NEGRO  
20 X 32 CM  
7 IN<sup>7/8</sup> X 12 IN<sup>5/8</sup>  
ÉPAISSEUR/ESPESOR : 2 CM  
THICKNESS: 13/16 IN



**DISTRIBUTEUR À CÉRÉALES**  
CEREALES DISPENSER - DISPENSADOR DE CEREALES

213078  
**COUVERCLE DISTRIBUTEUR CEREALES  
ACIER FINITION MIROIR**  
LID FOR CEREAL DISPENSER, STAINLESS STEEL,  
MIRROR FINISH  
TAPA PARA DISPENSADOR EN BRILLO, ACERO  
18-10  
Ø 12,5 CM - Ø 4 IN<sup>15/16</sup>



213076  
**FUT CYLINDRIQUE AVEC AILETTE  
ET POIGNEE DISTRIBUTEUR CEREALES**  
BARREL + HANDLE + ROLLING TAP  
FOR CEREAL DISPENSER  
CONTENEDOR PARA EL DISPENSADOR  
CON ALETA Y ASA  
P 16,1 X H 42 CM - D 6 IN<sup>5/16</sup> X H 16 IN<sup>9/16</sup>



231301  
**BASE + TUBE + SOCLE X1  
DISTRIBUTEUR À CEREALES**  
STAINLESS STEEL STAND + TUB  
+ ACRYLIC STAND FOR CEREAL DISPENSER  
BASE + TUBO + ZÓCALO DISPENSADOR  
DE CEREALES  
L 19 X H 27,5 CM - L 7 IN<sup>1/2</sup> X H 29 IN<sup>3/4</sup>



231302  
**BASE + TUBE + SOCLE X3  
DISTRIBUTEUR À CEREALES**  
STAINLESS STEEL STAND + TUB  
+ ACRYLIC STAND FOR CEREAL DISPENSER  
BASE + TUBO + ZÓCALO  
X3 DISPENSADOR DE CEREALES  
L 50 X H 27,5 CM - L 19 IN<sup>17/16</sup> X H 29 IN<sup>3/4</sup>

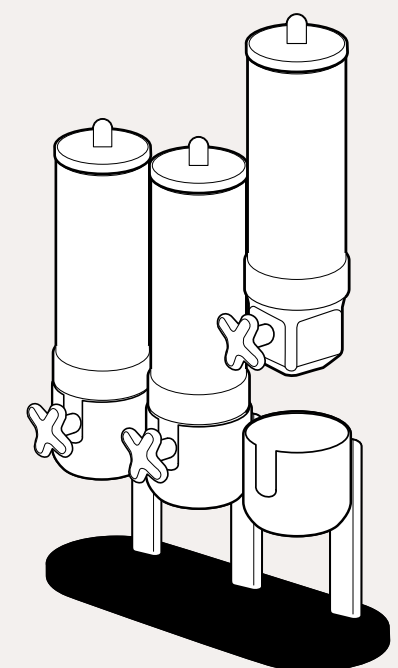





---

## CUISINE

---

Véritable tradition pour DEGRENNE, le culinaire se décline en **ustensiles de cuisson, de préparation, de découpe et d'affutage**, pour inviter les chefs à la réalisation de recettes savoureuses et délicates. Les gammes coutellerie **l'Unique Sabatier** ainsi que les ustensiles de préparation de la célèbre marque **L'Econome®**, sont **gages de qualité** et témoignent d'un véritable esprit précurseur dans l'histoire de la cuisine française. Experte dans le travail de l'acier et notamment sur l'embouti, DEGRENNE présente également **Newcook Expert, une gamme d'ustensiles de cuisson 100% fabriquée en France**. En alliant **précision, technologie** Multiply et **design**, Newcook Expert promet des moments de création uniques.

---

## KITCHENWARE

---

Kitchenware is a real tradition at DEGRENNE and our range comprises **cooking, preparation, slicing and sharpening utensils** to encourage chefs to make flavoursome and delicate dishes. The **Unique Sabatier** cutlery ranges and the famous **L'Econome®** brand's food preparation utensils, are a **guarantee of quality** and bear witness to a trailblazing spirit in the history of French cuisine. DEGRENNE has steel-working and specifically metal stamping expertise, and is also presenting **Newcook Expert, a range of cooking utensils entirely made in France**. Newcook Expert promises unique creative moments, as the range combines **precision, Multiply technology** and **great design**.

---

## COCINA

---

Verdadera tradición para DEGRENNE, lo culinario se declina en **utensilios de cocción, de preparación, de corte y de afilado**, para invitar a los chefs a la preparación de recetas sabrosas y delicadas. Las gamas de cuchillería, **Unique Sabatier**, así como los utensilios de preparación de la famosa marca, **L'Econome®**, son garantía de calidad y dan fe de un verdadero espíritu pionero en la historia de la cocina francesa. Experta en el trabajo del acero, sobre todo en el estampado, DEGRENNE también presenta **Newcook Expert, una gama de utensilios de cocina, 100 % fabricada en Francia**. Aliando **precisión, tecnología** Multiply y **diseño**, Newcook Expert promete momentos de creación únicos.

NEWCOOK EXPERT  
223992 - COUVERCLE - LID - TAPA - 28 CM - 11 IN

P.226



**COUPEAU OFFICE**  
PARING KNIFE  
CUCHILLO MONDADOR  
8 CM - 3 IN<sup>17/16</sup>  
218590 IDÉAL FORGÉ



**COUPEAU OFFICE**  
PARING KNIFE  
CUCHILLO MONDADOR  
10 CM - 4 IN  
218587 IDÉAL FORGÉ  
218591 IDÉAL FORGÉ OLIVIER



**COUPEAU OFFICE BEC OISEAU**  
CURVED BLADE PARING KNIFE  
CUCHILLON MONDADOR PICO DE PAJARO  
8 CM - 3 IN<sup>17/16</sup>  
218585 IDÉAL FORGÉ



**COUPEAU DE CUISINE**  
CHEF'S KNIFE  
CUCHILLO DE COCINA  
15 CM - 6 IN  
218593 IDÉAL FORGÉ  
218595 IDÉAL FORGÉ OLIVIER



**COUPEAU DE CUISINE**  
CHEF'S KNIFE  
CUCHILLO DE COCINA  
20 CM - 8 IN  
218596 IDÉAL FORGÉ  
218599 IDÉAL FORGÉ OLIVIER



**COUPEAU DE CUISINE**  
CHEF'S KNIFE  
CUCHILLO DE COCINA  
25 CM - 10 IN  
218600 IDÉAL FORGÉ  
218602 IDÉAL FORGÉ OLIVIER



**COUPEAU TRANCELARD**  
SLICING KNIFE  
CUCHILLO PARA CORTAR  
15 CM - 6 IN  
218609 IDÉAL FORGÉ  
218612 IDÉAL FORGÉ OLIVIER



**COUPEAU TRANCELARD**  
SLICING KNIFE  
CUCHILLO PARA CORTAR  
20 CM - 8 IN  
218613 IDÉAL FORGÉ



**COUPEAU TRANCELARD**  
SLICING KNIFE  
CUCHILLO PARA CORTAR  
25 CM - 10 IN  
218616 IDÉAL FORGÉ



**COUPEAU SANTOKU**  
SANTOKU KNIFE GRANTON EDGE  
CUCHILLO SANTOKU  
18 CM - 7 IN<sup>17/16</sup>  
218629 IDÉAL FORGÉ  
218630 IDÉAL FORGÉ OLIVIER



**COUPEAU FILET DE SOLE**  
FILETING KNIFE  
CUCHILLO PARA FILETAR  
15 CM - 6 IN  
218611 IDÉAL FORGÉ

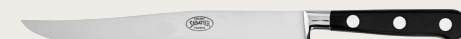
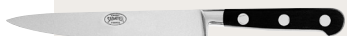

**COUPEAU À JAMBON ALVÉOLÉ**  
HAM SLICER HOLLOW EDGE  
CUCHILLO JAMONERO ALVEOLADO  
30 CM - 12 IN  
218583 IDÉAL FORGÉ

**COUPEAU À DÉOSSER**  
BONING KNIFE  
CUCHILLO DESHUESADOR  
13 CM - 5 IN  
218626 IDÉAL FORGÉ

**COUPEAU À DÉOSSER**  
BONING KNIFE  
CUCHILLO DESHUESADOR  
15 CM - 6 IN  
218628 IDÉAL FORGÉ

**FUSIL À AIGUISER-ABS**  
SHARPENING STEEL-ABS  
AFLADOR-ABS  
30 CM - 12 IN  
217879 AFFUTAGE COUTELLERIE

**FUSIL À AIGUISER**  
SHARPENING STEEL  
AFLADOR  
25 CM - 10 IN  
217880 IDÉAL FORGÉ

**FUSIL À AIGUISER**  
SHARPENING STEEL  
AFLADOR  
20 CM - 8 IN  
217883 IDÉAL FORGÉ OLIVIER

**COUPEAU À DÉCOUPER YATAGAN**  
YATAGAN CARVING KNIFE  
CUCHILLO DE TRINCHAR YATAGAN  
20 CM - 8 IN  
218623 IDÉAL FORGÉ  
218625 IDÉAL FORGÉ OLIVIER

**FOURCHETTE À VIANDE**  
MEAT FORK  
TENEDOR DE CARNE  
17 CM - 6 IN<sup>17/16</sup>  
217868 IDÉAL FORGÉ  
217872 IDÉAL FORGÉ OLIVIER

**COUPEAU À STEAK**  
STEAK KNIFE  
CUCHILLO CHULETERO  
13 CM - 5 IN  
218579 IDÉAL FORGÉ

**COUPEAU À PAIN**  
BREAD KNIFE  
CUCHILLO DE PAN  
20 CM - 8 IN  
218619 IDÉAL FORGÉ  
218622 IDÉAL FORGÉ OLIVIER





**L'ÉCONOME® ECO NATURE**  
NATURAL HUE - TINTE NATURAL



**L'ÉCONOME** **NEW**  
BY STARCK®

217523  
**ÉCONOME**  
PEALER  
PELADOR  
10 CM - 4 IN

217687  
**COUTEAU OFFICE POINTU**  
PARING KNIFE  
CUCHILLO MONDADOR  
9 CM - 3 IN <sup>15/16</sup>

226270  
**COUTEAU OFFICE BEC OISEAU**  
CURVED BLADE PARING KNIFE  
CUCHILLON MONDADOR PICO DE PAJARO  
6,5 CM - 2 IN <sup>5/8</sup>

217804  
**COUTEAU À DÉCOUPER**  
CARVING KNIFE  
CUCHILLO DE TRINCHAR  
20 CM - 8 IN

217806  
**COUTEAU DE CUISINE**  
CHEF'S KNIFE  
CUCHILLO DE COCINA  
15 CM - 6 IN

217808  
**COUTEAU DE CUISINE**  
CHEF'S KNIFE  
CUCHILLO DE COCINA  
20 CM - 8 IN

217814  
**COUTEAU À PAIN**  
BREAD KNIFE  
CUCHILLO DE PAN  
18 CM - 7 IN <sup>7/8</sup>

229514  
**PACK 4 PIECES - ÉCONOME /  
COUTEAU BEC OISEAU /  
FLEXICONOME / COUTEAU OFFICE**  
PACK 4 PIEZAS SET - PEELER/  
CURVED BLADE PARING KNIFE/FLEXICONOME/  
PARING KNIFE  
PAQUETE DE 4 PIEZAS - ÉCONOME/BECK  
CUCHILLOS /FLEXICONOME/CUCHILLO  
MONDADOR

229515  
**COUTEAU DE CUISINE**  
CHEF'S KNIFE  
CUCHILLO DE COCINA  
14 CM - 5 IN <sup>1/2</sup>

229516  
**COUTEAU À PAIN**  
BREAD KNIFE  
CUCHILLO DE COCINA  
24 CM - 9 IN <sup>7/8</sup>

**L'ÉCONOME® BOIS LAQUÉ**  
GLOSS FINISH WOOD - MADERA LACADA

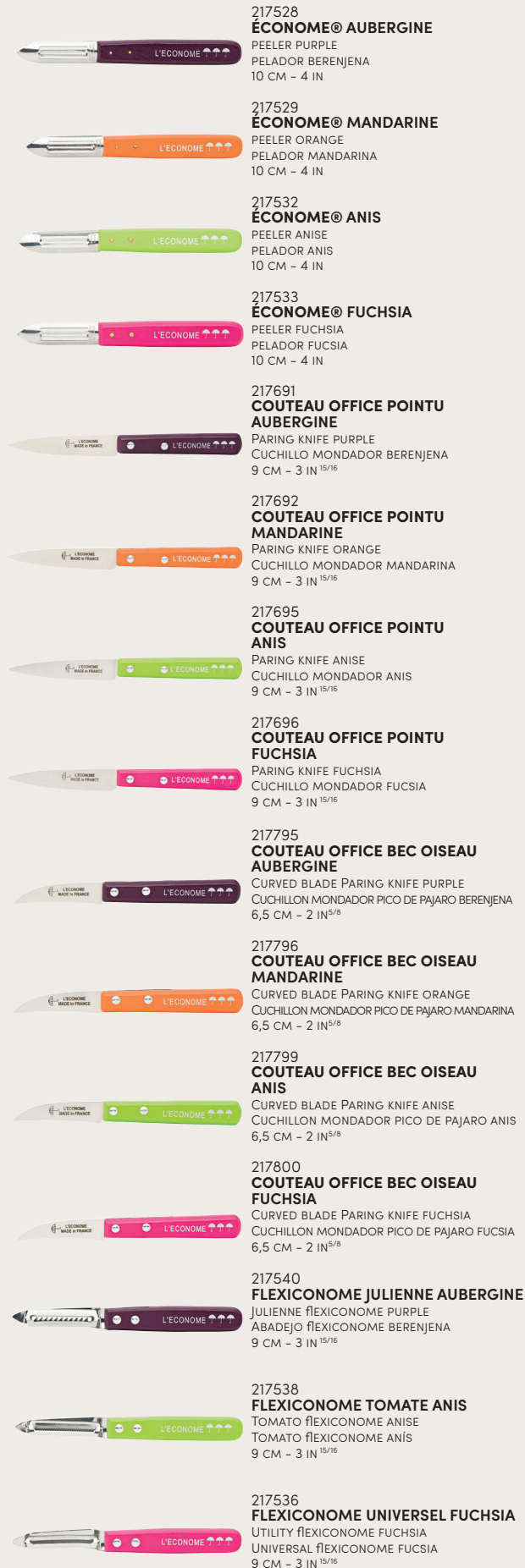

217528  
**ÉCONOME® AUBERGINE**  
PEELER PURPLE  
PELADOR BERENJENA  
10 CM - 4 IN

217529  
**ÉCONOME® MANDARINE**  
PEELER ORANGE  
PELADOR MANDARINA  
10 CM - 4 IN

217532  
**ÉCONOME® ANIS**  
PEELER ANISE  
PELADOR ANIS  
10 CM - 4 IN

217533  
**ÉCONOME® FUCHSIA**  
PEELER FUCHSIA  
PELADOR FUCSIA  
10 CM - 4 IN

217691  
**COUTEAU OFFICE POINTU  
AUBERGINE**  
PARING KNIFE PURPLE  
CUCHILLO MONDADOR BERENJENA  
9 CM - 3 IN <sup>15/16</sup>

217692  
**COUTEAU OFFICE POINTU  
MANDARINE**  
PARING KNIFE ORANGE  
CUCHILLO MONDADOR MANDARINA  
9 CM - 3 IN <sup>15/16</sup>

217695  
**COUTEAU OFFICE POINTU  
ANIS**  
PARING KNIFE ANISE  
CUCHILLO MONDADOR ANIS  
9 CM - 3 IN <sup>15/16</sup>

217696  
**COUTEAU OFFICE POINTU  
FUCHSIA**  
PARING KNIFE FUCHSIA  
CUCHILLO MONDADOR FUCSIA  
9 CM - 3 IN <sup>15/16</sup>

217795  
**COUTEAU OFFICE BEC OISEAU  
AUBERGINE**  
CURVED BLADE PARING KNIFE PURPLE  
CUCHILLON MONDADOR PICO DE PAJARO BERENJENA  
6,5 CM - 2 IN <sup>5/8</sup>

217796  
**COUTEAU OFFICE BEC OISEAU  
MANDARINE**  
CURVED BLADE PARING KNIFE ORANGE  
CUCHILLON MONDADOR PICO DE PAJARO MANDARINA  
6,5 CM - 2 IN <sup>5/8</sup>

217799  
**COUTEAU OFFICE BEC OISEAU  
ANIS**  
CURVED BLADE PARING KNIFE ANISE  
CUCHILLON MONDADOR PICO DE PAJARO ANIS  
6,5 CM - 2 IN <sup>5/8</sup>

217800  
**COUTEAU OFFICE BEC OISEAU  
FUCHSIA**  
CURVED BLADE PARING KNIFE FUCHSIA  
CUCHILLON MONDADOR PICO DE PAJARO FUCSIA  
6,5 CM - 2 IN <sup>5/8</sup>

217540  
**FLEXICONOME JULIENNE AUBERGINE**  
JULIENNE FLEXICONOME PURPLE  
ABADEJO FLEXICONOME BERENJENA  
9 CM - 3 IN <sup>15/16</sup>

217538  
**FLEXICONOME TOMATE ANIS**  
TOMATO FLEXICONOME ANISE  
TOMATO FLEXICONOME ANIS  
9 CM - 3 IN <sup>15/16</sup>

217536  
**FLEXICONOME UNIVERSEL FUCHSIA**  
UTILITY FLEXICONOME FUCHSIA  
UNIVERSAL FLEXICONOME FUCSIA  
9 CM - 3 IN <sup>15/16</sup>

L'ÉCONOME®



© MIMAGES

LA CUISINE  
KITCHENWARE - COCINA



## CASSEROLES SAUCEPAN - CAZO



223972  
**CASSEROLE**  
SAUCEPAN  
CAZO  
14 CM - 5 IN<sup>1/2</sup>

223973  
**CASSEROLE**  
SAUCEPAN  
CAZO  
16 CM - 6 IN<sup>5/16</sup>

223974  
**CASSEROLE**  
SAUCEPAN  
CAZO  
18 CM - 7 IN<sup>7/16</sup>

223975  
**CASSEROLE**  
SAUCEPAN  
CAZO  
20 CM - 7 IN<sup>7/8</sup>

223993  
**ENSEMBLE DE  
3 CASSEROLES**  
SET OF 3 SAUCEPAN  
SET DE 3 CAZOS  
16/18/20 CM  
6 IN<sup>5/16</sup> TO 7 IN<sup>7/8</sup>

## POÊLES FRYING PAN - SARTÉN



223977  
**POÊLE**  
FRYING PAN  
SARTÉN  
24 CM - 9 IN<sup>7/16</sup>

223979  
**POÊLE**  
FRYING PAN  
SARTÉN  
28 CM - 11 IN



223980  
**POÊLE  
ANTI-ADHÉRENTE**  
NON STICK SAUCEPAN  
SARTÉN ANTIADHERENTE  
24 CM - 9 IN<sup>7/16</sup>

223981  
**POÊLE  
ANTI-ADHÉRENTE**  
NON STICK SAUCEPAN  
SARTÉN ANTIADHERENTE  
28 CM - 11 IN

## SAUTEUSES SAUCEPAN - SARTÉN PARA SALTEAR



223983  
**POÊLE  
ANTI-ADHÉRENTE**  
NON STICK SAUCEPAN  
SARTÉN PARA SALTEAR  
24 CM - 9 IN<sup>7/16</sup>

223984  
**SAUTEUSE  
ANTI-ADHÉRENTE**  
NON STICK SAUCEPAN  
SARTÉN PARA SALTEAR  
28 CM - 11 IN

## COCOTTE FRENCH OVEN - OLLA



223986  
**COCOTTE OVALE  
AVEC COUVERCLE**  
OVAL FRENCH OVEN WITH LID  
OLLA OVALADA CON TAPA  
24 X 30 CM - 11 IN<sup>13/16</sup> X 9 IN<sup>7/16</sup>

## FAITOUT STEWOPOT - OLLA



223985  
**FAITOUT**  
STEWOPOT  
OLLA  
24 CM - 9 IN<sup>7/16</sup>

## COUVERCLES LIDS - TAPAS



223987  
14 CM - 5 IN<sup>1/2</sup>

223988  
16 CM - 6 IN<sup>5/16</sup>

223989  
18 CM - 7 IN<sup>1/16</sup>

223990  
20 CM - 7 IN<sup>7/8</sup>

223991  
24 CM - 9 IN<sup>7/16</sup>

223992  
28 CM - 11 IN

CONDUCTION HOMOGENE ET OPTIMALE DE LA CHALEUR DU FOND JUSQU'EN HAUT DES PAROIS POUR UNE PARFAITE MAÎTRISE DE LA TEMPÉRATURE DE CUISSON

CORPS EXTÉRIEUR EN FINITION INOX ET INTÉRIEUR BROSSÉ

GRADUATION INTÉRIEURE DES LITRAGES

PERFORMANCES PROCHES DES QUALITÉS DE CUISSON OBTENUES AVEC DES USTENSILES EN CUIVRE OU EN FONTE

COMPATIBLE TOUS FEUX DONT INDUCTION

ACIER INOXYDABLE  
STAINLESS STEEL  
ACERO INOXIDABLE

ALUMINIUM  
ALUMINIUM  
ALUMINIO

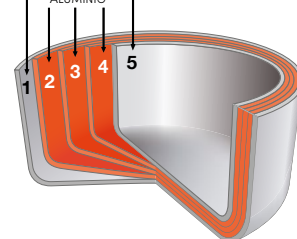

UNIFORM AND OPTIMAL HEAT CONDUCTION FROM THE BASE OF THE PAN TO THE TOP OF THE SIDES FOR A PERFECT CONTROL OF THE COOKING TEMPERATURE

OUTER BODY IN STAINLESS STEEL FINISH AND INSIDE IN BRUSHED STAINLESS STEEL

INTERNAL LITRE SCALE

THE PERFORMANCE IS CLOSE TO COOKING QUALITIES USUALLY OBTAINED FROM COOKING WITH COPPER OR CAST IRON COOKWARE

SUITABLE FOR ALL HOB TYPES INCLUDING INDUCTION

CONDUCCIÓN HOMOGENEA Y ÓPTIMA DEL CALOR DEL FONDO HASTA ARRIBA DE LAS PAREDES PARA UN PERFECTO CONTROL DE LA TEMPERATURA DE COCCIÓN

CUERPO EXTERIOR EN ACABADO DE ACERO INOXIDABLE E INTERIOR EN MATE

GRADUACIÓN INTERIOR DE LOS LITROS

RENDIMIENTOS CERCANOS A LAS CALIDADES DE COCCIÓN OBTENIDAS CON UTENSILIOS DE COBRE O HIERRO FUNDIDO

COMPATIBLE CON TODO TIPO DE FUEGOS, INCLUIDOS LO DE INDUCCIÓN





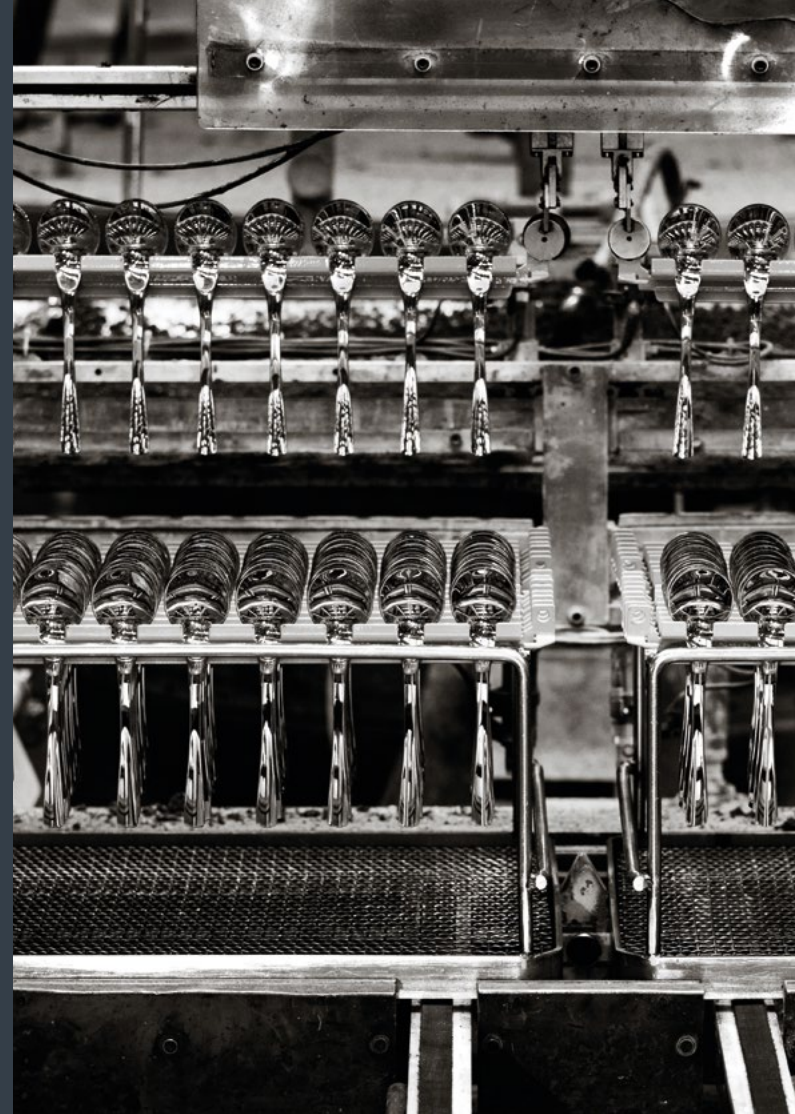

---

## SERVICE DE RÉASSORT



**D**EGRENNE s'engage à vos côtés en vous offrant la possibilité d'effectuer **une commande de réassort pendant les 3 années qui suivent l'arrêt de commercialisation de nos couverts**. Ce service s'applique aux collections identifiées dans ce catalogue par ce pictogramme. Dans le cadre de ce service, **vous avez la possibilité de commander les pièces qui vous manquent, une fois par an et selon les conditions définies** : contactez nos équipes commerciales pour toute demande. Le service de réassort est valable pour les pièces suivantes : Fourchette de table – Cuillère de table – Couteau de table (excepté couteaux lourds) Fourchette à poisson – Couteau à poisson – Fourchette à dessert – Cuillère à dessert – Couteau à dessert (excepté couteaux lourds) – Cuillère à café – Cuillère à moka.

---

## REPLACEMENT PRODUCT SERVICE



DEGRENNÉ enables you to **order replacement products for a further three years after cutlery is discontinued**. This service applies to the collections bearing the logo in the catalogue. This service enables you to **order any items you need once a year and in accordance with the following terms and conditions**: please contact our sales teams if you need to order any products. The replacement products service is available for the following products: table forks, tablespoons, table knives (excluded heavy knives), tea spoons and moka spoons.

---

## SERVICIOS



DEGRENNÉ se compromete a ofrecerle la **posibilidad de efectuar un pedido de renovación de existencias durante los 3 años siguientes al final de la comercialización de nuestros cubiertos**. Ese servicio se aplica a las colecciones identificadas en este catálogo con el pictograma. En el marco de ese servicio, **tiene la posibilidad de pedir las piezas que le falten, una vez al año y según las condiciones definidas**: póngase en contacto con nuestros equipos comerciales para cualquier solicitud. El servicio de renovación de existencias es válido para las siguientes piezas : Tenedor de mesa – Cuchara de mesa – Cuchillo de mesa (salvo cuchillos pesados) – Tenedor de pescado – Cuchillo de pescado – Tenedor de postre – Cuchara de postre – Cuchillo de postre (salvo cuchillos pesados) – Cucharilla de café – Cucharilla de moka.





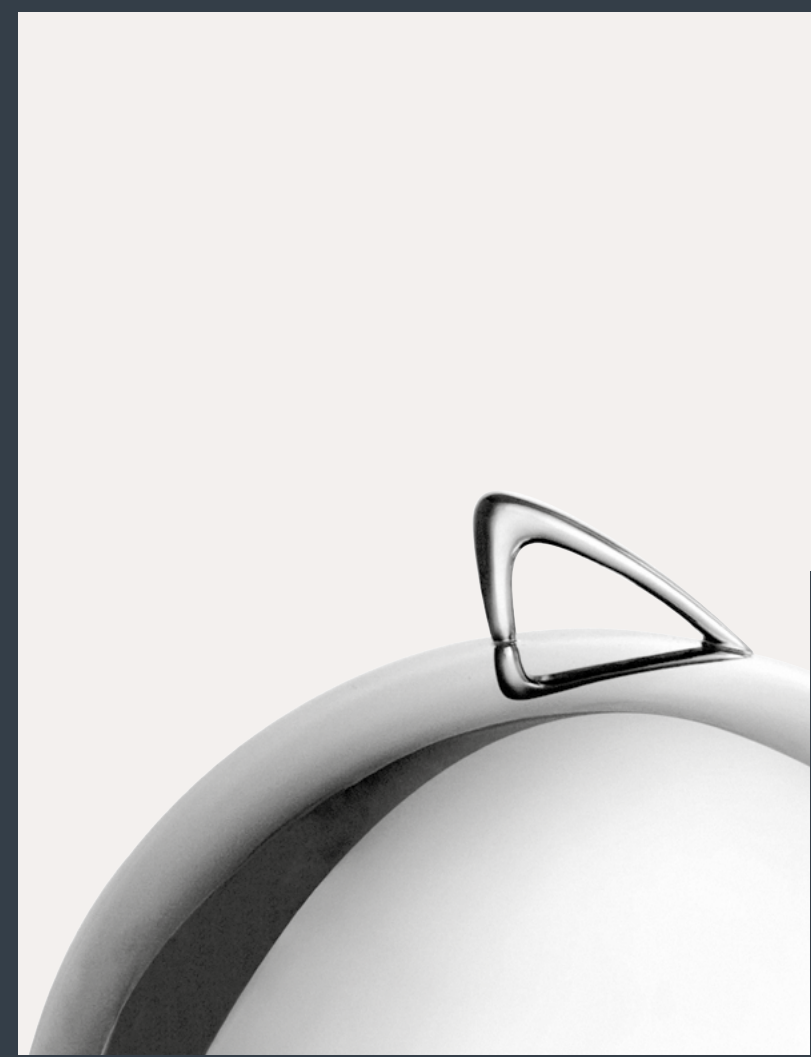

---

## SERVICE DE PERSONNALISATION

---

Créez votre table personnalisée grâce au savoir-faire DEGRENNE. **DEGRENNE rend votre table unique grâce à ses services de personnalisation** : couverts, verres, plateaux ou vaisselle, découvrez un large choix de produits et de finitions. Chaque projet de personnalisation est un **service sur-mesure** qui fait l'objet d'une **étude personnalisée** par nos commerciaux.

---

### PERSONNALIZATION SERVICE

---

Use DEGRENNE's expertise to create your own table. **DEGRENNE's personalization service can make your table unique**: explore our wide range of products and finishes, including cutlery, glasses, trays and tableware. Our sales executives deliver a **bespoke service for each and every personalisation order**.

---

### SERVICIO DE PERSONNALIZACIÓN

---

Cree su mesa personalizada gracias al saber hacer de DEGRENNE. **DEGRENNE hace que su mesa sea única gracias a sus servicios de personalización**: cubiertos, copas, bandejas o vajilla, descubra una amplia elección de productos y de acabados. Cada proyecto de personalización es un **servicio a medida** que es objeto de un **estudio personalizado** por parte de nuestros comerciales.







## VERRERIE

GLASSWARE  
COPAS

AJOUTEZ VOTRE LOGO SUR LE PIED DU VERRE  
AJOUTEZ VOTRE LOGO OU UN TRAIT DE JAUGE SUR LA PARISSON  
(LE LOGO SUR LA PARISSON PEUT ÉGALEMENT FAIRE OFFICE DE JAUGE)

ADD YOUR LOGO TO THE BASE OF THE GLASS  
ADD YOUR LOGO OR A MEASURE MARKING ON THE BOWL  
(THE LOGO ON THE BOWL CAN ALSO BE USED AS THE MEASURE MARKING)

AÑADA SU LOGOTIPO EN LA BASE DE LA COPA  
AÑADA SU LOGOTIPO O UN INDICADOR DE NIVEL EN EL CÁLIZ  
(EL LOGOTIPO EN EL CÁLIZ TAMBIÉN PUEDE SERVIR COMO INDICADOR DE NIVEL)



## VAISSELLE

TABLEWARE  
VAJILLA

AJOUTEZ VOTRE LOGO  
RÉALISEZ UN DÉCOR SPÉCIFIQUE  
APPLIQUEZ UN FILET DE LA COULEUR DE VOTRE CHOIX

ADD YOUR LOGO  
ADD A SPECIAL PATTERN  
APPLY A THIN STRIPE OF THE COLOUR OF YOUR CHOICE

AÑADA SU LOGOTIPO  
REALICE UNA DECORACIÓN ESPECÍFICA  
APLIQUE UN BORDE DE COLOR DE SU ELECCIÓN







## COUVERTS & PLATERIE

FLATWARE  
CUBIERTOS

HOLLOWWARE  
ORFEBRERÍA

**AJOUTEZ VOTRE LOGO : EN FONCTION DE VOS ATTENTES, NOUS PROPOSONS LA GRAVURE LASER POUR UNE GRANDE PRÉCISION OU LE MARQUAGE AU POINÇON POUR UNE TENUE INALTÉRABLE DANS LE TEMPS**

**ADD YOUR LOGO : IN ACCORDANCE WITH YOUR REQUIREMENTS, WE OFFER LASER ENGRAVING IF HIGH PRECISION IS NEEDED, OR ALTERNATIVELY METAL STAMPING FOR ITEMS NEEDING TO STAND THE TEST OF TIME**

**AÑADA SU LOGOTIPO: EN FUNCIÓN DE SUS EXPECTATIVAS, LE PROPONEMOS EL GRABADO LÁSER PARA UNA GRAN PRECISIÓN O EL MARCADO CON PUNZÓN PARA UNA RESISTENCIA EN EL TIEMPO INALTERABLE**



## PERSONNALISEZ VOTRE FINITION

PERSONALIZE THE FINISH  
PERSONALICE SU ACABADO



**L'ARGENTURE AVEC POINÇON DE MAÎTRE : ARGENTURE DE CLASSE I (33 MICRONS POUR LES ARTICLES À USAGE FRÉQUENT) OU ARGENTURE QUALITÉ HÔTELIÈRE (10 MICRONS)**

SILVER PLATING WITH A MAKER'S MARK: CLASS I SILVER PLATING (33 MICRONS FOR FREQUENTLY USED ITEMS) OR HOTEL QUALITY SILVER-PLATING (10 MICRONS)

**LA PLATEADURA CON PUNZÓN DE MAESTRO: PLATEADURA DE CLASE I (33 MICRONES PARA LOS ARTÍCULOS DE USO FRECUENTE) O PLATEADURA DE CALIDAD HOTELERA (10 MICRONES)**



**LA DORURE : DORURE À L'OR FIN DES COUVERTS OU DE CERTAINES PARTIES DES COUVERTS**

GILDING : CUTLERY OR ALTERNATIVELY SOME SECTIONS OF CUTLERY CAN BE GILDED WITH FINE GOLD

**LA DORADURA : DORADURA CON ORO FINO DE LOS CUBIERTOS O DE ALGUNAS PARTES DE LOS CUBIERTOS**



**LA FINITION BROSSÉE OU SATINÉE : POLISSAGE SPÉCIFIQUE DES COUVERTS OU DES ACCESSOIRES DE PLATERIE POUR UN RENDU MAT**

BRUSHED OR SATIN FINISH: SPECIALLY POLISHED CUTLERY AND HOLLOWWARE ACCESSORIES FOR A MATT FINISH

**EL ACABADO MATE O SATINADO : PULIDO ESPECÍFICO DE LOS CUBIERTOS O DE LOS ACCESORIOS DE PLATERÍA PARA UN ACABADO MATE**

**LA FINITION ÉTAÏN : POLISSAGE SPÉCIFIQUE DES COUVERTS POUR UN EFFET VIEILLI FAÇON ÉTAÏN**

PEWTER FINISH: SPECIALLY POLISHED CUTLERY FOR A PEWTER-STYLE ANTIQUE EFFECT

**EL ACABADO DE ESTAÑO : PULIDO ESPECÍFICO DE LOS CUBIERTOS PARA UN EFECTO ENVEJECIDO TIPO ESTAÑO**

**LA FINITION PVD : PROCÉDÉ DE MÉTALLISATION QUI PERMET DE RÉALISER UN PLACAGE IONIQUE, DISPONIBLE DANS LES COLORIS NOIR, DORÉ, CUIVRE ET HOLOGRAPHIC SOUS CONDITIONS PARTICULIÈRES, CONTACTEZ NOS ÉQUIPES.**

PVD FINISH: VACUUM DEPOSIT METALLIZATION PROCESS. AVAILABLE IN BLACK, GOLD, COPPER AND HOLOGRAPHIC COLORS UNDER SPECIAL CONDITIONS, CONTACT OUR SALES TEAMS.

**RECUBRIMIENTO PVD: PROCEDIMIENTO DE METALIZACIÓN POR DEPÓSITO AL VACÍO. DISPONIBLE EN LOS COLORIDOS NEGRO, DORADO, COBRE Y HOLOGRÁFICA BAJO CONDICIONES PARTICULARES, PÓNGASE EN CONTACTO CON NUESTROS EQUIPOS.**



Handwriting practice area on the left page, consisting of 25 horizontal dotted lines.

Handwriting practice area on the right page, consisting of 25 horizontal dotted lines.





Handwriting practice area on the left page, consisting of 25 horizontal dotted lines.

Handwriting practice area on the right page, consisting of 25 horizontal dotted lines.







**DESCENTE INTERNATIONALE**  
INTERNATIONAL RANGE  
GAMA INTERNACIONAL



**SÉLECTION DEGRENNE :**  
Produits emblématiques de la  
marque disponibles rapidement  
pour vos commandes prioritaires

DEGRENNÉ'S SELECTION :  
The brand's flagship products made available  
quickly for your priority product orders

SELECCION DEGRENNE :  
Productos emblemáticos de la marca  
disponibles rápidamente para sus pedidos  
prioritarios



**GARANTIE MICRO-ONDES**  
MICROWAVE SAFE  
GARANTÍA MICRO-ONDAS



**GARANTIE LAVE-VAISSELLE**  
DISHWASHER SAFE  
GARANTÍA LAVA-VAJILLAS



**GARANTIE CONGÉLATEUR**  
FREEZER SAFE  
GARANTÍA CONGELADOR



**GARANTIE FOUR**  
OVEN SAFE  
GARANTÍA HORNO



**FINITION MÉTAL ARGENTÉ - ARGENTURE  
CLASSE 1 - 33 MICRONS (POUR LES  
ARTICLES À USAGE FRÉQUENT )**  
SILVER PLATED FINISH - CLASS 1 SILVERPLATING -  
33 MICRONS  
ACABADO PLATEADO - TIPO CLASE 1 - 33 MICRAS



**ARGENTURE QUALITÉ HÔTELIÈRE -  
10 MICRONS**  
SILVER PLATED HOTEL QUALITY- 10 MICRONS  
ACABADO HOTEL QUALITY - 10 MICRONES



**FINITION MIROIR**  
MIRROR FINISH  
ACABADO BRILLO



**FINITION SATINÉE**  
SATIN FINISH  
ACABADO CEPILLADO



**FINITION VINTAGE**  
VINTAGE FINISH  
ACABADO VINTAGE



**FORGÉ**  
FORGED  
FORJADO



**ACIER INOXYDABLE**  
STAINLESS STEEL  
ACERO INOXIDABLE



**EPAISSEUR FOURCHETTE DE TABLE**  
THICKNESS TABLE FORK  
ESPESOR TENEDOR DE MESA



**RÉASSORT**  
REPLACEMENT  
RENOVACIÓN



**REVÊTEMENT PVD**  
PVD COATING  
REVESTIMIENTO PVD



**VERRE**  
GLASS  
CRISTAL



**SHQ/ SODOCALCIQUE  
HAUTE QUALITÉ**  
HIGH QUALITY SODA - LIME  
SODOCALCICO ALTA CALIDAD



**CRISTALLIN HAUTE QUALITÉ**  
HQ LOW LEAD CRYSTAL  
CRISTALINO ALTA CALIDAD



**VERRE SOUFFLÉ BOUCHE TEINTÉ  
DANS LA MASSE**  
HAND-BLOWN INTEGRALLY DYED GLASS  
VASO SOPLADO A BOCA, PINTADO EN MASA



**1000 CYCLES GARANTIS MINIMUM**  
1000 WASH CYCLES GUARANTEED  
1000 CICLOS DE LAVADO GARANTIZADOS



**PORCELAINE**  
PORCELAIN  
PORCELANA



**PORCELAINE DE LIMOGES**  
LIMOGES PORCELAIN  
PORCELANA DE LIMOGES



**AIMANTÉ**  
WITH MAGNET  
CON IMÁN



**GRÈS**  
STONEWARE  
ARENISCA

MARQUES DÉPOSÉES/COPYRIGHTS / MARCAS REGISTRADAS



L'ECONOME®



LAGUIOLE®  
ROSSIGNOL

FRANCE USA

**SIEGE SOCIAL / HEAD OFFICE / SEDE SOCIAL**  
**SERVICE CLIENTS / CUSTOMER SERVICES / ATENCIÓN AL CLIENTE**

RUE GUY DEGRENNE - BP 50056  
14502 VIRE CEDEX  
FRANCE  
TEL : +33 (0)2 31 66 44 15

OTHER COUNTRIES / OTROS PAÍSES  
TEL : +33 (0)2 31 66 44 92

infohotel@degrenne.fr

**FILIALE USA - US SUBSIDIARY**

DNA/DEGRENNÉ NORTH AMERICA INC.  
390 GEORGE STREET - SUITE 404 - NEW BRUNSWICK  
NJ 08901 USA  
TEL : 732 565 0820  
FAX : 732 565 0828

csrv.dna@degrenneparis.com  
www.degrenneparis.us

**DIRECTION GÉNÉRALE / GENERAL MANAGEMENT / DIRECCIÓN GENERAL**  
**DIRECTION MARKETING - MARKETING DIVISION - DIRECCIÓN DE MARKETING**  
**DIRECTION COMMERCIALE - SALES DIVISION - DIRECCIÓN COMERCIAL**

**SHOWROOMS (SUR RENDEZ-VOUS)**  
PARIS (89 RUE LA BOÉTIE - 75008 PARIS)  
NEW YORK (41 MADISON)

89 RUE LA BOÉTIE  
75008 PARIS  
FRANCE







# ROUGE PLUS

Vi EQUIPEMENT

160 Avenue Paul Vaillant Couturier

93120 LA COURNEUVE

tel.: +33 (0)1 75 43 77 96

fax: +33 (0)1 75 43 77 97

site web: [www.rougeplus.com](http://www.rougeplus.com)

email: [contact@rougeplus.com](mailto:contact@rougeplus.com)