

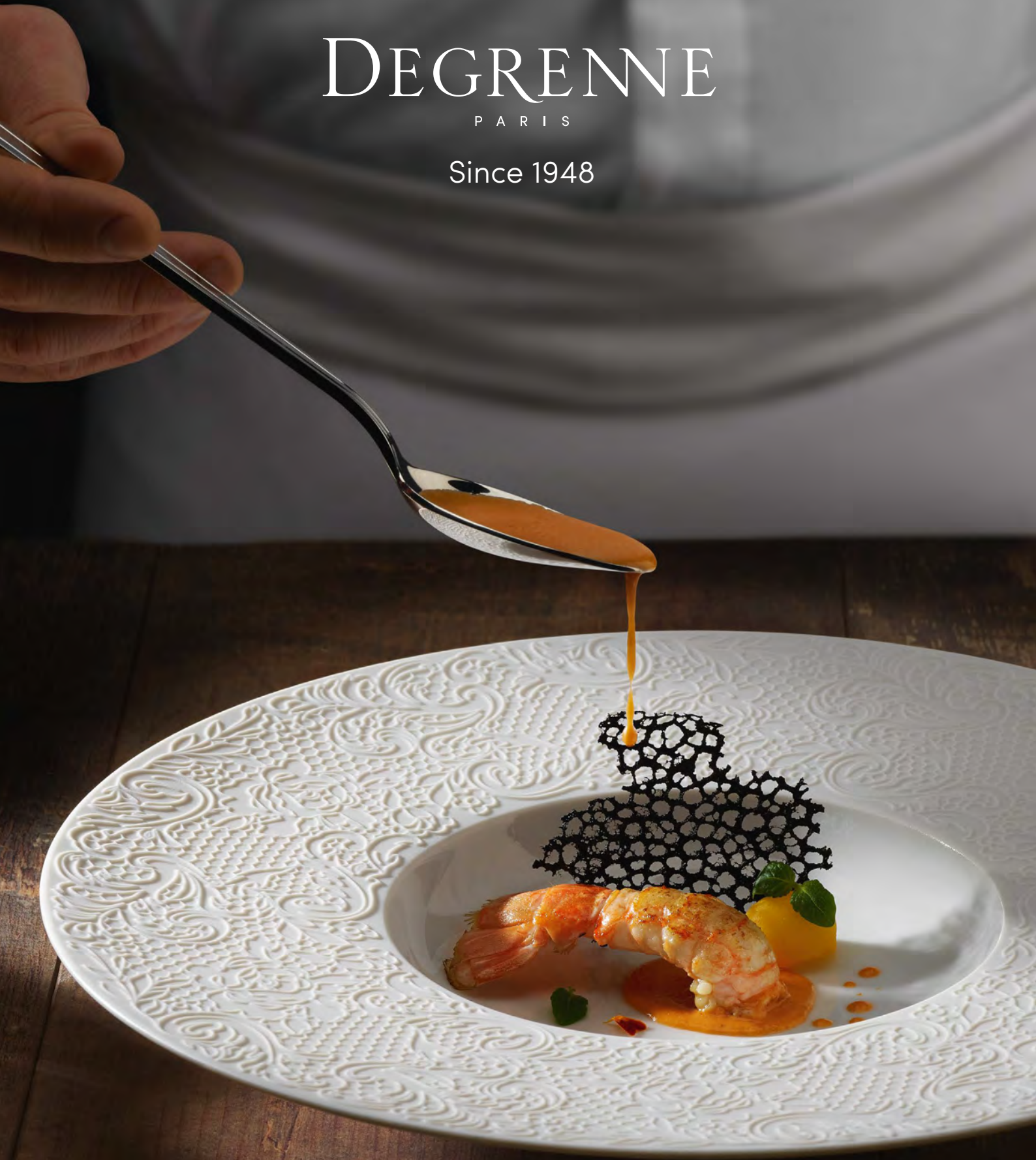

# DEGRENNE

P A R I S

Since 1948



2020





# DEGRENNÉ

P A R I S



DEGRENNÉ c'est l'histoire d'une formidable aventure humaine et industrielle. Née en 1948, elle a su traverser le temps et marquer les tables de son empreinte. 70 ans plus tard, la Maison DEGRENNE accompagne les hôteliers et les restaurateurs à travers le monde où la marque défend les belles valeurs de la Gastronomie et de l'Art de Vivre à la Française. Avec ses collections identitaires de couverts, vaisselle et verrerie, elle a l'honneur de s'inviter sur les plus belles tables pour sublimer les créations de chefs.

DEGRENNÉ est un fabricant français qui arbore avec fierté le label Entreprise du Patrimoine Vivant. C'est notamment dans ses usines de Vire et de Limoges, que ses artisans passionnés par les métiers de la porcelaine et de l'inox, perpétuent des savoir-faire transmis de génération en génération et sont toujours prêts à relever de nouveaux défis. Demain, DEGRENNE continuera plus que jamais à faire rayonner avec passion l'image de la France, à défendre ses savoir-faire et à cultiver l'esprit d'innovation, si fortement ancré dans son ADN, pour incarner le renouveau de l'Art de Vivre.

DEGRENNÉ Paris. L'Art de Vivre. Aujourd'hui & Demain.

---

DEGRENNÉ is the story of a fantastic human and industrial adventure. Founded in 1948, it has withstood the test of time and made its mark on the dining experience. Seventy years later, Maison DEGRENNE is supporting hoteliers and restaurateurs around the world, as a brand promoting the noble values of gastronomy and the French Art of Living. With its unmistakable collections of cutlery, tableware and glassware, it has the honour of setting off creations at the tables of the finest chefs.

DEGRENNÉ is a French manufacturer proud to have been named an "Entreprise du Patrimoine Vivant" (living heritage company). Especially in its factories of Vire and Limoges, its passionate porcelain and steel craftsmen perpetuate know-how passed down from generation to generation, and are always ready to take up new challenges. Looking to the future, DEGRENNE is more committed than ever to its passionate quest to promote the prestige of France, to champion its know-how and to cultivate the spirit of innovation so strongly rooted in its heritage, in order to embody a renaissance in the Art of Living.

DEGRENNÉ Paris. The Art of Living. Today & Tomorrow.

---

DEGRENNÉ es la historia de una formidable aventura humana e industrial. Desde su nacimiento en 1948, ha sabido perdurar y dejar huella en la mesa. Han pasado 70 años y la casa DEGRENNE sigue al lado de los profesionales de la hostelería y la restauración en todo el mundo, defendiendo los grandes valores de la gastronomía y el arte de vivir a la francesa. Con sus inconfundibles colecciones de cubertería, vajilla y cristalería, tiene el honor de invitarse a las mejores mesas para sublimar las creaciones culinarias.

DEGRENNÉ es un fabricante francés que ostenta con orgullo el sello de excelencia Entreprise du Patrimoine Vivant. Principalmente en sus instalaciones de Vire y Limoges, sus artesanos, apasionados por los oficios de la porcelana y el acero inoxidable, perpetúan técnicas transmitidas de generación en generación, siempre dispuestos a asumir nuevos desafíos. DEGRENNE mira al futuro para seguir transmitiendo con pasión la brillante imagen de Francia, defender su saber hacer y cultivar el espíritu de innovación, tan arraigado en su ADN, con el fin de encarnar la renovación del arte de vivir.

DEGRENNÉ Paris. El arte de vivir. Hoy y mañana.

Géraldine Hottier-Fayon  
Présidente du groupe DEGRENNE



---

## FAIRE NAITRE LES PLUS BELLES EMOTIONS!

---

Les collections DEGRENNE habillent les plus belles tables du monde et célèbrent **le renouveau de la Gastronomie Française et Internationale**. Elles inspirent les professionnels de l'hôtellerie et de la restauration pour **mettre en lumière leurs créations** et **sublimer le service à table**. Plus que des produits ce sont **de véritables outils de dégustation** créés pour **faire naître les plus belles émotions**.

---

### CREATING THE MOST BEAUTIFUL EMOTIONS!

---

The DEGRENNE collections adorn the finest tables in the world and celebrate **the revival of French and international gastronomy**. They inspire professionals in the hotel and catering industry, **showcasing their creations** and **enhancing table service**. These are not simply products, they are **real tasting tools**, created **to stir the most uplifting emotions**.

---

### ¡DESPEITAR LAS MÁS BELLAS EMOCIONES!

---

Las colecciones de DEGRENNE visten las mesas más hermosas del mundo y celebran **la renovación de la gastronomía francesa e internacional**. Inspiran a los profesionales de la hostelería y la restauración para dar **protagonismo a sus creaciones** y **sublimar el servicio de mesa**. Más que objetos son **auténticas herramientas de degustación** creadas para **despertar las más bellas emociones**.



©Emanuel Machado - Brasserie of Light, Selfridges - London, UK



©Vincent Ménager - STK London - London, UK



©Dominic Grundy - Panoramic 34 - Liverpool, UK



© Ana Grgić - Esplanade Zagreb Hotel - Restaurant Zinfandel's - Zagreb, HR



© Mike Reid - M Restaurant - London, UK



©Frédéric Don - Sketch - London, UK



©Vincent Ménager - STK London - London, UK



©Christian Tetedoie - Restaurant Tetedoie - Lyon, FR





## LA NAISSANCE D'UNE GRANDE MAISON FRANÇAISE

Fondée en 1948, La Maison DEGRENNE est une **formidable histoire d'entrepreneuriat** portée par un homme visionnaire, Guy Degrenne, qui se lance dans la quête de **repenser les Arts de la Table** en démocratisant l'Orfèvrerie.

Clairvoyant, le jeune entrepreneur normand avait compris le potentiel de l'acier inoxydable pour fabriquer des couverts et avait perçu, dans la France d'après-guerre, le **désir de modernité**. Avec **audace, passion et détermination**, il allait marquer les tables de son empreinte et hisser son entreprise au rang de leader du marché.

Aujourd'hui, la Maison DEGRENNE s'attache toujours à **répondre aux envies de ses clients** avec ses collections de couverts, vaisselle, platerie, ou encore de verrerie.

Forte du **savoir-faire unique de ses artisans**, la marque s'inscrit dans son époque et cultive **l'esprit d'innovation**, si fortement ancré dans son ADN, pour incarner le **renouveau de l'Art de Vivre à la française** !

### THE CREATION OF A GREAT FRENCH FIRM

Founded in 1948, La Maison DEGRENNE is a **fantastic story of entrepreneurship** started by Guy Degrenne, a visionary who embraced the quest to **reinvent tableware** by bringing high-end metalwork skills to everyday dining.

The far-sighted young entrepreneur from Normandy had understood the potential of stainless steel for manufacturing cutlery and perceived **the desire for modernity** in post-war France. With **boldness, passion and determination**, he would make his mark on the dining experience and develop his company to become a market leader.

Today, Maison DEGRENNE is still just as committed to **meeting the desires of its customers** with its collections of cutlery, dinnerware, flatware and glassware.

Building on the **unique expertise of its craftsmen**, the brand embraces modernity and cultivates the **spirit of innovation** so deeply rooted in its heritage, in order to embody a **renaissance in the French Art of Living!**

### ¡EL NACIMIENTO DE UNA GRAN CASA FRANCESA!

La casa DEGRENNE, fundada en 1948, es fruto de **una formidable historia de emprendimiento** impulsada por un visionario, Guy Degrenne, que se impuso la tarea de **transformar el arte de la mesa** y democratizar la orfebrería.

Este joven normando, resuelto y lúcido, supo entender el potencial del acero inoxidable para fabricar cubiertos y percibió el **deseo de modernidad** que se respiraba en la Francia de la posguerra. Con **audacia, pasión y determinación**, consiguió dejar su huella en las mesas y elevar su empresa a la categoría de líder del mercado.

Hoy, la casa DEGRENNE sigue dedicada a **satisfacer las necesidades de sus clientes** con sus colecciones de cubertería, vajilla, orfebrería y cristalería.

Gracias a la **excepcional maestría de sus artesanos**, la marca se adapta a los tiempos, sin dejar nunca de cultivar el **espíritu de innovación** que lleva anclado en su ADN, para reencarnar la **renovación del arte de vivir a la francesa**.

## NOTRE PASSION: VOUS INSPIRER



Entreprise  
du Patrimoine  
Vivant  
L'excellence  
des savoir-faire  
français

Avec vous, nous désirons partager une véritable **culture de l'art de vivre**. Quelque soit votre approche élégante, innovante, sobre ou luxuriante, la Maison DEGRENNE dessine pour vous les collections qui sauront conter votre cuisine : **courbes, matières, couleurs, chaque détail compte** pour souligner votre travail. Tout comme le vôtre, notre métier exige de **la rigueur et le sens du détail**. Nous avons la passion du «beau» pour vous inspirer le meilleur. Cette passion est initiée dès sa fondation, il y a 70 ans, par **Guy Degrenne**. Aujourd'hui, la Maison DEGRENNE arbore avec fierté le label **Entreprise du Patrimoine Vivant**, qui consacre l'excellence artisanale et industrielle française.

### OUR PASSION: INSPIRING YOU

We wish to share a genuine **lifestyle culture** with you. Whatever your approach, whether elegant, innovative or luxurious, the Maison DEGRENNE will design collections for you, which will tell the story of your cuisine: **curves, materials, colours... every detail will enhance** your work. Just like you, our profession requires us to have **a strong work ethic and be detail-orientated**. We have a passion for the "beautiful" to inspire your best work. This passion was first generated, 70 years ago, by **Guy Degrenne**, when he created the company. Today, the Maison DEGRENNE proudly bears the "**Entreprise du Patrimoine Vivant**" (living heritage company) label, a testament of French artisanal and industrial excellence.

### NUESTRA PASIÓN: INSPIRARLE

Deseamos compartir con usted una auténtica **cultura del disfrute de la vida**. Con independencia de que su oferta sea elegante, innovadora, sobria o lujosa, la firma DEGRENNE diseña colecciones a imagen y semejanza de su cocina: **curvas, materiales, colores... cada detalle cuenta** para realzar sus creaciones. Nuestra profesión, como la suya, **exige rigor y atención al detalle**. Nos apasiona lo bello para inspirarle mejor. Esta pasión se inició desde la fundación de la firma, hace setenta años, por **Guy Degrenne**. En la actualidad, la firma DEGRENNE exhibe con orgullo su certificación de **Entreprise du Patrimoine Vivant** (empresa del patrimonio vivo), que reconoce la excelencia artesanal e industrial francesa.



---

## FIER DE NOS ARTISANS!

---

À Vire comme à Limoges, c'est l'excellence d'hommes et de femmes passionnés par leur métier, qui perpétuent **des savoir-faire transmis de génération en génération** et sont toujours prêts à **relever de nouveaux défis**. Chaque artisan contribue à notre histoire, chaque parcours témoigne de **la richesse de nos compétences**. Le souci de **la qualité, la rigueur technique et l'art du geste bien accompli** sont les critères d'exigences communs à tous.

---

### PROUD OF OUR ARTISANS!

---

Both in Vire and Limoges, men and women who are passionate about their profession perpetuate the **savoir-faire that has been transmitted from generation to generation** and are always ready to **take on new challenges**. Each artisan contributes to our story and every pathway bears witness to **the wealth of our abilities**. We require each artisan to be devoted to **high quality, rigorous technique and well accomplished handiwork**.

---

### ¡ORGULLOSOS DE NUESTROS ARTESANOS!

---

Tanto en Vire como en Limoges, unos trabajadores apasionados por su oficio perpetúan **las tradiciones transmitidas de generación en generación**, siempre dispuestos a **superar nuevos desafíos**. Cada artesano contribuye a nuestra historia; cada recorrido da fe de la **riqueza de nuestras competencias**. La atención a la **calidad, el rigor técnico y el saber hacer** son nuestros criterios y exigencias comunes.







7,5

MILLIONS DE PIÈCES PRODUITES CHAQUE ANNÉE

MILLION PIECES PRODUCED EACH YEAR

MILLONES DE PIEZAS PRODUCIDAS CADA AÑO

1300

RÉFÉRENCES CHR

HORECA REFERENCES  
REFERENCIAS CHR



70

ANS D'EXCELLENCE DEPUIS 1948

YEARS OF EXCELLENCE SINCE 1948  
AÑOS DE EXCELENCIA DESDE 1948

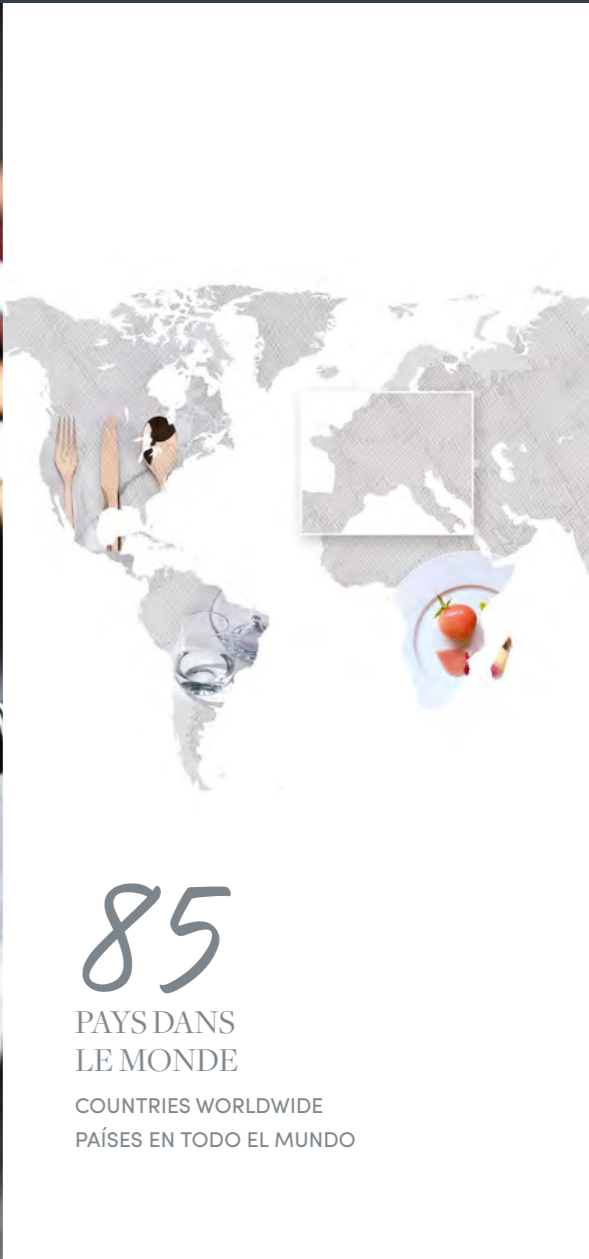
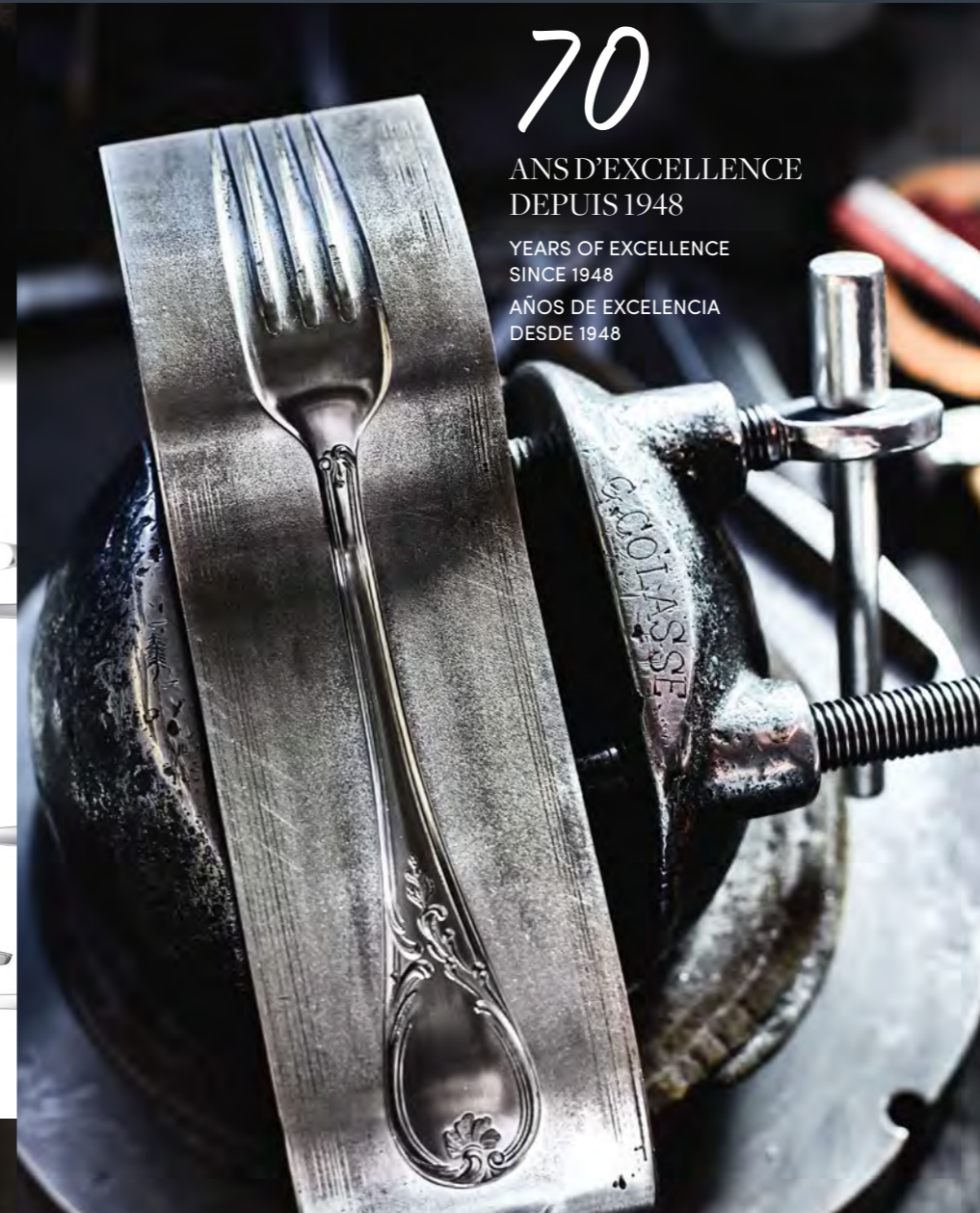

85

PAYS DANS LE MONDE

COUNTRIES WORLDWIDE  
PAÍSES EN TODO EL MUNDO



750

COLLABORATEURS

PARTNERS  
EMPLEADOS

3

USINES

FACTORIES  
FÁBRICAS





## ILS NOUS FONT CONFIANCE

THEY TRUST US  
NOS DEPOSITAN SU CONFIANZA

LE FOUQUETS  
SOCIÉTÉ DES BAINS DE MER  
LUTETIA  
WALDORF ASTORIA  
PENINSULA  
PLAZA  
ELEVEN MADISON PARK  
BELLAGIO  
MARRIOTT / STARWOOD / SHERATON  
FOUR SEASONS  
HILTON WORLDWIDE  
ACCOR HOTELS  
PULLMAN  
SOÏTEL / BARRIÈRE  
M GALLERY / MAMA SHELTER  
NOVOTEL  
MERCURE  
IBIS  
INTERCONTINENTAL  
RITZ CARLTON  
LOUVRE HOTELS  
GOLDEN TULIP  
CAMPANILE  
KYRIAD  
FAIRMONT / RAFFLES HOTELS  
SWISSOTEL  
W HOTELS



## PARTENAIRES DE L'EXCELLENCE

PARTNERS IN EXCELLENCE  
SOCIOS DE LA EXCELENCIA

LES CUISINIERS DE LA RÉPUBLIQUE  
LES MAÎTRES CUISINIERS DE FRANCE  
ACADÉMIE CULINAIRE DE FRANCE  
CLUB DES DIRECTEURS DE LA RESTAURATION  
ET DE L'EXPLOITATION  
LES TOQUES BLANCHES LYONNAISES  
COUPE GEORGES BAPTISTE  
FERRANDI  
L'ÉCOLE FRANÇAISE DE GASTRONOMIE  
INSTITUT PAUL BOCUSE  
ÉCOLE DE MANAGEMENT L'HOTELLERIE  
RESTAURATION  
GLION - SUISSE  
INSTITUTE OF HIGHER EDUCATION  
BEST  
ÉCOLE DE BORDEAUX  
AFLYHT  
ASSOCIATION FRANÇAISE DES LYCÉES  
D'HOTELLERIE ET DE TOURISME  
LES TOQUES NORMANDES  
ARYZTA FOOD SOLUTIONS  
EURO TOQUES - SUISSE





# 2

## SHOWROOMS



### PARIS

#### NEW YORK

41 MADISON

# 3

## SITES DE PRODUCTION

PRODUCTION SITES  
PLANTAS DE PRODUCCIÓN

### VIRE / FRANCE

COUVERTS ET PLATERIE  
FLATWARE AND HOLLOWARE  
CUBIERTOS E ORFEBRERÍA

### LIMOGES / FRANCE

VAISSELLE  
DINNERWARE  
VAJILLA

### ALFOLD / HONGRIE

VAISSELLE  
DINNERWARE  
VAJILLA





# RESTAU RATEUR

FOOD SERVICE  
RESTAURACION

---

## L'EXCELLENCE POUR CHACUN DE VOS BESOINS

---

DEGRENNÉ propose une gamme de produits d'art de la table inégalée et **adaptée aux besoins de chaque établissement**. Pour vous offrir les meilleurs produits, nous mettons **l'usage au cœur de nos réflexions** et cultivons **une identité qui nous est propre**. Choisis par de nombreux experts de la restauration à travers le monde, les produits DEGRENNÉ se distinguent par leur **excellence, fonctionnalité et élégance**.

---

### EXCELLENCE FOR EACH OF YOUR NEEDS

---

DEGRENNÉ offers an unrivalled range of tableware products **adapted to the needs of each establishment**. To offer you the best products, **we focus on how our products will be used** and cultivate **our own unique identity**. Chosen by numerous leading restaurateurs around the world, DEGRENNÉ products stand out for their **excellence, functionality and elegance**.

---

### EXCELENCIA PARA SATISFACER TODAS SUS NECESIDADES

---

DEGRENNÉ oferta una excepcional gama de productos para la mesa **adaptada a las necesidades de todos los establecimientos**. Nuestra norma de diseño es **darle prioridad al uso al tiempo** que cultivamos **una identidad propia**. Numerosos especialistas de la restauración de todo el mundo eligen los productos DEGRENNÉ por su **excelencia, funcionalidad y elegancia**.



# HOTE LIER

HOSPITALITY  
HOSTELERIA



# LOU EUR

CATERING  
CATERING

# L'EXCELLENCE CULINAIRE

CULINARY EXCELLENCE  
LA EXCELENCIA CULINARIA

Parce que l'art du bon exige l'art du beau, nous développons des **collections de caractère**, d'une **qualité exceptionnelle** qui sublimeront vos mets délicats. Une invitation au plus beau voyage des sens...

Because excellent performance goes hand in hand with beauty, we develop **collections with character** and of **exceptional quality** that will exalt your delicate dishes – an invitation on the most beautiful journey of the senses...

Lo bueno es sinónimo de lo bello, por eso desarrollamos **coleccionces con carácter**, con una **soberbia calidad** que realzará sus platos más delicados. Una invitación para disfrutar del mejor viaje sensorial...

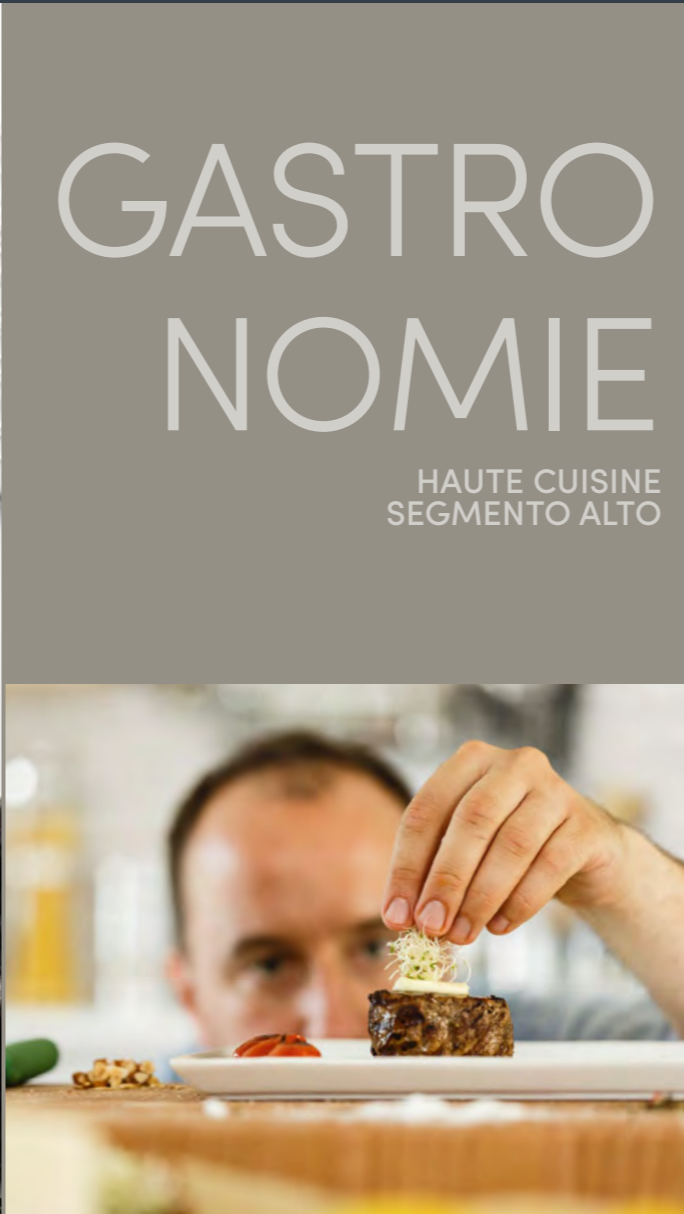

L'EXCELLENCE POUR CHACUN DE VOS BESOINS

EXCELLENCE FOR EACH OF YOUR NEEDS - EXCELENCIA PARA SATISFACER TODAS SUS NECESIDADES

# GASTRONOMIE

HAUTE CUISINE  
SEGMENTO ALTO

**A L FRAGMENT**  
227848 - ASSIETTE GOURMET  
SHALLOW BOWL - PLATO GOURMET P.36

**BAHIA**  
230944 - BOL COCOTTE  
ROUND CASSEROLE - BOL COCOTTE P.68

**B L COUTURE**  
237399 - ASSIETTE PLATE  
DINNER PLATE - PLATO REDONDO P.34

237400 - ASSIETTE DESSERT  
DESSERT PLATE - PLATO REDONDO P.34

**C L FRAGMENT**  
227843 - ASSIETTE DE PRESENTATION  
PRESENTATION PLATE - PRESENTACION REDONDO P.36

**COCOTTES**  
234336 - ASSIETTE COCOTTE  
CASSEROLE PLATE - PLATO COCOTTE P.68

## TRADITION REVISITEE

A NEW APPROACH TO TRADITION  
LA TRADICIÓN ACTUALIZADA

Nos **formes et matières contemporaines** vous permettront d'exprimer toute **votre créativité** ! Elles souligneront une **cuisine inventive et gourmande** complice d'une nouvelle expérience culinaire dans un esprit de convivialité et de partage.

Our **contemporary designs and materials** will allow you to fully express **your creativity**! They will set off **inventive and delicious cuisine** that is part of a new culinary experience in a spirit of sociability and sharing.

¡Nuestras **formas y materiales contemporáneos** le permitirán expresar toda **su creatividad**! Son un medio para destacar **una cocina inventiva y exquisita**, cómplice de una nueva experiencia culinaria bajo el signo de la convivencia y el deseo de compartir.



# BISTRONOMIE

BISTROS  
SEGMENTO MEDIO



**A L'E STARCK**  
233011 - FOURCHETTE DE TABLE P.108  
TABLE FORK - TENEDOR DE MESA

**B COCOTTES**  
230970, 230942, 230956 - BOL BISEAUTÉ  
COCOTTE - SLANTED RIM BOWL - P.69  
BOL BISEADO COCOTTE

**C BORÉAL**  
207134 - ASSIETTE PLATE OVALE P.44  
OVAL DINNER PLATE - PLATO OVAL  
207136 - ASSIETTE CALOTTE P.44  
SHALLOW BOWL - COUPE PLATE HONDO

**D BAHIA ONYX**  
236548 - ASSIETTE PLATE P.70  
DINNER PLATE - PLATO REDONDO

**E L'E STARCK**  
237297 - ASSIETTE PLATE - ROUND DINNER  
PLATE - PLATO REDONDO P.50  
237334 - GRANDE ASSIETTE CREUSE RONDE LARGE  
DEEP PLATE - PLATO REDONDO P.52

**F MODULO NATURE**  
194457 - COUPE/CALOTTE - SALAD/CEREAL PLATE, DEEP  
BOL P.76

## PATRIMOINE CULINAIRE

CULINARY HERITAGE  
PATRIMONIO CULINARIO

**Générosité et authenticité** constituent l'esprit de la Brasserie. Nos collections de produits, **épurés et pratiques**, se mettent **au service de votre carte** pour mettre en valeur avec simplicité ce patrimoine culinaire.

**Generosity and authenticity** are at the heart of the brasserie experience. Our **refined and functional** collections **enhance your menu** by showcasing this culinary heritage with simplicity.

**La generosidad y la autenticidad** constituyen el espíritu del segmento más accesible. Nuestras colecciones de productos, **sobrias y prácticas**, se ponen al servicio de su carta para dar protagonismo con sencillez a su patrimonio culinario.



- |   |      |  |
|---|------|--|
| <b>A SMOOS</b>  |      |  |
| 207766 - TASSE À EXPRESSO - EXPRESSO CUP - EXPRESSO TAZA            | P.92 |  |
| 161025 - SOUCOUBE - ESPRESSO SAUCER - ESPRESSO PLATO                |      |  |
| <b>B ECLIPSE</b>  |      |  |
| 234607 - ASSIETTE PLATE - DINNER PLATE                              | P.62 |  |
| PLATO REDONDO   |      |  |
| <b>C ECLIPSE</b>  |      |  |
| 234609 - ASSIETTE CREUSE CALOTTE - ROUND CEREAL PLATE - PLATO HONDO | P.62 |  |
| <b>D ECLIPSE</b>  |      |  |
| 234604 - BOL À SALADE - SALAD BOWL - BOL DE ENSALADA                | P.62 |  |



## L'ART DE L'ACCUEIL

THE ART OF HOSPITALITY  
EL ARTE DE RECIBIR

Tout au long de leur séjour, offrez une **expérience sur mesure à vos clients**. Nos **produits modulaires** et aux **finitions délicates** sont adaptés aux besoins de chaque instant, pour **sublimer votre accueil**.

Offer your customers a **tailor-made experience** throughout their stay. Our **modular products** and **delicate finishes** are tailored to the needs of every moment to **heighten your guests' experience**.

Ofrezca una **experiencia personalizada** a sus clientes durante toda su estancia. Nuestros **productos modulares** de **acabados delicados** se adaptan a las necesidades de cualquier momento para **brindar una bienvenida de primera**.



# HOTELIER

HOSPITALITY  
HOSTELERIA



- A MUSE/DOLCE/LOOP**  
GOBELETS - TUMBLERS - VASOS P.212-214
- B EVENTO**  
BUFFET EVENTO - EVENTO BUFFET - BUFÉ EVENTO P.218-241
- C NEWPORT**  
207763 - VERSEUSE - COFFEE/TEA POT P.90  
CAFETERA TETERA  
213854 - CREMIER - CREAM JUG - LECHERA P.184
- D NEWPORT**  
182614 - CLOCHE ASSIETTE - DOME COVER, STAINLESS STEEL P.188  
CAMPANA  
185022 - PLATEAU RECTANGULAIRE AVEC ANSES - RECTANGULAR P.178  
SERVING TRAY WITH HANDLES - BANDEJA RECTANGULAR CON ASAS
- E NORMANDY**  
232963 - FOURCHETTE DE TABLE - TABLE FORK P.142  
TENEDOR DE MESA  
232966 - COUTEAU DE TABLE - TABLE KNIFE - CUCHILLO DE MESA P.142
- L PERLES DE ROSÉE**  
233923 - ASSIETTE PLATE - ROUND DINNER PLATE - P.38  
PLATO REDONDO



## L'ART DE LA RÉCEPTION

THE ART OF RECEPTION  
EL ARTE DE LAS RECEPCIONES

Sublimer la magie des **instants précieux** en invitant à la lumière de la **journée** ou d'une **soirée** nos gammes de produits qui **célèbrent l'art du moment**.

Enhance the magic of **precious moments** by allowing our collections to **help you celebrate** an unforgettable **day or evening**.

Nuestras gamas de productos, que **celebran el arte del momento**, subliman el encanto de **los instantes más preciosos** a la luz del **día** o durante una **noche mágica**.



# LOU EUR

CATERING  
CATERING

**A ANYTIME**  
184567 - FLUTE À CHAMPAGNE - CHAMPAGNE FLUTE  
FLAUTA CHAMPÀN P.210

**NEWPORT**  
184180 - SEAU À CHAMPAGNE 2 BOUTEILLES - CHAMPAGNE BUCKET  
CHAMPAGNE BUCKET 2 BOTTLES - CHAMPANERA P.186

**B LA VAISSELLE DE L'ECONOME BY STARCK**  
ASSIETTES PLATES RONDES 14 CM - DINNER PLATES 5 IN<sup>1/2</sup> - PLATOS  
REDONDO 14 CM P.50-52

**C EVENTO**  
BUFFET EVENTO - EVENTO BUFFET - BUFÉ EVENTO P.218 - 241

**D L FRAGMENT**  
227829 - TASSE LUNGO - COFFEE/TEA CUP - LUNGO TAZA P.36  
227850 - SOUCOUPE LUNGO - COFFEE/TEA SAUCER - LUNGO PLATO

**E HERITAGE**  
234103 VERRE À VIN ROUGE - RED WINE GLASS - COPA DE VINO P.192  
234104 VERRE À VIN BLANC - WHITE WINE GLASS - COPA DE VINO



---

## VAISSELLE

---

DEGRENNE travaille les formes et les matières en portant une attention particulière aux **attentes des chefs**, tant esthétiques que dans l'usage. Pour faire de la table un moment dédié aux **plaisirs gastronomiques**, du plus simple au plus élaboré, DEGRENNE imagine **des collections uniques qui incarnent l'excellence et qui peuvent être associées entre elles**. En jouant sur les combinaisons, les contrastes, les formes, les couleurs et les matières, chaque mets trouve harmonieusement sa place à table, avec **élégance et sobriété**. **Matières nobles, lignes épurées**, épousez tous les savoir-faire DEGRENNE lorsque vous dressez votre table.

---

### DINNERWARE

---

DEGRENNE develops shapes and materials, while paying careful attention to **chefs' practical usage** and aesthetic requirements. DEGRENNE designs **unique collections that are the very embodiment of excellence and can also be combined**, in order to make dining a moment of **culinary pleasure**, from the simplest to the most elaborate pleasures. Each dish harmoniously finds its rightful place on the table, with **simplicity and elegance**, thanks to the combinations, contrasts, shapes, colours and materials employed by DEGRENNE. Capitalize on DEGRENNE's extensive expertise when setting your table : we offer **sleek lines and the finest materials**.

---

### VAJILLA

---

DEGRENNE trabaja las formas y los materiales prestando una atención particular a las **expectativas de los chefs**, tanto estéticas como de uso. Para convertir la mesa en un momento dedicado a los **placeres gastronómicos**, del más sencillo al más elaborado, DEGRENNE imagina **coleccionaciones únicas que encarnan la excelencia y que pueden combinarse entre sí**. Jugando con las combinaciones, los contrastes, las formas, los colores y los materiales, cada plato encuentra su lugar en la mesa con armonía, **elegancia y sobriedad**. **Materiales nobles, líneas depuradas**, elija todos los saber hacer de DEGRENNE a la hora de preparar su mesa.

**L FRAGMENT**  
227847 - ASSIETTE GOURMET  
DESSERT/SALAD/APP.PLATE W/WIDE RIM - PLATO REDONDO

**BAHIA**  
230910 - BOL COCOTTE - ROUND CASSEROLE  
BOL COCOTTE

P.36

P.68





MADE IN FRANCE

---

## PORCELAINE DE LIMOGES ET EXCELLENCE

---

Allez élégance et sobriété grâce à des matières nobles et des formes aux lignes épurées. **D'une blancheur et d'une opalescence remarquables, la Porcelaine de Limoges est symbole d'excellence et de pureté.**

---

### LIMOGES PORCELAIN AND EXCELLENCE

---

Combine elegance and simplicity by harnessing the finest materials and sleek lines. **Stunning white and milky iridescent Limoges porcelain is the epitome of excellence and purity.**

---

### PORCELANA DE LIMOGES Y EXCELENCIA

---

Conjuga elegancia y sobriedad gracias a materiales nobles y formas con líneas depuradas. **De una blancura y una opalescencia destacables, la porcelana de Limoges es símbolo de excelencia y de pureza.**



**NEW** COLLECTION L  
**COUTURE**

Haute Porcelaine de Limoges  
High Limoges Porcelain - Porcelana de Limoges



237398  
**ASSIETTE DE PRÉSENTATION**  
ROUND PRESENTATION PLATE  
W/WIDE RIM  
PLATO PRESENTACIÓN REDONDO  
EXT : 32 CM - 12 IN<sup>5/8</sup>  
INT : 19,5 CM - 7 IN<sup>11/16</sup>

237399  
**ASSIETTE PLATE**  
ROUND DINNER PLATE  
W/WIDE RIM  
PLATO REDONDO  
EXT : 28 CM - 11 IN  
INT : 17 CM - 6 IN<sup>11/16</sup>

237400  
**ASSIETTE DESSERT**  
ROUND DESSERT/SALAD/  
APP.PLATE W/WIDE RIM  
PLATO REDONDO  
EXT : 24 CM - 9 IN<sup>7/16</sup>  
INT : 15 CM - 5 IN<sup>7/8</sup>

237401  
**ASSIETTE À PAIN**  
ROUND BREAD & BUTTER  
PLATE W/WIDE RIM  
PLATO DE PAN REDONDO  
EXT : 14 CM - 5 IN<sup>1/2</sup>  
INT : 9,5 CM - 3 IN<sup>3/4</sup>

COMPATIBLE AVEC LES ASSIETTES COCOTTE P. 68-69  
COMPATIBLE WITH THE CASSEROLE PLATES P. 68-69  
COMPATIBLE CON LOS PLATOS COCOTTE P. 68-69



237402  
**ASSIETTE GOURMET**  
ROUND SHALLOW BOWL W/WIDE RIM  
PLATO GOURMET  
EXT : 30 CM - 11 IN<sup>13/16</sup>  
INT : 14 CM - 5 IN<sup>1/2</sup>

COMPATIBLE AVEC LES BOLS COCOTTE P. 68-69  
COMPATIBLE WITH THE ROUND CASSEROLES P. 68-69  
COMPATIBLE CON LOS BOLES COCOTTE P. 68-69



237403  
**ASSIETTE GOURMET**  
ROUND SHALLOW BOWL W/WIDE RIM  
PLATO GOURMET  
EXT : 28 CM - 11 IN  
INT : 11,5 CM - 4 IN<sup>1/2</sup>

COMPATIBLE AVEC LES BOLS BISEAUTÉS COCOTTE P.68-69  
COMPATIBLE WITH THE SLANTED RIM BOWLS P. 68-69  
COMPATIBLE CON LOS BOLES BISEADOS COCOTTE P. 68-69

**PORCELAINE - PORCELAIN - PORCELANA**

**ASSIETTE/COUVERCLE**  
ROUND PLATE/CASSEROLE LID  
BOL/PLATO RONDON PAN  
12,5 CM - 4 IN<sup>15/16</sup>



209383  
**BLANC BRILLANT**  
BRIGHT WHITE  
BLANCO BRILLANTE

209720  
**BLANC SABLÉ**  
SANDY WHITE  
BLANCO PURO

**BOL COCOTTE**  
ROUND CASSEROLE  
BOL COCOTTE  
14 CM - 5 IN<sup>1/2</sup>  
50 CL - 16 OZ<sup>15/16</sup>

**CÉRAMIQUE TEINTÉE MASSE - MASS COLORED CERAMIC**  
CERÁMICA COLORADO A TODA MESA

230820

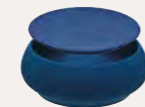

230821  
**BLEU**  
BLUE  
AZUL

204042



204041  
**CARBONE**  
GREY  
GRIS

AUTRES COULEURS  
OTHER COLORS  
OTROS COLORES



**COCOTTES P.68-69**

**PORCELAINE - PORCELAIN - PORCELANA**

**ASSIETTE/COUVERCLE**  
ROUND PLATE/CASSEROLE LID  
BOL/PLATO RONDON PAN  
12,5 CM - 4 IN<sup>15/16</sup>



186849  
**BLANC BRILLANT**  
BRIGHT WHITE  
BLANCO BRILLANTE

211893  
**BLANC SABLÉ**  
SANDY WHITE  
BLANCO PURO

**BOL BISEAUTÉ COCOTTE**  
SLANTED RIM BOWL  
BOL BISEADO COCOTTE  
12 CM - 4 IN<sup>3/4</sup>  
30 CL - 10 OZ<sup>1/16</sup>

**CÉRAMIQUE TEINTÉE MASSE - MASS COLORED CERAMIC**  
CERÁMICA COLORADO A TODA MESA



230822  
**BLEU**  
BLUE  
AZUL



234209  
**CARBONE**  
CARBONE/BLACK  
NEGRO

AUTRES COULEURS  
OTHER COLORS  
OTROS COLORES



**COCOTTES P. 68-69**



182614  
**CLOCHE INOX**  
DOME COVER, STAINLESS STEEL  
CAMPANA  
24 CM - Ø 9 IN<sup>7/16</sup>



182301  
**CLOCHE INOX**  
DOME COVER, STAINLESS STEEL  
CAMPANA  
14,8 CM - Ø 5 IN<sup>13/16</sup>



206504  
**BOUCHON PORCELAINE**  
PORCELAIN LID  
TAPA DE PORCELANA  
5,2 CM - 2 IN<sup>1/16</sup>



227828  
**TASSE ESPRESSO**  
DEMITASSE CUP  
ESPRESSO TAZA  
10 CL - 3 OZ<sup>2/3</sup>



227829  
**TASSE LUNGO**  
COFFEE/TEA CUP  
LUNGO TAZA  
25 CL - 8 OZ<sup>7/16</sup>

204043  
**CLOCHE VERRE BOROSILICATE**  
GLASS DOME COVER  
CAMPANA VIDRIO BOROSILICATO  
17X9 CM - 6 IN<sup>11/16</sup> X 3 IN<sup>5/16</sup>

237404  
**SOUCOUPE ESPRESSO**  
DEMITASSE SAUCER  
ESPRESSO PLATO  
12,6 CM - 4 IN<sup>15/16</sup>

237405  
**SOUCOUPE LUNGO**  
COFFEE/TEA SAUCER  
LUNGO PLATO  
15,8 CM - 6 IN<sup>1/4</sup>



©Patrick ROUGEREAU



# COLLECTION L FRAGMENT

Haute Porcelaine de Limoges  
High Limoges Porcelain - Porcelana de Limoges

MADE IN FRANCE



227843  
**ASSIETTE DE PRÉSENTATION**  
ROUND PRESENTATION PLATE  
W/WIDE RIM  
PLATO PRESENTACIÓN REDONDO  
EXT : 32 CM - 12 IN<sup>5/8</sup>  
INT : 19,5 CM - 7 IN<sup>11/16</sup>

227844  
**ASSIETTE PLATE**  
ROUND DINNER PLATE  
W/WIDE RIM  
PLATO REDONDO  
EXT : 28 CM - 11 IN  
INT : 17 CM - 6 IN<sup>7/8</sup>

227845  
**ASSIETTE DESSERT**  
ROUND DESSERT/SALAD/  
APP.PLATE W/WIDE RIM  
PLATO REDONDO  
EXT : 24 CM - 9 IN<sup>7/16</sup>  
INT : 15 CM - 5 IN<sup>7/8</sup>

227846  
**ASSIETTE À PAIN**  
ROUND BREAD & BUTTER  
PLATE W/WIDE RIM  
PLATO DE PAN REDONDO  
EXT : 14 CM - 5 IN<sup>1/2</sup>  
INT : 9,5 CM - 3 IN<sup>3/4</sup>

COMPATIBLE AVEC LES ASSIETTES COCOTTE P. 68-69  
COMPATIBLE WITH THE CASSEOLE PLATES P. 68-69  
COMPATIBLE CON LOS PLATOS COCOTTE P. 68-69



227847  
**ASSIETTE GOURMET**  
ROUND SHALLOW BOWL W/WIDE RIM  
PLATO GOURMET  
EXT : 30 CM - 11 IN<sup>5/8</sup>  
INT : 14 CM - 5 IN<sup>1/2</sup>

COMPATIBLE AVEC LES BOLS COCOTTE P. 68-69  
COMPATIBLE WITH THE ROUND CASSEOLES P. 68-69  
COMPATIBLE CON LOS BOLES COCOTTE P. 68-69



227848  
**ASSIETTE GOURMET**  
ROUND SHALLOW BOWL W/WIDE RIM  
PLATO GOURMET  
EXT : 28 CM - 11 IN  
INT : 11,5 CM - 4 IN<sup>1/2</sup>

COMPATIBLE AVEC LES BOLS BISEAUTÉS COCOTTE P.68-69  
COMPATIBLE WITH THE SLANTED RIM BOWLS P. 68-69  
COMPATIBLE CON LOS BOLES BISEADOS COCOTTE P. 68-69

PORCELAINE - PORCELAIN - PORCELANA

**ASSIETTE/COUVERCLE**  
ROUND PLATE/CASSEROLE LID  
BOL/PLATO RONDO PAN  
12,5 CM - 4 IN<sup>5/16</sup>

209384



209383  
**BLANC BRILLANT**  
BRIGHT WHITE  
BLANCO BRILLANTE

209384



209720  
**BLANC SABLÉ**  
SANDY WHITE  
BLANCO PURO

**BOL COCOTTE**  
ROUND CASSEOLE  
BOL COCOTTE  
14 CM - 5 IN<sup>1/2</sup>  
50 CL - 16 OZ<sup>5/16</sup>

CÉRAMIQUE TEINTÉE MASSE - MASS COLORED CERAMIC

CERÁMICA COLORADO A TODA MESA

230820

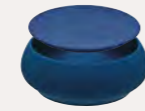

230821  
**BLEU**  
BLUE  
AZUL

204042



204041  
**CARBONE**  
GREY  
GRIS

AUTRES COULEURS  
OTHER COLORS  
OTROS COLORES



COCOTTES P.68-69

PORCELAINE - PORCELAIN - PORCELANA

**ASSIETTE/COUVERCLE**  
ROUND PLATE/CASSEROLE LID  
BOL/PLATO RONDO PAN  
12,5 CM - 4 IN<sup>5/16</sup>



186849  
**BLANC BRILLANT**  
BRIGHT WHITE  
BLANCO BRILLANTE



211893  
**BLANC SABLÉ**  
SANDY WHITE  
BLANCO PURO

**BOL BISEAUTÉ COCOTTE**  
SLANTED RIM BOWL  
BOL BISEADO COCOTTE  
12 CM - 4 IN<sup>3/4</sup>  
30 CL - 10 OZ<sup>5/8</sup>

CÉRAMIQUE TEINTÉE MASSE - MASS COLORED CERAMIC

CERÁMICA COLORADO A TODA MESA



230822  
**BLEU**  
BLUE  
AZUL



234209  
**CARBONE**  
CARBONE/BLACK  
NEGRO

AUTRES COULEURS  
OTHER COLORS  
OTROS COLORES



COCOTTES P. 68-69



182614  
**CLOCHE INOX**  
DOME COVER, STAINLESS STEEL  
CAMPANA  
24 CM - Ø 9 IN<sup>7/16</sup>



182301  
**CLOCHE INOX**  
DOME COVER, STAINLESS STEEL  
CAMPANA  
14,8 CM - Ø 5 IN<sup>13/16</sup>



206504  
**BOUCHON PORCELAINE**  
PORCELAIN LID  
TAPA DE PORCELANA  
5,2 CM - 2 IN<sup>1/16</sup>



227828  
**TASSE ESPRESSO**  
DEMITASSE CUP  
ESPRESSO TAZA  
10 CL - 3 OZ<sup>2/8</sup>



227829  
**TASSE LUNGO**  
COFFEE/TEA CUP  
LUNGO TAZA  
25 CL - 8 OZ<sup>7/16</sup>

204043  
**CLOCHE VERRE BOROSILICATE**  
GLASS DOME COVER  
CAMPANA VIDRIO BOROSILICATO  
17X9 CM - 6 IN<sup>11/16</sup> X 3 IN<sup>5/16</sup>

227849  
**SOUCOUPE ESPRESSO**  
DEMITASSE SAUCER  
ESPRESSO PLATO  
12,6 CM - 4 IN<sup>15/16</sup>

227850  
**SOUCOUPE LUNGO**  
COFFEE/TEA SAUCER  
LUNGO PLATO  
15,8 CM - 6 IN<sup>1/4</sup>



©Thuries Gastronomie Magazine - Pascal Lattes



# COLLECTION L PERLES DE ROSÉE

Haute Porcelaine de Limoges  
High Limoges Porcelain - Porcelana de Limoges

MADE IN FRANCE



233922  
**ASSIETTE DE PRÉSENTATION**  
ROUND PRESENTATION PLATE  
W/WIDE RIM  
PLATO PRESENTACIÓN REDONDO  
EXT : 32 CM - 12 IN<sup>5/8</sup>  
INT : 19,5 CM - 7 IN<sup>11/16</sup>

233923  
**ASSIETTE PLATE**  
ROUND DINNER PLATE  
W/WIDE RIM  
PLATO REDONDO  
EXT : 28 CM - 11 IN  
INT : 17 CM - 6 IN<sup>11/16</sup>

233924  
**ASSIETTE DESSERT**  
ROUND DESSERT/SALAD/  
APP.PLATE W/WIDE RIM  
PLATO REDONDO  
EXT : 24 CM - 9 IN<sup>7/16</sup>  
INT : 15 CM - 5 IN<sup>7/8</sup>

233925  
**ASSIETTE À PAIN**  
ROUND BREAD & BUTTER  
PLATE W/WIDE RIM  
PLATO DE PAN REDONDO  
EXT : 14 CM - 5 IN<sup>1/2</sup>  
INT : 9,5 CM - 3 IN<sup>3/4</sup>

COMPATIBLE AVEC LES ASSIETTES COCOTTE P. 68-69  
COMPATIBLE WITH THE CASSEROLE PLATES P. 68-69  
COMPATIBLE CON LOS PLATOS COCOTTE P. 68-69



233926  
**ASSIETTE GOURMET**  
ROUND SHALLOW BOWL W/WIDE RIM  
PLATO GOURMET  
EXT : 30 CM - 11 IN<sup>13/16</sup>  
INT : 14 CM - 5 IN<sup>1/2</sup>

COMPATIBLE AVEC LES BOLS COCOTTE P. 68-69  
COMPATIBLE WITH THE ROUND CASSEROLES P. 68-69  
COMPATIBLE CON LOS BOLES COCOTTE P. 68-69

PORCELAINE - PORCELAIN - PORCELANA

**ASSIETTE/COUVERCLE**  
ROUND PLATE/CASSEROLE LID  
BOL/PLATO RONDO PAN  
12,5 CM - 4 IN<sup>15/16</sup>

209384



209383  
**BLANC BRILLANT**  
BRIGHT WHITE  
BLANCO BRILLANTE

209384



209720  
**BLANC SABLÉ**  
SANDY WHITE  
BLANCO PURO

**BOL COCOTTE**  
ROUND CASSEROLE  
BOL COCOTTE  
14 CM - 5 IN<sup>1/2</sup>  
50 CL - 16 OZ<sup>15/16</sup>

CÉRAMIQUE TEINTÉE MASSE - MASS COLORED CERAMIC  
CERÁMICA COLORADO A TODA MESA

AUTRES COULEURS  
OTHER COLORS  
OTROS COLORES

230820

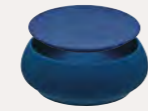

230821  
**BLEU**  
BLUE  
AZUL

204042



204041  
**CARBONE**  
GREY  
GRIS

**COCOTTES P.68-69**

PORCELAINE - PORCELAIN - PORCELANA

**ASSIETTE/COUVERCLE**  
ROUND PLATE/CASSEROLE LID  
BOL/PLATO RONDO PAN  
12,5 CM - 4 IN<sup>15/16</sup>



186849  
**BLANC BRILLANT**  
BRIGHT WHITE  
BLANCO BRILLANTE



211893  
**BLANC SABLÉ**  
SANDY WHITE  
BLANCO PURO

**BOL BISEAUTÉ COCOTTE**  
SLANTED RIM BOWL  
BOL BISEADO COCOTTE  
12 CM - 4 IN<sup>3/4</sup>  
30 CL - 10 OZ<sup>1/8</sup>

CÉRAMIQUE TEINTÉE MASSE - MASS COLORED CERAMIC  
CERÁMICA COLORADO A TODA MESA

AUTRES COULEURS  
OTHER COLORS  
OTROS COLORES



230822  
**BLEU**  
BLUE  
AZUL



234209  
**CARBONE**  
CARBONE/BLACK  
NEGRO

**COCOTTES P. 68-69**



182614  
**CLOCHE INOX**  
DOME COVER, STAINLESS STEEL  
CAMPANA  
24 CM - Ø 9 IN<sup>7/16</sup>



182301  
**CLOCHE INOX**  
DOME COVER, STAINLESS STEEL  
CAMPANA  
14,8 CM - Ø 5 IN<sup>13/16</sup>



206504  
**BOUCHON PORCELAINE**  
PORCELAIN LID  
TAPA DE PORCELANA  
5,2 CM - 2 IN<sup>1/16</sup>



227828  
**TASSE ESPRESSO**  
DEMITASSE CUP  
ESPRESSO TAZA  
10 CL - 3 OZ<sup>2/8</sup>



227829  
**TASSE LUNGO**  
COFFEE/TEA CUP  
LUNGO TAZA  
25 CL - 8 OZ<sup>7/16</sup>

204043  
**CLOCHE VERRE BOROSILICATE**  
GLASS DOME COVER  
CAMPANA VIDRIO BOROSILICATO  
17X9 CM - 6 IN<sup>11/16</sup> X 3 IN<sup>15/16</sup>

233928  
**SOUCOUPE ESPRESSO**  
DEMITASSE SAUCER  
ESPRESSO PLATO  
12,6 CM - 4 IN<sup>15/16</sup>

233929  
**SOUCOUPE LUNGO**  
COFFEE/TEA SAUCER  
LUNGO PLATO  
15,8 CM - 6 IN<sup>1/4</sup>



©Patrick ROUGEREAU



# COLLECTION L

Haute Porcelaine de Limoges  
High Limoges Porcelain - Porcelana de Limoges

MADE IN FRANCE



227822  
**ASSIETTE DE PRÉSENTATION**  
ROUND PRESENTATION PLATE  
W/WIDE RIM  
PLATO PRESENTACIÓN REDONDO  
EXT : 32 CM - 12 IN<sup>13/16</sup>  
INT : 19,5 CM - 7 IN<sup>11/16</sup>

227823  
**ASSIETTE PLATE**  
ROUND DINNER PLATE  
W/WIDE RIM  
PLATO REDONDO  
EXT : 28 CM - 11 IN  
INT : 17 CM - 6 IN<sup>11/16</sup>

227824  
**ASSIETTE DESSERT**  
ROUND DESSERT/SALAD/  
APP.PLATE W/WIDE RIM  
PLATO REDONDO  
EXT : 24 CM - 9 IN<sup>7/16</sup>  
INT : 15 CM - 5 IN<sup>7/8</sup>

232576  
**ASSIETTE CREUSE CALOTTE**  
ROUND CEREAL PLATE  
PLATO HONDO  
EXT : 18,5 CM - 7 IN<sup>5/16</sup>

227825  
**ASSIETTE À PAIN**  
ROUND BREAD & BUTTER  
PLATE W/WIDE RIM  
PLATO DE PAN REDONDO  
EXT : 14 CM - 5 IN<sup>1/2</sup>  
INT : 9,5 CM - 3 IN<sup>3/4</sup>

COMPATIBLE AVEC LES ASSIETTES COCOTTE P. 68-69  
COMPATIBLE WITH THE CASSEROLE PLATES P. 68-69  
COMPATIBLE CON LOS PLATOS COCOTTE P. 68-69



227826  
**ASSIETTE GOURMET**  
ROUND SHALLOW BOWL W/WIDE RIM  
PLATO GOURMET  
EXT : 30 CM - 11 IN<sup>13/16</sup>  
INT : 14 CM - 5 IN<sup>1/2</sup>

COMPATIBLE AVEC LES BOLS COCOTTE P. 68-69  
COMPATIBLE WITH THE ROUND CASSEROLES P. 68-69  
COMPATIBLE CON LOS BOLES COCOTTE P. 68-69

PORCELAINE - PORCELAIN - PORCELANA

**ASSIETTE/COUVERCLE**  
ROUND PLATE/CASSEROLE LID  
BOL/PLATO RONDO PAN  
12,5 CM - 4 IN<sup>15/16</sup>

209384



209383  
**BLANC BRILLANT**  
BRIGHT WHITE  
BLANCO BRILLANTE

209384



209720  
**BLANC SABLÉ**  
SANDY WHITE  
BLANCO PURO

**BOL COCOTTE**  
ROUND CASSEROLE  
BOL COCOTTE  
14 CM - 5 IN<sup>1/2</sup>  
50 CL - 16 OZ<sup>1/16</sup>

CÉRAMIQUE TEINTÉE MASSE - MASS COLORED CERAMIC  
CERÁMICA COLORADO A TODA MESA

230820

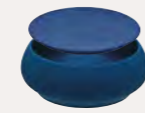

230821  
**BLEU**  
BLUE  
AZUL

204042



204041  
**CARBONE**  
GREY  
GRIS

AUTRES COULEURS  
OTHER COLORS  
OTROS COLORES



COCOTTES P.68-69

PORCELAINE - PORCELAIN - PORCELANA

**ASSIETTE/COUVERCLE**  
ROUND PLATE/CASSEROLE LID  
BOL/PLATO RONDO PAN  
12,5 CM - 4 IN<sup>15/16</sup>

186849



186849  
**BLANC BRILLANT**  
BRIGHT WHITE  
BLANCO BRILLANTE

211893



211893  
**BLANC SABLÉ**  
SANDY WHITE  
BLANCO PURO

**BOL BISEAUTÉ COCOTTE**  
SLANTED RIM BOWL  
BOL BISEADO COCOTTE  
12 CM - 4 IN<sup>3/4</sup>  
30 CL - 10 OZ<sup>1/8</sup>

CÉRAMIQUE TEINTÉE MASSE - MASS COLORED CERAMIC  
CERÁMICA COLORADO A TODA MESA

230822

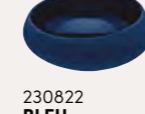

230822  
**BLEU**  
BLUE  
AZUL

234209

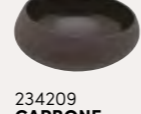

234209  
**CARBONE**  
CARBONE/BLACK  
NEGRO

AUTRES COULEURS  
OTHER COLORS  
OTROS COLORES



COCOTTES P. 68-69



227827  
**ASSIETTE GOURMET**  
ROUND SHALLOW BOWL W/WIDE RIM  
PLATO GOURMET  
EXT : 28 CM - 11 IN  
INT : 14,5 CM - 4 IN<sup>1/2</sup>

COMPATIBLE AVEC LES BOLS BISEAUTÉS COCOTTE P.68-69  
COMPATIBLE WITH THE SLANTED RIM BOWLS P. 68-69  
COMPATIBLE CON LOS BOLES BISEADOS COCOTTE P. 68-69



182614  
**CLOCHE INOX**  
DOME COVER, STAINLESS STEEL  
CAMPANA  
24 CM - Ø 9 IN<sup>7/16</sup>

182301  
**CLOCHE INOX**  
DOME COVER, STAINLESS STEEL  
CAMPANA  
14,8 CM - Ø 5 IN<sup>13/16</sup>

206504  
**BOUCHON PORCELAINE**  
PORCELAIN LID  
TAPA DE PORCELANA  
5,2 CM - 2 IN<sup>1/16</sup>

227828  
**TASSE ESPRESSO**  
DEMITASSE CUP  
ESPRESSO TAZA  
10 CL - 3 OZ<sup>2/8</sup>

227829  
**TASSE LUNGO**  
COFFEE/TEA CUP  
LUNGO TAZA  
25 CL - 8 OZ<sup>7/16</sup>

204043  
**CLOCHE VERRE BOROSILICATE**  
GLASS DOME COVER  
CAMPANA VIDRIO BOROSILICATO  
17X9 CM - 6 IN<sup>11/16</sup> X 3 IN<sup>5/16</sup>

227831  
**SOUCOUPE ESPRESSO**  
DEMITASSE SAUCER  
ESPRESSO PLATO  
12,6 CM - 4 IN<sup>15/16</sup>

227832  
**SOUCOUPE LUNGO**  
COFFEE/TEA SAUCER  
LUNGO PLATO  
15,8 CM - 6 IN<sup>1/4</sup>





213936  
**ASSIETTE DE PRÉSENTATION**  
 ROUND PRESENTATION PLATE  
 W/WIDE RIM  
 PLATO PRESENTACIÓN REDONDO  
 EXT : 32 CM - 12 IN<sup>5/8</sup>  
 INT : 20 CM - 7 IN<sup>7/8</sup>

213938  
**ASSIETTE PLATE**  
 ROUND DINNER PLATE  
 W/WIDE RIM  
 PLATO REDONDO  
 EXT : 28 CM - 11 IN  
 INT : 17 CM - 6 IN<sup>11/16</sup>

213940  
**ASSIETTE DESSERT**  
 ROUND DESSERT/SALAD/  
 APP.PLATE W/WIDE RIM  
 PLATO REDONDO  
 EXT : 24 CM - 9 IN<sup>7/16</sup>  
 INT : 15 CM - 5 IN<sup>7/8</sup>

213942  
**ASSIETTE À PAIN**  
 ROUND BREAD & BUTTER  
 PLATE W/WIDE RIM  
 PLATO DE PAN REDONDO  
 EXT : 14 CM - 5 IN<sup>1/2</sup>  
 INT : 9,5 CM - 3 IN<sup>3/4</sup>

COMPATIBLE AVEC LES ASSIETTES COCOTTE P. 68-69  
 COMPATIBLE WITH THE CASSEOLE PLATES P. 68-69  
 COMPATIBLE CON LOS PLATOS COCOTTE P. 68-69



222366  
**ASSIETTE GOURMET**  
 ROUND SHALLOW BOWL W/WIDE RIM  
 PLATO GOURMET  
 EXT : 30 CM - 11 IN<sup>13/16</sup>  
 INT : 14 CM - 5 IN<sup>1/2</sup>

COMPATIBLE AVEC LES BOLS COCOTTE P. 68-69  
 COMPATIBLE WITH THE ROUND CASSEOLE P. 68-69  
 COMPATIBLE CON LOS BOLES COCOTTE P. 68-69



222365  
**ASSIETTE GOURMET**  
 ROUND SHALLOW BOWL W/WIDE RIM  
 PLATO GOURMET  
 EXT : 28 CM - 11 IN  
 INT : 12 CM - 4 IN<sup>3/4</sup>

COMPATIBLE AVEC LES BOLS BISEAUTÉS COCOTTE P.68-69  
 COMPATIBLE WITH THE SLANTED RIM BOWLS P. 68-69  
 COMPATIBLE CON LOS BOLES BISEADOS COCOTTE P. 68-69

**PORCELAINE - PORCELAIN - PORCELANA**

**ASSIETTE/COUVERCLE**

ROUND PLATE/CASSEOLE LID  
 BOL/PLATO RONDO PAN  
 12,5 CM - 4 IN<sup>15/16</sup>



209383  
**BLANC BRILLANT**  
 BRIGHT WHITE  
 BLANCO BRILLANTE

209720  
**BLANC SABLÉ**  
 SANDY WHITE  
 BLANCO PURO

**BOL COCOTTE**  
 ROUND CASSEOLE  
 BOL COCOTTE  
 14 CM - 5 IN<sup>1/2</sup>  
 50 CL - 16 OZ<sup>15/16</sup>

**CÉRAMIQUE TEINTÉE MASSE - MASS COLORED CERAMIC**

**CÉRÂMICA COLORADO A TODA MESA**

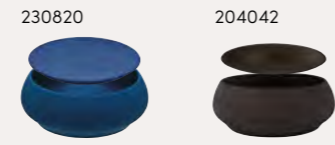

230820  
**BLEU**  
 BLUE  
 AZUL

204041  
**CARBONE**  
 GREY  
 GRIS



AUTRES COULEURS  
 OTHER COLORS  
 OTROS COLORES  
**COCOTTES P.68-69**

**PORCELAINE - PORCELAIN - PORCELANA**

**ASSIETTE/COUVERCLE**

ROUND PLATE/CASSEOLE LID  
 BOL/PLATO RONDO PAN  
 12,5 CM - 4 IN<sup>15/16</sup>



186849  
**BLANC BRILLANT**  
 BRIGHT WHITE  
 BLANCO BRILLANTE

211893  
**BLANC SABLÉ**  
 SANDY WHITE  
 BLANCO PURO

**BOL BISEAUTÉ COCOTTE**  
 SLANTED RIM BOWL  
 BOL BISEADO COCOTTE  
 12 CM - 4 IN<sup>3/4</sup>  
 30 CL - 10 OZ<sup>15/16</sup>

**CÉRAMIQUE TEINTÉE MASSE - MASS COLORED CERAMIC**

**CÉRÂMICA COLORADO A TODA MESA**



230822  
**BLEU**  
 BLUE  
 AZUL

234209  
**CARBONE**  
 CARBONE/BLACK  
 NEGRO



AUTRES COULEURS  
 OTHER COLORS  
 OTROS COLORES  
**COCOTTES P. 68-69**



182614  
**CLOCHE INOX**  
 DOME COVER, STAINLESS STEEL  
 CAMPANA  
 24 CM - Ø 9 IN<sup>7/16</sup>

182301  
**CLOCHE INOX**  
 DOME COVER, STAINLESS STEEL  
 CAMPANA  
 14,8 CM - Ø 5 IN<sup>13/16</sup>



206504  
**BOUCHON PORCELAINE**  
 PORCELAIN LID  
 TAPA DE PORCELANA  
 5,2 CM - 2 IN<sup>1/16</sup>  
 204043  
**CLOCHE VERRE BOROSILICATE**  
 GLASS DOME COVER  
 CAMPANA VIDRIO BOROSILICATO  
 17X9 CM - 6 IN<sup>11/16</sup> X 3 IN<sup>15/16</sup>



207756  
**TASSE ESPRESSO**  
 DEMITASSE CUP  
 ESPRESSO TAZA  
 10 CL - 3 OZ<sup>2/3</sup>



207757  
**TASSE LUNGO**  
 COFFEE/TEA CUP  
 LUNGO TAZA  
 20 CL - 6 OZ<sup>3/4</sup>

223406  
**SOUCOUBE ESPRESSO**  
 DEMITASSE SAUCER  
 ESPRESSO PLATO  
 12,6 CM - 4 IN<sup>15/16</sup>

223407  
**SOUCOUBE LUNGO**  
 COFFEE/TEA SAUCER  
 LUNGO PLATO  
 15 CM - 5 IN<sup>7/8</sup>



©Patrick ROUGEREAU





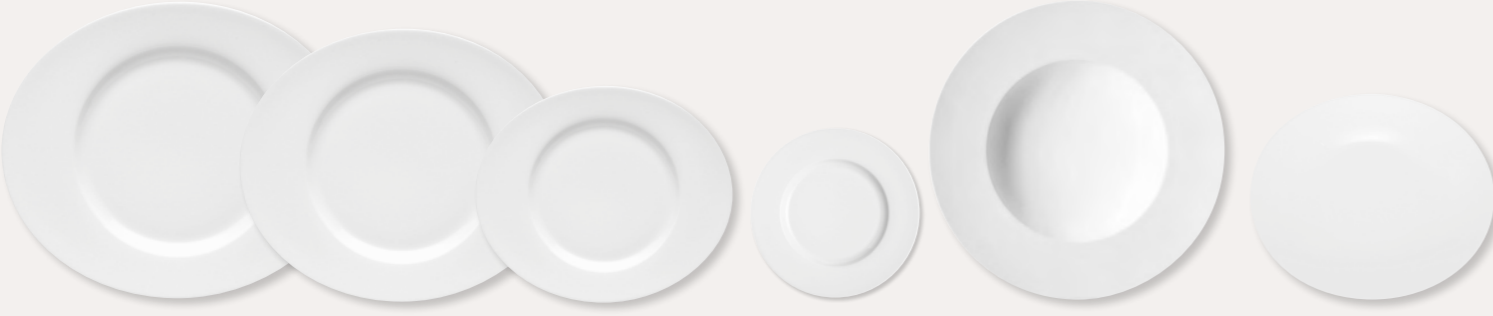

- |  |   |  |  |   |  |
|--|---|--|--|---|--|
| <p>207137<br/> <b>ASSIETTE DE PRÉSENTATION</b><br/>                 OVAL PRESENTATION PLATE<br/>                 W/WIDE RIM<br/>                 PLATO PRESENTACIÓN OVAL<br/>                 EXT : 34,5 X 29 CM - 13 IN<sup>3/8</sup> X 11 IN<sup>7/8</sup><br/>                 INT : 20,5 CM - 8 IN<sup>1/8</sup></p> | <p>207134<br/> <b>ASSIETTE PLATE</b><br/>                 OVAL DINNER PLATE<br/>                 W/WIDE RIM<br/>                 PLATO OVAL<br/>                 EXT : 31 X 26,5 CM - 12 IN<sup>3/8</sup> X 10 IN<sup>7/8</sup><br/>                 INT : 18 CM - 7 IN<sup>1/8</sup></p> | <p>207135<br/> <b>ASSIETTE DESSERT</b><br/>                 OVAL DESSERT PLATE<br/>                 W/WIDE RIM<br/>                 PLATO OVAL<br/>                 EXT : 24 X 20,5 CM - 9 IN<sup>7/8</sup> X 8 IN<sup>5/8</sup><br/>                 INT : 14,5 CM - 5 IN<sup>5/8</sup></p> | <p>207139<br/> <b>ASSIETTE À PAIN</b><br/>                 ROUND BREAD &amp;<br/>                 BUTTER PLATE<br/>                 PLATO DE PAN REDONDO<br/>                 EXT : 16 CM - 6 IN<sup>5/8</sup><br/>                 INT : 10 CM - 3 IN<sup>5/8</sup></p> | <p>207140<br/> <b>ASSIETTE À PÂTES/SOUBE</b><br/>                 ROUND SOUP/PASTA BOWL<br/>                 W/WIDE RIM<br/>                 PLATO HONDO PASTA REDONDO<br/>                 EXT : 29,5 CM - 11 IN<sup>5/8</sup><br/>                 INT : 17 CM - 6 IN<sup>1/8</sup></p> | <p>207136<br/> <b>ASSIETTE CALOTTE OVALE</b><br/>                 OVAL SHALLOW BOWL, COUPE<br/>                 PLATO HONDO OVAL<br/>                 EXT : 23,5 X 20 CM - 9 IN<sup>1/4</sup> X 7 IN<sup>7/8</sup></p> |
|--|---|--|--|---|--|



204040  
**ASSIETTE GOURMET OVALE GRAND BASSIN**  
 SHALLOW BOWL W/WIDE OVAL RIM  
 PLATO GOURMET OVAL FONDO GRANDE  
 EXT : 32 X 27 CM - 12 IN<sup>5/8</sup> X 10 IN<sup>5/8</sup>  
 INT : 14,5 CM - 5 IN<sup>5/8</sup>  
 27 CL - 9 OZ<sup>1/8</sup>



207141  
**ASSIETTE GOURMET OVALE BASSIN PLAT**  
 OVAL PLATE W/WIDE - RIM, FLAT  
 PLATO GOURMET OVAL  
 EXT : 30 X 26 CM - 11 IN<sup>3/8</sup> X 10 IN<sup>1/4</sup>  
 INT : 12 CM - 4 IN<sup>3/4</sup>  
**COMPATIBLE AVEC LES BOLS COCOTTE P. 68-69**  
 COMPATIBLE WITH THE ROUND CASSEROLES P. 68-69  
 COMPATIBLE CON LOS BOLES COCOTTE P. 68-69



207138  
**ASSIETTE GOURMET OVALE PETIT BASSIN**  
 SHALLOW BOWL W/WIDE OVAL RIM  
 PLATO GOURMET OVAL PEQUEÑO  
 EXT : 30 X 26 CM - 11 IN<sup>3/8</sup> X 10 IN<sup>1/4</sup>  
 INT : 13,5 CM - 5 IN<sup>5/8</sup>  
 17 CL - 5 OZ<sup>3/4</sup>  
**COMPATIBLE AVEC LES BOLS BISEAUTÉS COCOTTE P. 68-69**  
 COMPATIBLE WITH THE SLANTED RIM BOWLS P. 68-69  
 COMPATIBLE CON LOS BOLES BISEADOS COCOTTE P. 68-69



182614  
**CLOCHE INOX**  
 DOME COVER, STAINLESS STEEL  
 CAMPANA  
 24 CM - Ø 9 IN<sup>7/8</sup>



182301  
**CLOCHE INOX**  
 DOME COVER, STAINLESS STEEL  
 CAMPANA  
 14,8 CM - Ø 5 IN<sup>13/16</sup>



206504  
**BOUCHON PORCELAINE**  
 PORCELAIN LID  
 TAPA DE PORCELANA  
 5,2 CM - 2 IN<sup>1/8</sup>  
 204043  
**CLOCHE VERRE BOROSILICATE**  
 GLASS DOME COVER  
 CAMPANA VIDRIO BOROSILICATO  
 17X9 CM - 6 IN<sup>11/16</sup> X 3 IN<sup>9/16</sup>

**PORCELAINE - PORCELAIN - PORCELANA**  
**ASSIETTE/COUVERCLE**  
 ROUND PLATE/CASSEROLE LID  
 BOL/PLATO RONDO PAN  
 12,5 CM - 4 IN<sup>5/8</sup>

<p>209384</p>  <p>209383  <b>BLANC BRILLANT</b>                  BRIGHT WHITE                  BLANCO BRILLANTE</p>	<p>209384</p>  <p>209720  <b>BLANC SABLÉ</b>                  SANDY WHITE                  BLANCO PURO</p>
--	---

**BOL COCOTTE**  
 ROUND CASSEROLE  
 BOL COCOTTE  
 14 CM - 5 IN<sup>1/2</sup>  
 50 CL - 16 OZ<sup>5/8</sup>

---

**CÉRAMIQUE TEINTÉE MASSE - MASS COLORED CERAMIC**  
 CERÁMICA COLORADO A TODA MESA

<p>230820</p>  <p>230821  <b>BLEU</b>                  BLUE                  AZUL</p>	<p>204042</p>  <p>204041  <b>CARBONE</b>                  GREY                  GRIS</p>	<p>AUTRES COULEURS                  OTHER COLORS                  OTROS COLORES</p>  <p><b>COCOTTES P.68-69</b></p>
---	---	--

**PORCELAINE - PORCELAIN - PORCELANA**

<p>186849</p>  <p>186849  <b>BLANC BRILLANT</b>                  BRIGHT WHITE                  BLANCO BRILLANTE</p>	<p>211893</p>  <p>211893  <b>BLANC SABLÉ</b>                  SANDY WHITE                  BLANCO PURO</p>
--	---

**BOL BISEAUTÉ COCOTTE**  
 SLANTED RIM BOWL  
 BOL BISEADO COCOTTE  
 12 CM - 4 IN<sup>3/4</sup>  
 30 CL - 10 OZ<sup>1/8</sup>

---

**CÉRAMIQUE TEINTÉE MASSE - MASS COLORED CERAMIC**  
 CERÁMICA COLORADO A TODA MESA

<p>230822</p>  <p>230822  <b>BLEU</b>                  BLUE                  AZUL</p>	<p>234209</p>  <p>234209  <b>CARBONE</b>                  CARBONE/BLACK                  NEGRO</p>	<p>AUTRES COULEURS                  OTHER COLORS                  OTROS COLORES</p>  <p><b>COCOTTES P.68-69</b></p>
---	---	--



©Julie ANSIAU





186782  
**SALADIER**  
SALAD BOWL DEEP  
ENSALADERA  
28 X 24 CM - 11 IN X 9 IN<sup>7/16</sup>  
H : 11 CM - 4 IN<sup>5/16</sup>



186779  
**COUPELLE**  
DEEP BOWL, SMALL  
BOL  
14 X 12 CM - 5 IN<sup>1/2</sup> X 4 IN<sup>3/4</sup>  
H : 5 CM - 4 IN<sup>5/16</sup>



186797  
**VERRINE**  
RAMEKIN  
VASO  
6 CL - 2 OZ  
H : 5,5 CM - 2 IN<sup>3/16</sup>



186851  
**VERRINE**  
RAMEKIN  
VASO  
12 CL - 4 OZ<sup>1/16</sup>  
H : 7 CM - 2 IN<sup>3/4</sup>

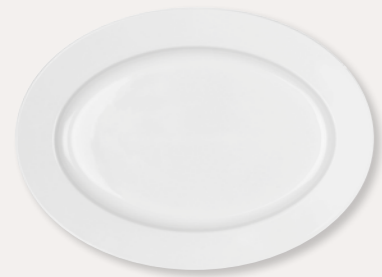

200102  
**PLAT OVAL CREUX**  
OVAL CHOP PLATE W/RIM, FLAT  
PLATO HONDO OVOLADO  
EXT : 36,5 X 26,5 CM - 14 IN<sup>3/8</sup> X 10 IN<sup>7/16</sup>  
INT : 26 X 17 CM - 10 IN<sup>1/4</sup> X 6 IN<sup>11/16</sup>



186788  
**PLAT À CAKE**  
OVAL LONG DISH W/WIDE RIM, FLAT  
FUENTE OVOLADO  
EXT : 40,5 X 19 CM - 15 IN<sup>15/16</sup> X 7 IN<sup>1/2</sup>

**NEWPORT CAFÉTERIE - TEATIME - TÉ CAFÉ**



207756  
**TASSE ESPRESSO**  
DEMITASSE CUP  
ESPRESSO TAZA  
10 CL - 3 OZ<sup>3/8</sup>



207757  
**TASSE LUNGO**  
COFFEE/TEA CUP  
LUNGO TAZA  
20 CL - 6 OZ<sup>3/4</sup>



207758  
**TASSE DÉJEUNER**  
BREAKFAST CUP  
TAZA DESAYUNO  
40 CL - 13 OZ<sup>1/2</sup>

207759  
**SOUCOUBE ESPRESSO**  
DEMITASSE SAUCER  
ESPRESSO PLATO  
12,5 CM - 4 IN<sup>5/16</sup>

207760  
**SOUCOUBE LUNGO**  
COFFEE/TEA SAUCER  
LUNGO PLATO  
15,8 CM - 5 IN<sup>7/8</sup>

207761  
**SOUCOUBE DÉJEUNER**  
BREAKFAST SAUCER  
PLATO DESAYUNO  
18 CM - 7 IN<sup>7/16</sup>



207763  
**VERSEUSE**  
COFFEE/TEA POT  
CAFETERA/TETERA  
40 CL - 13 OZ<sup>1/2</sup>



207764  
**VERSEUSE**  
COFFEE/TEA POT  
CAFETERA/TETERA  
80 CL - 27 OZ<sup>1/16</sup>



207762  
**CRÉMIER**  
CREAM JUG  
LECHERA  
10 CL - 3 OZ<sup>3/8</sup>



**COUVERCLES VERSEUSES**  
LIDS FOR TEA POTS  
TAPAS CAFETERAS  
210911 210912  
6,6 CM - 2 IN<sup>5/8</sup> 8,4 CM - 3 IN<sup>5/16</sup>  
40 CL - 13 OZ<sup>1/2</sup> 80 CL - 27 OZ<sup>1/16</sup>



©Julie ANSIAU



# BORÉAL SATIN

Porcelaine  
Porcelain - Porcelana



193319  
**ASSIETTE DE PRÉSENTATION**  
ROUND PRESENTATION PLATE  
W/WIDE RIM  
PLATO PRESENTACIÓN REDONDO  
EXT : 33 CM - 13 IN  
INT : 20 CM - 7 IN<sup>7/8</sup>

193318  
**ASSIETTE PLATE**  
ROUND DINNER PLATE  
W/WIDE RIM  
PLATO REDONDO  
EXT : 28,5 CM - 11 IN<sup>1/4</sup>  
INT : 18,5 CM - 7 IN<sup>5/16</sup>

193320  
**ASSIETTE DESSERT**  
ROUND DESSERT/PLATE  
W/WIDE RIM  
PLATO ILANO REDONDO  
EXT : 22,5 CM - 8 IN<sup>7/8</sup>  
INT : 14,5 CM - 5 IN<sup>1/16</sup>



202470  
**ASSIETTE À PAIN**  
ROUND BREAD & BUTTER  
PLATE W/WIDE RIM  
PLATO DE PAN REDONDO  
EXT : 15 CM - 5 IN<sup>7/8</sup>



223954  
**ASSIETTE À PÂTES/SOUBE**  
ROUND SOUP/PASTA BOWL  
W/WIDE RIM  
PLATO HONDO PASTA REDONDO  
EXT : 29 CM - 11 IN<sup>7/16</sup>  
INT : 16 CM - 6 IN<sup>5/16</sup>



207769  
**ASSIETTE GOURMET OVALE GRAND BASSIN**  
SHALLOW BOWL W/WIDE OVAL RIM  
PLATO GOURMET OVAL FONDO GRANDE  
EXT : 32 X 27 CM - 12 IN<sup>5/16</sup> X 10 IN<sup>5/8</sup>  
INT : 14 CM - 5 IN<sup>1/2</sup>  
27 CL - 9 OZ<sup>1/8</sup>  
**COMPATIBLE AVEC LES BOLS COCOTTE P. 68-69**  
COMPATIBLE WITH THE ROUND CASSEROLES P. 68-69  
COMPATIBLE CON LOS BOLES COCOTTE P. 68-69

**PORCELAINE - PORCELAIN - PORCELANA**

**ASSIETTE/COUVERCLE**

ROUND PLATE/CASSEROLE LID  
BOL/PLATO RONDO PAN  
12,5 CM - 4 IN<sup>5/16</sup>

209384



209383  
**BLANC BRILLANT**  
BRIGHT WHITE  
BLANCO BRILLANTE

209384



209720  
**BLANC SABLÉ**  
SANDY WHITE  
BLANCO PURO

**BOL COCOTTE**  
ROUND CASSEROLE  
BOL COCOTTE  
14 CM - 5 IN<sup>1/2</sup>  
50 CL - 16 OZ<sup>15/16</sup>

**CÉRAMIQUE TEINTÉE MASSE - MASS COLORED CERAMIC**

CERÁMICA COLORADO A TODA MESA

230820

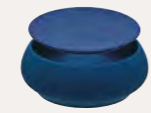

230821  
**BLEU**  
BLUE  
AZUL

204042



204041  
**CARBONE**  
GREY  
GRIS



AUTRES COULEURS  
OTHER COLORS  
OTROS COLORES  
**COCOTTES P.68-69**



193324  
**ASSIETTE GOURMET OVALE PETIT BASSIN**  
SHALLOW BOWL W/WIDE OVAL RIM  
PLATO GOURMET OVAL FONDO PEQUEÑO  
EXT : 30 X 26 CM - 11 IN<sup>13/16</sup> X 10 IN<sup>1/4</sup>  
INT : 12 CM - 4 IN<sup>3/4</sup>  
17 CL - 5 OZ<sup>3/4</sup>  
**COMPATIBLE AVEC LES BOLS BISEAUTÉS COCOTTE P.68-69**  
COMPATIBLE WITH THE SLANTED RIM BOWLS P. 68-69  
COMPATIBLE CON LOS BOLES BISEADOS COCOTTE P. 68-69

**PORCELAINE - PORCELAIN - PORCELANA**

**ASSIETTE/COUVERCLE**

ROUND PLATE/CASSEROLE LID  
BOL/PLATO RONDO PAN  
12,5 CM - 4 IN<sup>5/16</sup>

186849

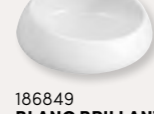

186849  
**BLANC BRILLANT**  
BRIGHT WHITE  
BLANCO BRILLANTE

211893



211893  
**BLANC SABLÉ**  
SANDY WHITE  
BLANCO PURO

**BOL BISEAUTÉ COCOTTE**  
SLANTED RIM BOWL  
BOL BISEADO COCOTTE  
12 CM - 4 IN<sup>3/4</sup>  
30 CL - 10 OZ<sup>1/8</sup>

**CÉRAMIQUE TEINTÉE MASSE - MASS COLORED CERAMIC**

CERÁMICA COLORADO A TODA MESA

230822

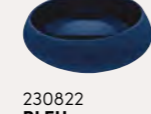

230822  
**BLEU**  
BLUE  
AZUL

234209

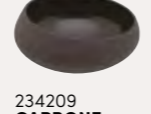

234209  
**CARBONE**  
CARBONE/BLACK  
NEGRO



AUTRES COULEURS  
OTHER COLORS  
OTROS COLORES  
**COCOTTES P.68-69**



182614  
**CLOCHE INOX**  
DOME COVER, STAINLESS STEEL  
CAMPANA  
24 CM - Ø 9 IN<sup>7/16</sup>

182301  
**CLOCHE INOX**  
DOME COVER, STAINLESS STEEL  
CAMPANA  
14,8 CM - Ø 5 IN<sup>13/16</sup>

206504  
**BOUCHON PORCELAINE**  
PORCELAIN LID  
TAPA DE PORCELANA  
5,2 CM - 2 IN<sup>1/16</sup>

204043  
**CLOCHE VERRE BOROSILICATE**  
GLASS DOME COVER  
CAMPANA VIDRIO BOROSILICATO  
17X9 CM - 6 IN<sup>11/16</sup> X 3 IN<sup>5/16</sup>



@Patrick ROUGEREAU



**VERT ARTICHAUT - GREEN ARTICHOKE - VERDE ALCAFOCHA**

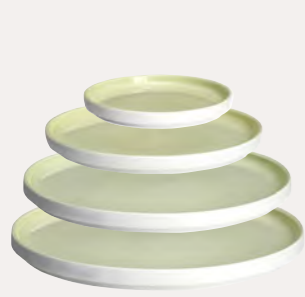

237295  
237296  
237297  
237298



237299  
237300  
237301



237302  
237303



237304

**BLANC NAVET - WHITE TURNIP - BLANCO NABO**



237315  
237316  
237317  
237318



237319  
237320  
237321



237322  
237323



237324

**JAUNE GINGEMBRE - GINGER YELLOW - JENGIBRE AMARILLO**



237285  
237286  
237287  
237288



237289  
237290  
237291



237292  
237293



237294

**ASSIETTE PLATE RONDE**  
ROUND DINNER PLATE  
PLATO REDONDO  
14 CM - 5 IN<sup>1/2</sup>  
18 CM - 7 IN<sup>1/8</sup>  
24 CM - 9 IN<sup>7/8</sup>  
26 CM - 10 IN<sup>1/4</sup>

**BOL DROIT**  
STRAIGHT BOWL  
BOL DERECHO  
14 CM - 5 IN<sup>1/2</sup>  
50 CL - 16 OZ<sup>15/16</sup>  
18 CM - 7 IN<sup>1/8</sup>  
1,3 L - 43 OZ<sup>15/16</sup>  
24 CM - 9 IN<sup>7/8</sup>  
2,6 L - 87 OZ<sup>15/16</sup>

**BOL COUPE**  
FOOTED BOWL  
BOL  
14 CM - 5 IN<sup>1/2</sup>  
47 CL - 15 OZ<sup>7/8</sup>  
18 CM - 7 IN<sup>1/8</sup>  
90 CL - 30 OZ<sup>7/8</sup>

**GRANDE ASSIETTE  
CREUSE RONDE**  
LARGE DEEP PLATE  
GRANDE PLATO HONDO  
24 CM - 9 IN<sup>7/8</sup>  
1,3 L - 43 OZ<sup>15/16</sup>



**RADIS ROSE - PINK RADISH - RÁBANO ROSADO**



237325  
237326  
237327  
237328



237329  
237330  
237331



237332  
237333



237334

**GRIS RUTABAGA - GREY RUTABAGA - COLINABO GRIS**



237305  
237306  
237307  
237308



237309  
237310  
237311



237312  
237313



237314

**ASSIETTE PLATE RONDE**  
ROUND DINNER PLATE  
PLATO REDONDO  
14 CM - 5 IN<sup>1/2</sup>  
18 CM - 7 IN<sup>1/16</sup>  
24 CM - 9 IN<sup>7/16</sup>  
26 CM - 10 IN<sup>1/4</sup>

**BOL DROIT**  
STRAIGHT BOWL  
BOL DERECHO  
14 CM - 5 IN<sup>1/2</sup>  
50 CL - 16 OZ<sup>15/16</sup>  
18 CM - 7 IN<sup>1/16</sup>  
1,3 L - 43 OZ<sup>15/16</sup>  
24 CM - 9 IN<sup>7/16</sup>  
2,6 L - 87 OZ<sup>15/16</sup>

**BOL COUPE**  
FOOTED BOWL  
BOL  
14 CM - 5 IN<sup>1/2</sup>  
47 CL - 15 OZ<sup>7/8</sup>  
18 CM - 7 IN<sup>1/16</sup>  
90 CL - 30 OZ<sup>7/16</sup>

**GRANDE ASSIETTE  
CREUSE RONDE**  
LARGE DEEP PLATE  
GRANDE PLATO HONDO  
24 CM - 9 IN<sup>7/16</sup>  
1,3 L - 43 OZ<sup>15/16</sup>



237337

**CENTRE DE TABLE ROND<sup>(1)</sup>**  
ROUND CENTER DISH  
CENTRO DE MESA  
28 CM - 11 IN

<sup>(1)</sup>NON COMPATIBLE LAVE-VAISSELLE ET MICRO-ONDES  
DONT USE WITH DISH WASHER AND MICRO-WAVE  
NO VA EN EL LAVA-VAJILLAS AND EL MICRO-ONDAS





161009  
**ASSIETTE PLATE**  
PRESENTATION PLATE  
PLATO PRESENTACION  
EXT : 28 CM - 11 IN  
INT : 21 CM - 8 IN<sup>1/4</sup>

161008  
**ASSIETTE PLATE**  
DINNER PLATE  
PLATO REDONDO  
EXT : 24 CM - 9 IN<sup>7/16</sup>  
INT : 18 CM - 7 IN<sup>1/16</sup>



161038  
**ASSIETTE À PAIN**  
ROUND BREAD & BUTTER PLATE  
PLATO DE PAN REDONDO  
EXT : 16 CM - 6 IN<sup>5/16</sup>  
INT : 13 CM - 5 IN<sup>1/8</sup>



161012  
**ASSIETTE CREUSE**  
SHALLOW COUPE BOWL, LARGE  
PLATO HONDO  
EXT : 30 CM - 11 IN<sup>13/16</sup>  
INT : 26 CM - 10 IN<sup>1/4</sup>

161011  
**ASSIETTE CREUSE**  
SHALLOW COUPE BOWL, MEDIUM  
PLATO HONDO  
EXT : 23 CM - 9 IN<sup>1/16</sup>  
INT : 20 CM - 7 IN<sup>7/8</sup>



161016  
**SALADIER**  
DEEP BOWL, LARGE  
ENSALADERA  
32 CM - 12 IN<sup>5/8</sup>  
CONTENANCE : 250 CL  
CAPACITY : 84 OZ<sup>3/16</sup>  
H : 14 CM - 5 IN<sup>1/2</sup>

161015  
**SALADIER**  
DEEP BOWL, MEDIUM  
ENSALADERA  
25 CM - 9 IN<sup>13/16</sup>  
CONTENANCE : 150 CL  
CAPACITY : 50 OZ<sup>3/4</sup>  
H : 11,5 CM - 4 IN<sup>1/4</sup>

161014  
**SALADIER/BOL**  
DEEP BOWL, INDIVIDUAL  
BOL  
16,5 CM - 6 IN<sup>1/2</sup>  
CONTENANCE : 50 CL  
CAPACITY : 16 OZ<sup>15/16</sup>  
H : 9 CM - 3 IN<sup>15/16</sup>



161013  
**SALADIER/BOL**  
DEEP BOWL, CUP  
BOL  
9 CM - 3 IN<sup>9/16</sup>  
CONTENANCE : 20 CL  
CAPACITY : 6 OZ<sup>1/4</sup>  
H : 7 CM - 2 IN<sup>9/16</sup>



161020  
**COQUETIER**  
EGG CUP, PLATE  
HUEVERA  
15 CM - 5 IN<sup>7/8</sup>

161037  
**RAVIER**  
SHALLOW RAMEKIN, COUPE  
BOL  
10 CM - 3 IN<sup>15/16</sup>  
H : 4 CM - 1 IN<sup>3/8</sup>



198017  
**POT À SAUCE/GARNITURE**  
RAMEKIN, LARGE  
POT  
48 CL - 16 OZ<sup>1/4</sup>  
Ø 10,5 CM - 4 IN<sup>1/8</sup>  
H : 8 CM - 2 IN<sup>11/16</sup>



198016  
**POT À SAUCE/GARNITURE**  
RAMEKIN, SUGAR BOWL  
POT  
20 CL - 6 OZ<sup>3/4</sup>  
Ø 8 CM - 3 IN<sup>1/8</sup>  
H : 7 CM - 2 IN<sup>8/16</sup>



196561  
**POT À SAUCE/GARNITURE**  
RAMEKIN, SMALL  
POT  
7,5 CL - 2 OZ<sup>9/16</sup>  
Ø 5,5 CM - 2 IN<sup>3/16</sup>  
H : 6,5 CM - 2 IN<sup>9/16</sup>



214688  
**SOUCOUBE UNIVERSELLE**  
UNIVERSAL SAUCER CUP  
PLATO UNIVERSAL  
13 CM - 5 IN<sup>1/8</sup>



161036  
**SUPPORT PLATEAU**  
TRAY STAND, 3 PLACES  
FUENTE CON 3 ESPACIOS  
30,5 X 10 CM - 12 IN X 3 IN<sup>15/16</sup>



207766  
**TASSE À ESPRESSO**  
ESPRESSO CUP  
ESPRESSO DE TAZA  
6 CL - 2 OZ

161025  
**SOUCOUBE À CAFÉ/ESPRESSO**  
DEMITASSE/ESPRESSO SAUCER  
ESPRESSO DE PLATO  
15 CM - 5 IN<sup>7/8</sup>



208948  
**TASSE À CAFÉ**  
DEMITASSE CUP  
TAZA DE CAFÉ  
11 CL - 3 OZ<sup>3/4</sup>



207767  
**TASSE À THÉ/LUNGO**  
COFFEE/TEA CUP  
LUNGO DE TAZA  
20 CL - 6 OZ<sup>3/4</sup>

161028  
**SOUCOUBE À THÉ/LUNGO**  
COFFEE/TEA SAUCER  
LUNGO DE PLATO  
18 CM - 7 IN<sup>1/16</sup>



207768  
**TASSE À DÉJEUNER**  
BREAKFAST CUP  
TAZA DESAYUNO  
48 CL - 16 OZ<sup>1/4</sup>

161034  
**SOUCOUBE À DÉJEUNER**  
BREAKFAST SAUCER  
PLATO DESAYUNO  
21 CM - 8 IN<sup>1/4</sup>



207765  
**MUG**  
MUG, LARGE  
MUG  
50 CL - 16 OZ<sup>15/16</sup>

209189  
**MUG**  
MUG  
MUG  
30 CL - 10 OZ<sup>1/8</sup>

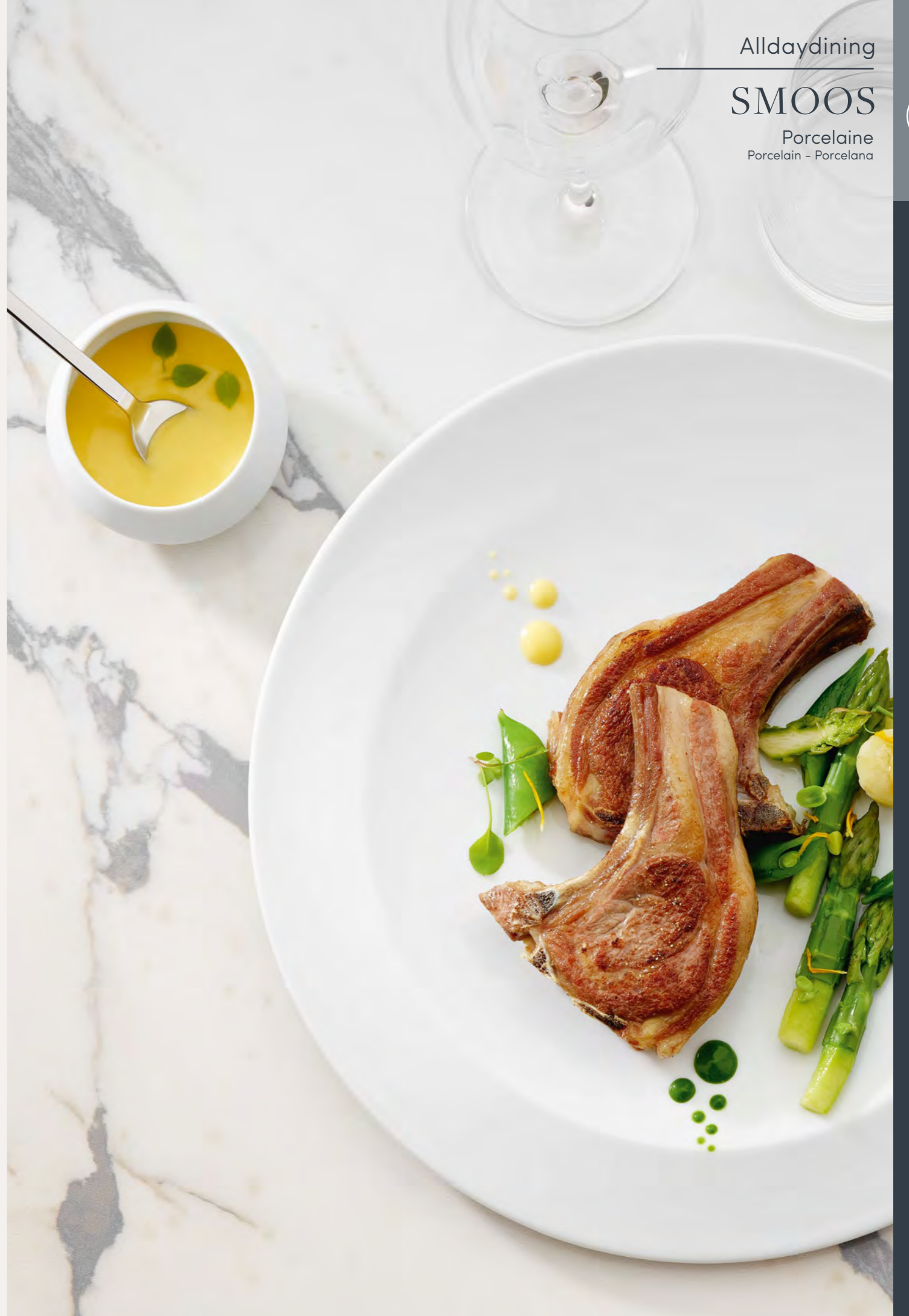

**BLANC ROND - ROUND WHITE - BLANCO REDONDO**



- 207120 **ASSIETTE DE PRÉSENTATION**  
PRESENTATION COUPE PLATE  
PLATO PRESENTACIÓN  
32 CM - 12 IN<sup>5/8</sup>
- 207112 **ASSIETTE PLATE**  
DINNER COUPE PLATE  
PLATO REDONDO  
29 CM - 11 IN<sup>7/16</sup>
- 207113 **ASSIETTE PLATE**  
DINNER COUPE PLATE  
PLATO REDONDO  
26 CM - 10 IN<sup>1/4</sup>
- \*239142 **NEW ASSIETTE PLATE**  
DINNER COUPE PLATE  
PLATO REDONDO  
24 CM - 9 IN<sup>7/16</sup>
- 207111 **ASSIETTE DESSERT**  
DESSERT/SALAD/  
APP.COUPE PLATE  
PLATO REDONDO  
20 CM - 7 IN<sup>7/8</sup>
- 207119 **ASSIETTE À PAIN**  
BREAD & BUTTER  
COUPE PLATE  
PLATO DE PAN  
15 CM - 5 IN<sup>7/8</sup>
- 188537 **BOL À SOUPE**  
MED BOWL, SOUP  
BOL HONDO  
13 CM - 5 IN<sup>1/8</sup>  
H : 6 CM - 2 IN<sup>3/8</sup>
- 207114 **ASSIETTE CREUSE/  
CALOTTE**  
ROUND SHALLOW BOWL  
PLATO HONDO  
20 CM - 7 IN<sup>7/8</sup>



- 142722 **BOL**  
DEEP BOWL, LARGE  
BOL HONDO  
28 CM - 11 IN  
CONTENANCE : 2,5 L  
CAPACITY : 84 OZ<sup>3/16</sup>  
H : 12 CM - 4 IN<sup>3/4</sup>
- 136529 **BOL**  
DEEP BOWL, MEDIUM  
BOL HONDO  
24 CM - 9 IN<sup>7/16</sup>  
CONTENANCE : 2 L  
CAPACITY : 67 OZ<sup>5/16</sup>  
H : 11 CM - 4 IN<sup>1/4</sup>
- 136511 **BOL**  
DEEP BOWL, MEDIUM  
BOL HONDO  
20 CM - 7 IN<sup>7/8</sup>  
CONTENANCE : 1,30 L  
CAPACITY : 43 OZ<sup>5/16</sup>  
H : 9,5 CM - 3 IN<sup>3/4</sup>
- 136528 **BOL**  
DEEP BOWL, INDIVIDUAL  
BOL HONDO  
16 CM - 6 IN<sup>5/16</sup>  
CONTENANCE : 67 CL  
CAPACITY : 22 OZ<sup>5/16</sup>  
H : 7,5 CM - 2 IN<sup>5/16</sup>
- 154245 **BOL**  
DEEP BOWL, SOUP  
BOL HONDO  
14 CM - 5 IN<sup>1/2</sup>  
CONTENANCE : 55 CL  
CAPACITY : 18 OZ<sup>5/16</sup>  
H : 8 CM - 2 IN<sup>1/16</sup>
- 136510 **BOL**  
DEEP BOWL, RICE  
BOL HONDO  
12 CM - 4 IN<sup>3/4</sup>  
CONTENANCE : 27 CL  
CAPACITY : 9 OZ<sup>7/16</sup>  
H : 5,5 CM - 2 IN<sup>3/16</sup>
- 136509 **BOL**  
DEEP BOWL, RAMEKIN  
BOL HONDO  
8 CM - 3 IN<sup>1/8</sup>  
CONTENANCE : 8 CL  
CAPACITY : 3 OZ<sup>1/16</sup>  
H : 4,5 CM - 1 IN<sup>3/4</sup>



- 136535 **COUPE**  
PASTA/SALAD/SEAFOOD  
BOWL, FOOTED  
BOL  
24 CM - 9 IN<sup>7/16</sup>  
H : 11 CM - 4 IN<sup>1/4</sup>
- 136532 **COUPE**  
SHALLOW BOWL,  
FOOTED  
BOL  
16 CM - 6 IN<sup>5/16</sup>  
H : 7,5 CM - 2 IN<sup>15/16</sup>
- 136530 **COUPE**  
SHALLOW BOWL,  
FOOTED  
BOL  
8 CM - 3 IN<sup>1/8</sup>  
H : 2,5 CM - 1 IN
- 233841 **BOL CONIQUE**  
CONIC BOWL  
BOL CÓNICO  
30 CL - 10 OZ<sup>1/8</sup>
- 233842 **BOL CONIQUE**  
CONIC BOWL  
BOL CÓNICO  
1,15 L - 38 OZ<sup>7/8</sup>

**GRIS PERLE - LIGHT GREY - GRIS PERLA**



- 230142 **BOL**  
DEEP BOWL, MEDIUM  
BOL HONDO  
24 CM - 9 IN<sup>7/16</sup>  
CONTENANCE : 2 L  
CAPACITY : 67 OZ<sup>5/16</sup>  
H : 11 CM - 4 IN<sup>1/4</sup>
- 230141 **BOL**  
DEEP BOWL, MEDIUM  
BOL HONDO  
20 CM - 7 IN<sup>7/8</sup>  
CONTENANCE : 1,30 L  
CAPACITY : 43 OZ<sup>5/16</sup>  
H : 9,5 CM - 3 IN<sup>3/4</sup>
- 230140 **BOL**  
DEEP BOWL, INDIVIDUAL  
BOL HONDO  
16 CM - 6 IN<sup>5/16</sup>  
CONTENANCE : 67 CL  
CAPACITY : 22 OZ<sup>5/16</sup>  
H : 7,5 CM - 2 IN<sup>5/16</sup>
- 230139 **BOL À DÉJEUNER**  
SOUP/BREAKFAST BOWL  
BOL DESAYUNO  
14 CM - 5 IN<sup>1/2</sup>  
CONTENANCE : 55 CL  
CAPACITY : 18 OZ<sup>5/16</sup>  
H : 8 CM - 2 IN<sup>1/16</sup>
- 230138 **BOL À THÉ**  
TEA BOWL, RAMEKIN  
BOL HONDO  
9 CM - 3 IN<sup>3/8</sup>  
CONTENANCE : 20 CL  
CAPACITY : 6 OZ<sup>3/4</sup>  
H : 4,5 CM - 1 IN<sup>3/4</sup>

\*Disponible à partir de mai 2020  
Available in May 2020  
Disponibile en mayo 2020



©Julie ANSIAU



CARRÉE - SQUARE PLATE - PLATO CUADRADO



207118  
**ASSIETTE DE PRÉSENTATION**  
PRESENTATION COUPE PLATE  
PLATO PRESENTACIÓN  
28 CM - 11 IN



207115  
**ASSIETTE PLATE**  
DINNER COUPE PLATE  
PLATO  
24 CM - 9 IN<sup>7/8</sup>



207117  
**ASSIETTE DESSERT**  
DESSERT/SALAD/APP.COUPE PLATE  
PLATO  
20 CM - 7 IN<sup>7/8</sup>



207123  
**ASSIETTE À PAIN**  
BREAD & BUTTER COUPE PLATE  
PLATO DE PAN  
14 CM - 5 IN<sup>7/2</sup>

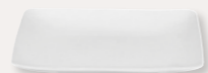

207116  
**ASSIETTE CREUSE**  
SOUP/SALAD, COUPE PLATE  
PLATO HONDO CUADRADO  
20 CM - 7 IN<sup>7/8</sup>



149831  
**PLAT CREUX**  
SQUARE DEEP DISH, COUPE  
PLATO HONDO  
28 CM - 11 IN  
H : 5,5 CM - 2 IN<sup>3/16</sup>



154244  
**PLAT CREUX**  
SQUARE DEEP DISH, COUPE  
PLATO HONDO  
16 CM - 6 IN<sup>5/16</sup>  
H : 6 CM - 2 IN<sup>3/8</sup>



136502  
**COUPE**  
SQUARE BOWL, FOOTED COUPE  
BOL  
12 CM - 4 IN<sup>3/4</sup>  
H : 3,5 CM - 1 IN<sup>3/8</sup>



136503  
**COUPE**  
SQUARE BOWL, FOOTED COUPE  
BOL  
8 CM - 3 IN<sup>1/8</sup>  
H : 2,5 CM - 1 IN



181483  
**BOL CARRÉ**  
SQUARE BOWL, DEEP  
BOL HONDO  
12 CM - 4 IN<sup>3/4</sup>  
H : 3,5 CM - 1 IN<sup>3/8</sup>

RECTANGULAIRE - RECTANGULAR PLATE - PLATO RECTANGULAR



181485  
**ASSIETTE PLATE**  
PRESENTATION COUPE PLATE  
PLATO RECTANGULAR  
34 X 26 CM  
13 IN<sup>3/8</sup> X 10 IN<sup>1/4</sup>



207122  
**ASSIETTE PLATE**  
DINNER COUPE PLATE  
PLATO RECTANGULAR  
30 X 22 CM  
11 IN<sup>13/16</sup> X 8 IN<sup>10/16</sup>



207110  
**ASSIETTE DESSERT**  
DESSERT/SALAD/APP COUPE PLATE  
PLATO RECTANGULAR  
26 X 18 CM  
10 IN<sup>1/4</sup> X 7 IN<sup>10/16</sup>

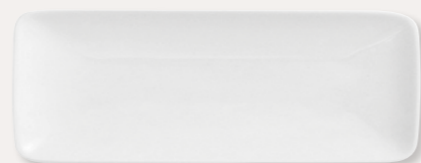

207754  
**PLAT RECTANGULAIRE**  
RECTANGULAR DISH, COUPE LARGE  
PLATO RECTANGULAR  
40 X 16 CM  
15 IN<sup>3/4</sup> X 6 IN<sup>5/16</sup>

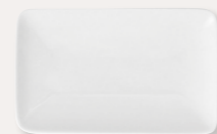

207753  
**PLAT RECTANGULAIRE**  
RECTANGULAR DISH, COUPE LARGE  
PLATO RECTANGULAR  
20 X 12 CM  
7 IN<sup>7/8</sup> X 4 IN<sup>3/4</sup>

ACCESSOIRES - ACCESSORIES - ACCESORIOS



209382  
**PRÉSENTOIR À GÂTEAUX**  
ROUND APP/PIZZA/PRESENTATION STAND  
EXPOSITOR DE TARTAS  
32 CM - 12 IN<sup>5/8</sup>  
H : 10,5 CM - 4 IN<sup>1/4</sup>



209381  
**PRÉSENTOIR À GÂTEAUX**  
ROUND APP/PIZZA/PRESENTATION STAND  
EXPOSITOR DE TARTAS  
25 CM - 9 IN<sup>13/16</sup>  
H : 8,5 CM - 2 IN<sup>3/16</sup>



136524  
**PLAT À TARTE**  
PIE/PIZZA PLATE, FLAT  
FUENTE PARA PASTEL  
32 CM - 12 IN<sup>5/8</sup>



181490  
**VERRINE PORCELAINE**  
RAMEKIN  
VASITO PORCELANA  
8 CL - 2 OZ<sup>1/16</sup>



182915  
**COFFRET SALIÈRE/POIVRIÈRE**  
SALT & PEPPER CRUET  
SALERO Y PIMENTERO

NEWCOOK MODULO



162015  
**RAMEQUIN**  
RAMEKIN  
RAMEKIN  
9,5 CM - 3 IN<sup>3/4</sup>



162013  
**BOL À CONSOMÉ**  
SOUP BOWL  
BOL CONSOMÉ  
10,5 CM - 4 IN<sup>9/8</sup>  
50 CL - 16 OZ<sup>15/16</sup>



162011  
**ASSIETTE À CRÈME BRÛLÉE**  
«CRÈME BRÛLÉE» DISH  
PLATO PARA GRATINAR  
14 CM - 5 IN<sup>1/2</sup>

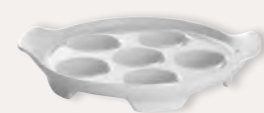

164138  
**PLAT À ESCARGOTS 6 PLACES**  
SNAIL TRAY 6 SPACES  
BANDEJA CARACOLAS 6 COMPARTIMENTOS  
16,6 X 11,2 CM - 6 IN<sup>3/16</sup> X 4 IN<sup>7/16</sup>



©Julie ANSIAU







207131  
**ASSIETTE PLATE RECTANGLE  
6 COMPARTIMENTS**  
RECTANGULAR DINNER PLATE  
6 COMPARTIMENTS  
PLATO RECTANGULAR/6 COMPARTIMENTOS  
27X18 CM - 10 IN<sup>5/8</sup> X 7 IN<sup>11/16</sup>

207133  
**SOUCOUPE RECTANGULAIRE**  
RECTANGULAR PLATE/ SAUCER  
PLATO RECTANGULAR  
27X9 CM - 10 IN<sup>5/8</sup> X 3 IN<sup>9/16</sup>





234605  
**ASSIETTE DE PRÉSENTATION**  
PRESENTATION PLATE  
PLATO PRESENTACIÓN  
EXT : 32 CM - 12 IN<sup>5/8</sup>  
INT : 19 CM - 7 IN<sup>3/4</sup>



234612  
**ASSIETTE DE PRÉSENTATION**  
PRESENTATION PLATE  
PLATO PRESENTACIÓN  
EXT : 30 CM - 11 IN<sup>3/16</sup>  
INT : 18 CM - 7 IN<sup>1/16</sup>

234607  
**ASSIETTE PLATE**  
DINNER PLATE  
PLATO REDONDO  
EXT : 26,5 CM - 10 IN<sup>7/16</sup>  
INT : 17 CM - 6 IN<sup>10/16</sup>

234608  
**ASSIETTE DESSERT**  
DESSERT PLATE  
PLATO REDONDO  
EXT : 21,5 CM - 8 IN<sup>7/16</sup>  
INT : 13 CM - 5 IN<sup>1/8</sup>

234611  
**ASSIETTE DESSERT**  
DESSERT PLATE  
PLATO REDONDO  
EXT : 18,5 CM - 7 IN<sup>5/16</sup>  
INT : 11 CM - 4 IN<sup>5/16</sup>



234609  
**ASSIETTE CREUSE CALOTTE**  
CEREAL PLATE  
PLATO HONDO  
EXT : 19 CM - 7 IN<sup>1/2</sup>  
INT : 12 CM - 4 IN<sup>3/4</sup>



234610  
**ASSIETTE CREUSE BORD À AILE**  
ROUND DEEP PLATE  
PLATO HONDO  
EXT : 22,5 CM - 8 IN<sup>7/8</sup>  
INT : 13 CM - 5 IN<sup>1/8</sup>



234603  
**ASSIETTE À PAIN**  
BREAD PLATE  
PLATO DE PAN  
EXT : 16 CM - 6 IN<sup>5/16</sup>  
INT : 10 CM - 3 IN<sup>15/16</sup>



234604  
**BOL À SALADE AVEC AILE**  
SALAD BOWL WITH RIM  
BOL DE ENSALADA CON ALETA  
17,5 CM - 6 IN<sup>7/8</sup>



234606  
**PLAT OVALE**  
OVAL DISH  
FUENTE OVALADO  
36,5 X 26,5 CM - 14 IN<sup>3/8</sup> X 10 IN<sup>7/16</sup>



**PORCELAINE BLANCHE - WHITE PORCELAIN - PORCELANA BLANCO**



216529  
**ASSIETTE ULTRA PLATE RONDE**  
ROUND ULTRA PLATE  
PLATO SÚPER PLANO  
25 CM - 9 IN<sup>5/16</sup>



216531  
**ASSIETTE ULTRA PLATE RONDE**  
ROUND ULTRA PLATE  
PLATO SÚPER PLANO  
12 CM - 4 IN<sup>1/4</sup>



216536  
**ASSIETTE À CRÈME BRÛLÉE**  
«CRÈME BRÛLÉE» ROUND PLATE  
PLATO PARA GRATINAR  
13,5 CM - 5 IN<sup>5/16</sup>

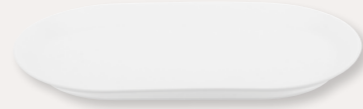

216532  
**ASSIETTE OBLONGUE**  
OBLONG PLATE  
PLATO OBLANGA  
32 X 19 CM - 12 IN<sup>7/8</sup> X 7 IN<sup>1/2</sup>



216530  
**ASSIETTE À SALADE RONDE AVEC PIED**  
FOOTED ROUND DEEP PLATE  
PLATO DE ENSALADA CON PIE  
20 CM - 7 IN<sup>7/8</sup>



216535  
**COUPELLE RONDE AVEC PIED**  
FOOTED ROUND DEEP PLATE  
BOL PEQUEÑO CON PIE  
14 CM - 5 IN<sup>1/2</sup>



216534  
**COUPELLE RONDE AVEC PIED**  
FOOTED ROUND DEEP PLATE  
BOL PEQUEÑO CON PIE  
12 CM - 4 IN<sup>3/4</sup>

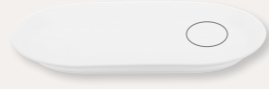

216533  
**ASSIETTE OBLONGUE**  
OBLONG PLATE  
PLATO OBLANGA  
20 X 12 CM - 7 IN<sup>7/8</sup> X 4 IN<sup>3/4</sup>

**GRÈS GRIS - GRES STONEWARE - ARENISCA**



198935  
**PLAT À GRATIN ROND**  
ROUND CASSEROLE PLATE  
PLATO PARA GRATINAR  
14 CM - 5 IN<sup>1/2</sup>



198939  
**BOL À CONSOMÉ**  
SOUP BOWL  
BOL CONSOMÉ  
13 CM - 5 IN<sup>5/8</sup>



198936  
**GOBELET ROND**  
ROUND TUMBLER  
VASO REDONDO  
9 CM - 3 IN<sup>9/16</sup>

**EMPILABLE**  
STACKABLE  
APILABLE



©Patrick ROUGEREAU

Alldaydining

**ESSENTIELLE**

Porcelaine - Grès  
Porcelain/Stoneware - Porcelana/Arenisca

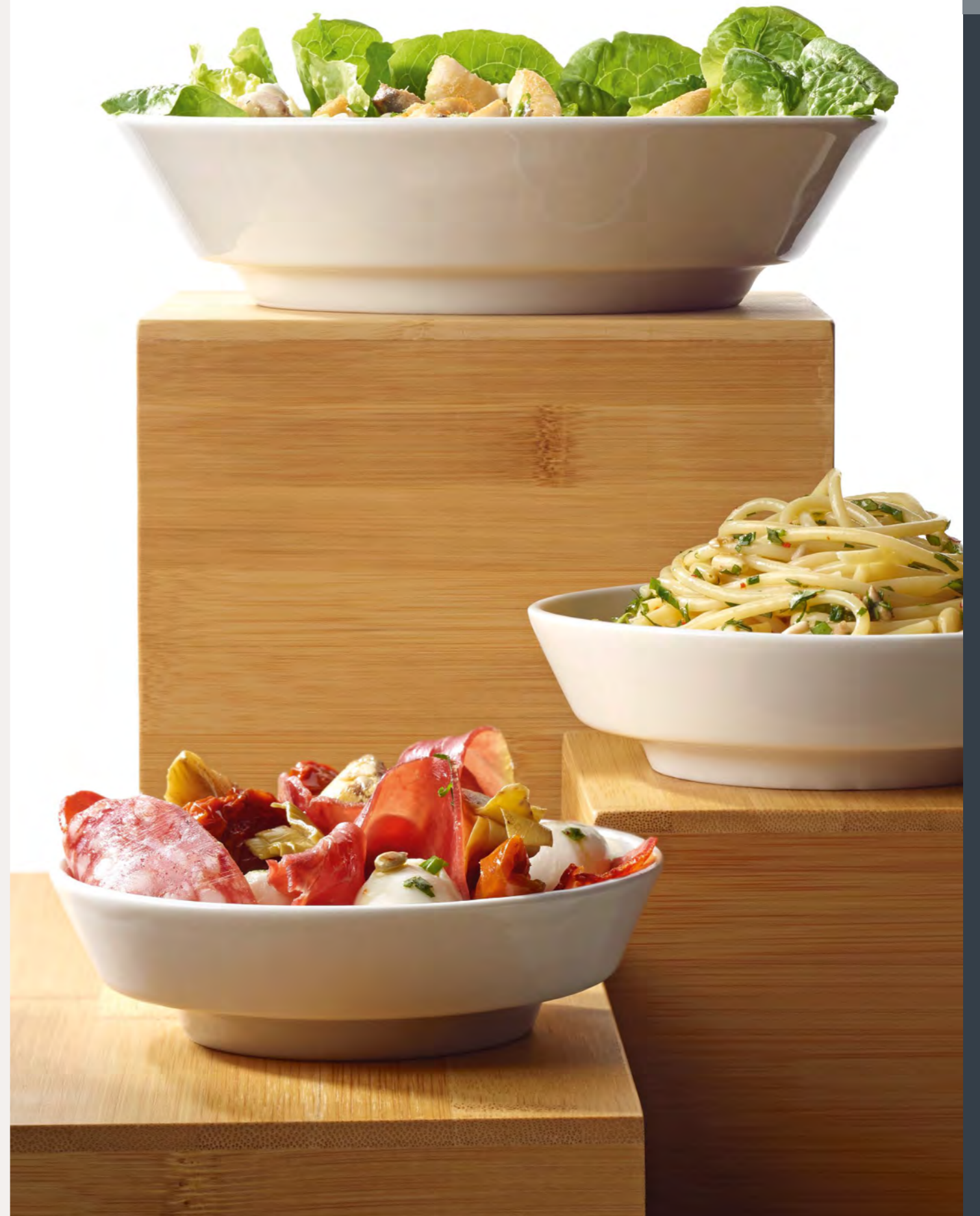

# COCOTTES

Porcelaine - Grès  
Porcelain/Stoneware - Porcelana/Arenisca



# COCOTTES

Porcelaine - Grès  
Porcelain/Stoneware - Porcelana/Arenisca

EMPILABLE - STACKABLE - APILABLE

**BLANC**  
WHITE  
BLANCO



234342



235064



234341



209383



209384



234340



186849



211891

**BLANC SABLÉ**  
SANDY WHITE  
ACABADO COLOR ARENA



234345



235065



234344



209720



209384



234343



211893



211892

**CARBONE**  
CARBONE/BLACK  
NEGRO



234336



235066



234335



204041

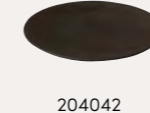

204042



234334



234209

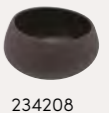

234208

**BLEU**  
BLUE  
AZUL



234339



235063



234338



230821



230820



234337



230822



230823

**ONYX** NEW  
ONYX  
ONYX



236555



236556



236554



236553

**DUNE**  
BEIGE DUNE  
BEIS DUNA



230927



230928



230926

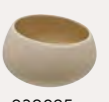

230925

**BASALTE**  
BROWN BASALT  
BASALTO



230944



230945



230943



230942

**ARGILE VERTE**  
GREEN CLAY  
ARCILLA VERDE



230958



230959



230957



230956

**BLEU DE ROCHE**  
BLUE STONE  
AZUL DE ROCA



230972



230973



230971

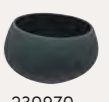

230970

**ROSE SABLE**  
PINK SAND  
ROSA ARENA



230910



230911



230909



230908

(1)ASSIETTE COCOTTE  
CASSEROLE PLATE  
PLATO COCOTTE  
22 CM - 8 IN<sup>7/16</sup>  
100 CL - 33 OZ<sup>3/16</sup>

(2)ASSIETTE COCOTTE  
CASSEROLE PLATE  
PLATO COCOTTE  
18 CM - 7 IN<sup>7/16</sup>  
70 CL - 23 OZ<sup>1/16</sup>

BOL COCOTTE  
ROUND CASSEPOLE  
BOL COCOTTE  
17,5 CM - 6 IN<sup>7/16</sup>  
140 CL - 47 OZ<sup>5/16</sup>

(3)BOL COCOTTE  
ROUND CASSEPOLE  
BOL COCOTTE  
14 CM - 5 IN<sup>1/2</sup>  
50 CL - 16 OZ<sup>5/16</sup>

ASSIETTE/COUVERCLE  
ROUND PLATE/CASSEPOLE LID  
BOL /PLATO PAN RONDO  
12,5 CM - 4 IN<sup>5/16</sup>

BOL BISEAUTÉ COCOTTE  
SLANTED RIM BOWL  
BOL BISEADO COCOTTE  
16 CM - 6 IN<sup>5/16</sup>  
100 CL - 33 OZ<sup>5/16</sup>

(4)BOL BISEAUTÉ COCOTTE  
SLANTED RIM BOWL  
BOL BISEADO COCOTTE  
12 CM - 4 IN<sup>3/4</sup>  
30 CL - 10 OZ<sup>7/8</sup>

BOL BISEAUTÉ COCOTTE  
SLANTED RIM BOWL  
BOL BISEADO COCOTTE  
7,3 CM - 2 IN<sup>7/8</sup>  
7 CL - 2 OZ<sup>7/8</sup>





- 236549 **ASSIETTE PLATE**  
ROUND DINNER PLATE  
PLATO REDONDO  
EXT : 29 CM - 11 IN<sup>7/16</sup>  
INT : 25,5 CM - 10 IN<sup>1/16</sup>
- 236548 **ASSIETTE PLATE**  
ROUND DINNER PLATE  
PLATO REDONDO  
EXT : 26 CM - 10 IN<sup>1/4</sup>  
INT : 22 CM - 8 IN<sup>1/16</sup>
- 236547 **ASSIETTE PLATE**  
ROUND DINNER PLATE  
PLATO REDONDO  
EXT : 23 CM - 9 IN<sup>1/16</sup>  
INT : 19,5 CM - 7 IN<sup>1/16</sup>
- 236546 **ASSIETTE À PAIN**  
ROUND BREAD & BUTTER PLATE  
PLATO DE PAN  
EXT : 14 CM - 5 IN<sup>1/2</sup>  
INT : 10 CM - 3 IN<sup>5/16</sup>
- 236550 **ASSIETTE CREUSE**  
ROUND DEEP PLATE  
PLATO HONDO  
EXT : 20 CM - 7 IN<sup>7/8</sup>  
INT : 16,5 CM - 6 IN<sup>1/2</sup>
- 236556 **ASSIETTE /COUVERCLE**  
ROUND PLATE/CASSEROLE LID  
BOL/PLATO RONDO PAN  
12,5 CM - 4 IN<sup>5/16</sup>
- 236555 **BOL COCOTTE**  
ROUND CASSEROLE  
BOL COCOTTE  
14 CM - 5 IN<sup>1/2</sup> - 50 CL - 16 OZ<sup>5/16</sup>
- 236552 **ASSIETTE GOURMET GRAND BASSIN**  
SHALLOW BOWL W/WIDE ROUND RIM  
PLATO GOURMET HONDO FONDO GRANDE  
EXT : 26 CM - 10 IN<sup>1/4</sup>  
INT : 14 CM - 5 IN<sup>1/2</sup>
- 236554 **BOL BISEAUTÉ COCOTTE**  
SLANTED RIM BOWL  
BOL BISEADO COCOTTE  
12 CM - 4 IN<sup>3/4</sup> - 30 CL - 10 OZ<sup>1/8</sup>
- 236551 **ASSIETTE GOURMET PETIT BASSIN**  
SHALLOW BOWL W/WIDE ROUND RIM  
PLATO GOURMET REDONDO FONDO PEQUEÑO  
EXT : 23 CM - 9 IN<sup>1/16</sup>  
INT : 11,5 CM - 4 IN<sup>1/2</sup>

**ROSE SABLE - PINK SAND - ROSA ARENA**



- 230904 **ASSIETTE PLATE**  
ROUND DINNER PLATE  
PLATO REDONDO  
EXT : 29 CM - 11 IN<sup>7/16</sup>  
INT : 25,5 CM - 10 IN<sup>1/16</sup>
- 230903 **ASSIETTE PLATE**  
ROUND DINNER PLATE  
PLATO REDONDO  
EXT : 26 CM - 10 IN<sup>1/4</sup>  
INT : 22 CM - 8 IN<sup>1/16</sup>
- 230902 **ASSIETTE PLATE**  
ROUND DINNER PLATE  
PLATO REDONDO  
EXT : 23 CM - 9 IN<sup>1/16</sup>  
INT : 19,5 CM - 7 IN<sup>1/16</sup>
- 230901 **ASSIETTE À PAIN**  
ROUND BREAD & BUTTER PLATE  
PLATO DE PAN  
EXT : 14 CM - 5 IN<sup>1/2</sup>  
INT : 10 CM - 3 IN<sup>5/16</sup>
- 230905 **ASSIETTE CREUSE**  
ROUND DEEP PLATE  
PLATO HONDO  
EXT : 20 CM - 7 IN<sup>7/8</sup>  
INT : 16,5 CM - 6 IN<sup>1/2</sup>
- 230911 **ASSIETTE/COUVERCLE**  
ROUND PLATE/CASSEROLE LID  
BOL/PLATO RONDO PAN  
12,5 CM - 4 IN<sup>5/16</sup>
- 230910 **BOL COCOTTE**  
ROUND CASSEROLE  
BOL COCOTTE  
14 CM - 5 IN<sup>1/2</sup> - 50 CL - 16 OZ<sup>5/16</sup>
- 230907 **ASSIETTE GOURMET GRAND BASSIN**  
SHALLOW BOWL W/WIDE ROUND RIM  
PLATO GOURMET HONDO FONDO GRANDE  
EXT : 26 CM - 10 IN<sup>1/4</sup>  
INT : 14 CM - 5 IN<sup>1/2</sup>
- 230909 **BOL BISEAUTÉ COCOTTE**  
SLANTED RIM BOWL  
BOL BISEADO COCOTTE  
12 CM - 4 IN<sup>3/4</sup> - 30 CL - 10 OZ<sup>1/8</sup>
- 230906 **ASSIETTE GOURMET PETIT BASSIN**  
SHALLOW BOWL W/WIDE ROUND RIM  
PLATO GOURMET REDONDO FONDO PEQUEÑO  
EXT : 23 CM - 9 IN<sup>1/16</sup>  
INT : 11,5 CM - 4 IN<sup>1/2</sup>

**ARGILE VERTE - GREEN CLAY - ARCILLA VERDE**



- 230952 **ASSIETTE PLATE**  
ROUND DINNER PLATE  
PLATO REDONDO  
EXT : 29 CM - 11 IN<sup>7/16</sup>  
INT : 25,5 CM - 10 IN<sup>1/16</sup>
- 230951 **ASSIETTE PLATE**  
ROUND DINNER PLATE  
PLATO REDONDO  
EXT : 26 CM - 10 IN<sup>1/4</sup>  
INT : 22 CM - 8 IN<sup>1/16</sup>
- 230950 **ASSIETTE PLATE**  
ROUND DINNER PLATE  
PLATO REDONDO  
EXT : 23 CM - 9 IN<sup>1/16</sup>  
INT : 19,5 CM - 7 IN<sup>1/16</sup>
- 230949 **ASSIETTE À PAIN**  
ROUND BREAD & BUTTER PLATE  
PLATO DE PAN  
EXT : 14 CM - 5 IN<sup>1/2</sup>  
INT : 10 CM - 3 IN<sup>5/16</sup>
- 230953 **ASSIETTE CREUSE**  
ROUND DEEP PLATE  
PLATO HONDO  
EXT : 20 CM - 7 IN<sup>7/8</sup>  
INT : 16,5 CM - 6 IN<sup>1/2</sup>
- 230959 **ASSIETTE /COUVERCLE**  
ROUND PLATE/CASSEROLE LID  
BOL/PLATO RONDO PAN  
12,5 CM - 4 IN<sup>5/16</sup>
- 230958 **BOL COCOTTE**  
ROUND CASSEROLE  
BOL COCOTTE  
14 CM - 5 IN<sup>1/2</sup> - 50 CL - 16 OZ<sup>5/16</sup>
- 230955 **ASSIETTE GOURMET GRAND BASSIN**  
SHALLOW BOWL W/WIDE ROUND RIM  
PLATO GOURMET HONDO FONDO GRANDE  
EXT : 26 CM - 10 IN<sup>1/4</sup>  
INT : 14 CM - 5 IN<sup>1/2</sup>
- 230957 **BOL BISEAUTÉ COCOTTE**  
SLANTED RIM BOWL  
BOL BISEADO COCOTTE  
12 CM - 4 IN<sup>3/4</sup> - 30 CL - 10 OZ<sup>1/8</sup>
- 230954 **ASSIETTE GOURMET PETIT BASSIN**  
SHALLOW BOWL W/WIDE ROUND RIM  
PLATO GOURMET REDONDO FONDO PEQUEÑO  
EXT : 23 CM - 9 IN<sup>1/16</sup>  
INT : 11,5 CM - 4 IN<sup>1/2</sup>



©Patrick ROUGEREAU



**BASALTE - BROWN BASALT - BASALTO**

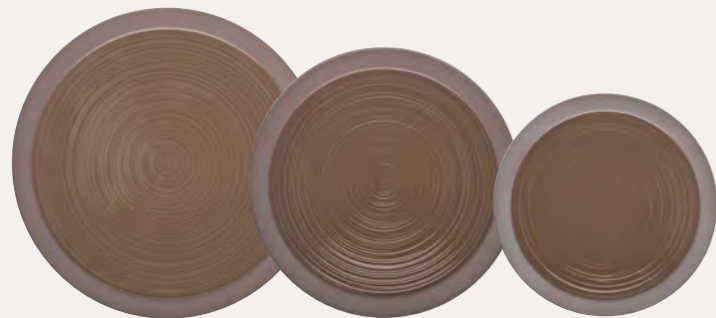

230938  
**ASSIETTE PLATE**  
ROUND DINNER PLATE  
PLATO REDONDO  
EXT : 29 CM - 11 IN<sup>7/16</sup>  
INT : 25,5 CM - 10 IN<sup>1/16</sup>

230937  
**ASSIETTE PLATE**  
ROUND DINNER PLATE  
PLATO REDONDO  
EXT : 26 CM - 10 IN<sup>1/4</sup>  
INT : 22 CM - 8 IN<sup>15/16</sup>

230936  
**ASSIETTE PLATE**  
ROUND DINNER PLATE  
PLATO REDONDO  
EXT : 23 CM - 9 IN<sup>1/16</sup>  
INT : 19,5 CM - 7 IN<sup>1/16</sup>



230935  
**ASSIETTE À PAIN**  
ROUND BREAD & BUTTER PLATE  
PLATO DE PAN  
EXT : 14 CM - 5 IN<sup>1/2</sup>  
INT : 10 CM - 3 IN<sup>5/16</sup>



230939  
**ASSIETTE CREUSE**  
ROUND DEEP PLATE  
PLATO HONDO  
EXT : 20 CM - 7 IN<sup>7/8</sup>  
INT : 16,5 CM - 6 IN<sup>1/2</sup>



230945  
**ASSIETTE /COUVERCLE**  
ROUND PLATE/CASSEROLE LID  
BOL/PLATO RONDO PAN  
12,5 CM - 4 IN<sup>15/16</sup>

230944  
**BOL COCOTTE**  
ROUND CASSEROLE  
BOL COCOTTE  
14 CM - 5 IN<sup>1/2</sup> - 50 CL - 16 OZ<sup>15/16</sup>



230941  
**ASSIETTE GOURMET GRAND BASSIN**  
SHALLOW BOWL W/WIDE ROUND RIM  
PLATO GOURMET HONDO FONDO GRANDE  
EXT : 26 CM - 10 IN<sup>1/4</sup>  
INT : 14 CM - 5 IN<sup>1/2</sup>

230940  
**ASSIETTE GOURMET PETIT BASSIN**  
SHALLOW BOWL W/WIDE ROUND RIM  
PLATO GOURMET REDONDO FONDO PEQUEÑO  
EXT : 23 CM - 9 IN<sup>1/16</sup>  
INT : 11,5 CM - 4 IN<sup>1/2</sup>

**BLEU DE ROCHE - BLUE STONE - AZUL DE ROCA**

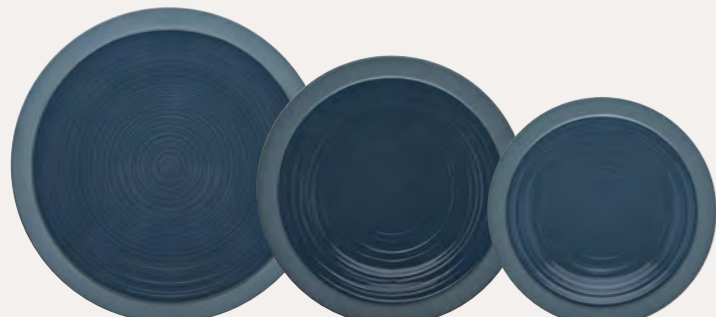

230966  
**ASSIETTE PLATE**  
ROUND DINNER PLATE  
PLATO REDONDO  
EXT : 29 CM - 11 IN<sup>7/16</sup>  
INT : 25,5 CM - 10 IN<sup>1/16</sup>

230965  
**ASSIETTE PLATE**  
ROUND DINNER PLATE  
PLATO REDONDO  
EXT : 26 CM - 10 IN<sup>1/4</sup>  
INT : 22 CM - 8 IN<sup>15/16</sup>

230964  
**ASSIETTE PLATE**  
ROUND DINNER PLATE  
PLATO REDONDO  
EXT : 23 CM - 9 IN<sup>1/16</sup>  
INT : 19,5 CM - 7 IN<sup>1/16</sup>



230963  
**ASSIETTE À PAIN**  
ROUND BREAD & BUTTER PLATE  
PLATO DE PAN  
EXT : 14 CM - 5 IN<sup>1/2</sup>  
INT : 10 CM - 3 IN<sup>5/16</sup>



230967  
**ASSIETTE CREUSE**  
ROUND DEEP PLATE  
PLATO HONDO  
EXT : 20 CM - 7 IN<sup>7/8</sup>  
INT : 16,5 CM - 6 IN<sup>1/2</sup>



230973  
**ASSIETTE/COUVERCLE**  
ROUND PLATE/CASSEROLE LID  
BOL/PLATO RONDO PAN  
12,5 CM - 4 IN<sup>15/16</sup>

230972  
**BOL COCOTTE**  
ROUND CASSEROLE  
BOL COCOTTE  
14 CM - 5 IN<sup>1/2</sup> - 50 CL - 16 OZ<sup>15/16</sup>

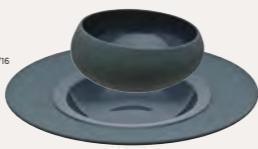

230969  
**ASSIETTE GOURMET GRAND BASSIN**  
SHALLOW BOWL W/WIDE ROUND RIM  
PLATO GOURMET HONDO FONDO GRANDE  
EXT : 26 CM - 10 IN<sup>1/4</sup>  
INT : 14 CM - 5 IN<sup>1/2</sup>

230968  
**ASSIETTE GOURMET PETIT BASSIN**  
SHALLOW BOWL W/WIDE ROUND RIM  
PLATO GOURMET REDONDO FONDO PEQUEÑO  
EXT : 23 CM - 9 IN<sup>1/16</sup>  
INT : 11,5 CM - 4 IN<sup>1/2</sup>

**DUNE - BEIGE DUNE - BEIS DUNA**



230921  
**ASSIETTE PLATE**  
ROUND DINNER PLATE  
PLATO REDONDO  
EXT : 29 CM - 11 IN<sup>7/16</sup>  
INT : 25,5 CM - 10 IN<sup>1/16</sup>

230920  
**ASSIETTE PLATE**  
ROUND DINNER PLATE  
PLATO REDONDO  
EXT : 26 CM - 10 IN<sup>1/4</sup>  
INT : 22 CM - 8 IN<sup>15/16</sup>

230919  
**ASSIETTE PLATE**  
ROUND DINNER PLATE  
PLATO REDONDO  
EXT : 23 CM - 9 IN<sup>1/16</sup>  
INT : 19,5 CM - 7 IN<sup>1/16</sup>



230918  
**ASSIETTE À PAIN**  
ROUND BREAD & BUTTER PLATE  
PLATO DE PAN  
EXT : 14 CM - 5 IN<sup>1/2</sup>  
INT : 10 CM - 3 IN<sup>5/16</sup>



230922  
**ASSIETTE CREUSE**  
ROUND DEEP PLATE  
PLATO HONDO  
EXT : 20 CM - 7 IN<sup>7/8</sup>  
INT : 16,5 CM - 6 IN<sup>1/2</sup>



230928  
**ASSIETTE /COUVERCLE**  
ROUND PLATE/CASSEROLE LID  
BOL/PLATO RONDO PAN  
12,5 CM - 4 IN<sup>15/16</sup>

230927  
**BOL COCOTTE**  
ROUND CASSEROLE  
BOL COCOTTE  
14 CM - 5 IN<sup>1/2</sup> - 50 CL - 16 OZ<sup>15/16</sup>



230924  
**ASSIETTE GOURMET GRAND BASSIN**  
SHALLOW BOWL W/WIDE ROUND RIM  
PLATO GOURMET HONDO FONDO GRANDE  
EXT : 26 CM - 10 IN<sup>1/4</sup>  
INT : 14 CM - 5 IN<sup>1/2</sup>

230923  
**ASSIETTE GOURMET PETIT BASSIN**  
SHALLOW BOWL W/WIDE ROUND RIM  
PLATO GOURMET REDONDO FONDO PEQUEÑO  
EXT : 23 CM - 9 IN<sup>1/16</sup>  
INT : 11,5 CM - 4 IN<sup>1/2</sup>

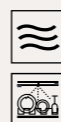

©Patrick ROUGERAU



ACCESSOIRES - ACCESSORIES - ACCESORIOS

NEW

**SALADIER**  
BOWL  
BOL  
28 CM - 11 IN



235223



235222

NEW

**PLANCHE**  
BOARD  
PLANCHA  
25 X 13,5 CM  
9 IN<sup>3/16</sup> X 5 IN<sup>5/16</sup>



237206



234949



234948

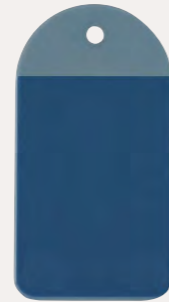

234950

**BOL BISEAUTÉ**  
**COCOTTE**  
SLANTED RIM BOWL  
BOL BISEADO COCOTTE  
7,3 CM - 2 IN<sup>7/8</sup>  
7 CL - 2 OZ<sup>3/8</sup>



236553



230956



230925



230942



230970



230908

NEW

**ONYX**  
ONYX  
ONYX

**ARGILE VERTE**  
GREEN CLAY  
ARCILLA VERDE

**DUNE**  
BEIGE DUNE  
BEIS DUNA

**BASALTE**  
BASALT BROWN  
BASALTO

**BLEU DE ROCHE**  
BLUE STONE  
AZUL DE ROCA

**ROSE SABLE**  
PINK SAND  
ROSA ARENA

CAFÉTERIE - TEATIME - TÉ CAFÉ

**TASSE À ESPRESSO**  
ESPRESSO CUP  
TAZA DE ESPRESSO  
11 CL - 3 OZ<sup>3/4</sup>



236557



230960



230929



230946



230974



230912

**TASSE À THÉ**  
COFFEE/TEA CUP  
TAZA DE TÉ  
20 CL - 6 OZ<sup>3/4</sup>



236559



230962



230931



230948



230976



230914

**MUG À THÉ**  
TEA MUG  
MUG  
38 CL - 12 OZ<sup>7/8</sup>



230961



230930



230947



230975



230913

NEW

**ONYX**  
ONYX  
ONYX

**ARGILE VERTE**  
GREEN CLAY  
ARCILLA VERDE

**DUNE**  
BEIGE DUNE  
BEIS DUNA

**BASALTE**  
BASALT BROWN  
BASALTO

**BLEU DE ROCHE**  
BLUE STONE  
AZUL DE ROCA

**ROSE SABLE**  
PINK SAND  
ROSA ARENA



©Patrick ROUGEREAU



Alldaydining

BAHIA

Grès  
Stoneware - Arenisca



**PIERRE DE LAVE - LAVA STONE - PIEDRA DE LAVA**



194455  
**ASSIETTE DE PRÉSENTATION**  
PRESENTATION PLATE, COUPE  
PLATO PRESENTACIÓN  
31,5 CM - 12 IN<sup>3/8</sup>

194454  
**ASSIETTE PLATE**  
DINNER PLATE, COUPE  
PLATO REDONDO  
28 CM - 11 IN

194453  
**ASSIETTE DESSERT**  
DESSERT/SALAD PLATE, COUPE  
PLATO REDONDO  
21 CM - 8 IN<sup>1/4</sup>



230092  
**ASSIETTE À PAIN**  
BREAD & BUTTER PLATE, COUPE  
PLATO DE PAN  
16 CM - 6 IN<sup>5/16</sup>



234455  
**COUPE RONDE**  
ROUND CUP  
BOL  
25 CM - 9 IN<sup>13/16</sup>



194452  
**ASSIETTE CALOTTE**  
SALAD/CEREAL PLATE  
PLATO HONDO  
21 CM - 8 IN<sup>1/4</sup>



194462  
**SALADIER**  
SALAD BOWL, DEEP  
ENSALADERA  
24 CM - 9 IN<sup>7/16</sup>  
H : 8 CM - 3 IN<sup>3/16</sup>



194457  
**COUPE/CALOTTE**  
SALAD/CEREAL PLATE, DEEP  
BOL  
17,7 CM - 6 IN<sup>5/16</sup>  
H : 5,5 CM - 2 IN<sup>3/16</sup>



194456  
**BOL À DEJEUNER**  
SOUP/BREAKFAST BOWL  
BOL DESAYUNO  
14 CM - 58 CL  
5 IN<sup>1/2</sup> - 19 OZ<sup>5/8</sup>



194458  
**COUPELLE**  
SMALL BOWL, CUP  
BOL PEQUEÑO  
10 CM - 3 IN<sup>15/16</sup>  
H : 6 CM - 2 IN<sup>3/8</sup>



194459  
**TASSE À CAFÉ**  
DEMITASSE CUP  
TAZA DE CAFÉ  
11,5 CL - 3 OZ<sup>7/8</sup>



230093  
**TASSE À THÉ**  
TEA CUP  
TAZA DE TÈ  
25 CL - 8 OZ<sup>7/16</sup>



194461  
**MUG À THÉ**  
MUG  
TÈ MUG  
33 CL - 11 OZ<sup>5/16</sup>

194460  
**SOUCOUBE À CAFÉ**  
DEMITASSE SAUCER  
ESPRESSO CAFÉ  
12,5 CM - 4 IN<sup>15/16</sup>

230094  
**SOUCOUBE À THÉ**  
DEMITASSE/TEA SAUCER  
PLATO TÈ  
15 CM - 5 OZ<sup>7/8</sup>

**KAOLIN - CAOLÍN**



184088  
**ASSIETTE DE PRÉSENTATION**  
PRESENTATION PLATE, COUPE  
PLATO PRESENTACIÓN  
31,5 CM - 12 IN<sup>3/8</sup>

184077  
**ASSIETTE PLATE**  
DINNER PLATE, COUPE  
PLATO REDONDO  
28 CM - 11 IN

184078  
**ASSIETTE DESSERT**  
DESSERT/SALAD PLATE, COUPE  
PLATO ILANO  
21 CM - 8 IN<sup>1/4</sup>



209092  
**ASSIETTE À PAIN**  
BREAD & BUTTER PLATE, COUPE  
PLATO DE PAN  
16 CM - 6 IN<sup>5/16</sup>



234449  
**COUPE RONDE**  
ROUND CUP  
BOL  
25 CM - 9 IN<sup>13/16</sup>



184079  
**ASSIETTE CALOTTE**  
SALAD/CEREAL PLATE  
PLATO HONDO  
21 CM - 8 IN<sup>1/4</sup>



184087  
**SALADIER**  
SALAD BOWL, DEEP  
ENSALADERA  
24 CM - 9 IN<sup>7/16</sup>  
H : 8 CM - 3 IN<sup>3/16</sup>



184086  
**COUPE/CALOTTE**  
SALAD/CEREAL PLATE, DEEP  
BOL  
17,7 CM - 6 IN<sup>5/16</sup>  
H : 5,5 CM - 2 IN<sup>3/16</sup>



184084  
**BOL À DEJEUNER**  
SOUP/BREAKFAST BOWL  
BOL DESAYUNO  
14 CM - 58 CL  
5 IN<sup>1/2</sup> - 19 OZ<sup>5/8</sup>



184085  
**COUPELLE**  
SMALL BOWL, CUP  
BOL PEQUEÑO  
10 CM - 3 IN<sup>15/16</sup>  
H : 6 CM - 2 IN<sup>3/8</sup>



184081  
**TASSE À CAFÉ**  
DEMITASSE CUP  
TAZA DE CAFÉ  
11,5 CL - 3 OZ<sup>7/8</sup>



230163  
**TASSE À THÉ**  
TEA CUP  
TAZA DE TÈ  
25 CL - 8 OZ<sup>7/16</sup>



184083  
**MUG À THÉ**  
MUG  
TÈ MUG  
33 CL - 11 OZ<sup>5/16</sup>

184082  
**SOUCOUBE À CAFÉ**  
DEMITASSE SAUCER  
ESPRESSO CAFÉ  
12,5 CM - 4 IN<sup>15/16</sup>

230164  
**SOUCOUBE À THÉ**  
DEMITASSE/TEA SAUCER  
PLATO TÈ  
15 CM - 5 OZ<sup>7/8</sup>



©Patrick ROUGEREAU  
Restaurant Cabane



**BLEU GALET - BLUE - AZUL**



**225342 ASSIETTE DE PRÉSENTATION**  
PRESENTATION PLATE, COUPE  
PLATO PRESENTACIÓN  
31,5 CM - 12 IN<sup>3/8</sup>

**225343 ASSIETTE PLATE**  
DINNER PLATE, COUPE  
PLATO REDONDO  
28 CM - 11 IN

**225344 ASSIETTE DESSERT**  
DESSERT/SALAD PLATE, COUPE  
PLATO ILANO  
21 CM - 8 IN<sup>1/4</sup>

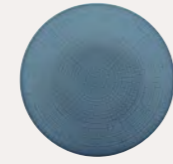

**225353 ASSIETTE À PAIN**  
BREAD & BUTTER PLATE, COUPE  
PLATO DE PAN  
16 CM - 6 IN<sup>5/16</sup>



**225345 ASSIETTE CALOTTE**  
SALAD/CEREAL PLATE  
PLATO HONDO  
21 CM - 8 IN<sup>1/4</sup>



**225347 COUPE/CALOTTE**  
SALAD/CEREAL PLATE, DEEP  
BOL  
17,7 CM - 6 IN<sup>15/16</sup>  
H : 5,5 CM - 2 IN<sup>3/16</sup>



**225349 SALADIER**  
SALAD BOWL, DEEP  
ENSALADERA  
24 CM - 9 IN<sup>7/16</sup>  
H : 8 CM - 3 IN<sup>3/8</sup>



**225346 COUELLE**  
SMALL BOWL, CUP  
BOL PEQUEÑO  
10 CM - 3 IN<sup>15/16</sup>  
H : 6 CM - 2 IN<sup>3/8</sup>



**225351 TASSE À CAFÉ**  
DEMITASSE CUP  
TAZA DE CAFÉ  
11,5 CL - 3 OZ<sup>7/8</sup>

**225352 SOUCOUBE À CAFÉ**  
DEMITASSE SAUCER  
ESPRESSO CAFÉ  
12,5 CM - 4 IN<sup>15/16</sup>



**230167 TASSE À THÉ**  
TEA CUP  
TAZA DE TÈ  
25 CL - 8 OZ<sup>7/16</sup>

**230168 SOUCOUBE À THÉ**  
DEMITASSE/TEA SAUCER  
PLATO TÈ  
15 CM - 5 OZ<sup>7/8</sup>

**TERRE D'OMBRE - TAUPE - TIERRA DE SOMBRA**



**184101 ASSIETTE DE PRÉSENTATION**  
PRESENTATION PLATE, COUPE  
PLATO PRESENTACIÓN  
31,5 CM - 12 IN<sup>3/8</sup>

**184090 ASSIETTE PLATE**  
DINNER PLATE, COUPE  
PLATO REDONDO  
28 CM - 11 IN

**184091 ASSIETTE DESSERT**  
DESSERT/SALAD PLATE, COUPE  
PLATO ILANO  
21 CM - 8 IN<sup>1/4</sup>



**209093 ASSIETTE À PAIN**  
BREAD & BUTTER PLATE, COUPE  
PLATO DE PAN  
16 CM - 6 IN<sup>5/16</sup>



**184092 ASSIETTE CALOTTE**  
SALAD/CEREAL PLATE  
PLATO HONDO  
21 CM - 8 IN<sup>1/4</sup>



**234451 COUPE RONDE**  
ROUND CUP  
BOL  
25 CM - 9 IN<sup>13/16</sup>



**184100 SALADIER**  
SALAD BOWL, DEEP  
ENSALADERA  
24 CM - 9 IN<sup>7/16</sup>  
H : 8 CM - 3 IN<sup>3/8</sup>



**184099 COUPE/CALOTTE**  
SALAD/CEREAL PLATE, DEEP  
BOL  
17,7 CM - 6 IN<sup>15/16</sup>  
H : 5,5 CM - 2 IN<sup>3/16</sup>



**184097 BOL À DEJEUNER**  
SOUP/BREAKFAST BOWL  
BOL DESAYUNO  
14 CM - 5,8 CL  
5 IN<sup>1/2</sup> - 19 OZ<sup>5/8</sup>



**184098 COUELLE**  
SMALL BOWL, CUP  
BOL PEQUEÑO  
10 CM - 3 IN<sup>15/16</sup>  
H : 6 CM - 2 IN<sup>3/8</sup>



**184094 TASSE À CAFÉ**  
DEMITASSE CUP  
TAZA DE CAFÉ  
11,5 CL - 3 OZ<sup>7/8</sup>

**184095 SOUCOUBE À CAFÉ**  
DEMITASSE SAUCER  
ESPRESSO CAFÉ  
12,5 CM - 4 IN<sup>15/16</sup>



**230165 TASSE À THÉ**  
TEA CUP  
TAZA DE TÈ  
25 CL - 8 OZ<sup>7/16</sup>

**230166 SOUCOUBE À THÉ**  
DEMITASSE/TEA SAUCER  
PLATO TÈ  
15 CM - 5 OZ<sup>7/8</sup>



**184096 MUG À THÉ**  
MUG  
TÈ MUG  
33 CL - 11 OZ<sup>3/16</sup>



©Thurid's Gastronomie Magazine - Pascal Lathes  
Chef Christophe Tuloup - Restaurant Teredoe



**VERT SHISHO - SHISHO GREEN - VERDE SHISHO**



**ROUGE PIMENT - RED CHILI - ROJO PIMIENTO**



**CRISTAUX DE SEL - SALT WHITE - CRISTALES DE SAL**



**BLEU INDIGO - INDIGO BLUE - AZUL AÑIL**



**ASSIETTE À PARTAGER RONDE**  
ROUND SHARED PLATE  
PLATO PARA COMPARTIR  
20 CM - 7 IN<sup>7/8</sup>

**ASSIETTE PLATE RONDE**  
ROUND DINNER PLATE  
PLATO REDONDO  
26 CM - 10 IN<sup>1/4</sup>

**COUPELLE RONDE**  
ROUND SMALL BOWL  
BOL PEQUEÑO  
12,5 CM - 4 IN<sup>15/16</sup>  
33 CL - 11 OZ<sup>1/16</sup>

**GRANDES ASSIETTES CREUSES RONDRES**  
ROUND LARGE DEEP PLATES  
GRANDE PLATO REDONDO  
22,5 CM - 8 IN<sup>7/8</sup>  
1L - 33 OZ<sup>13/16</sup>

**BOL**  
BOWL  
BOL  
19 CM - 7 IN<sup>1/2</sup>  
1,1 L - 37 OZ<sup>1/16</sup>



©Patrick ROUGEREAU

Alldaydining

**MONDO**

Grès  
Stoneware - Arenisca





---

## CAFÉTERIE

---

Le thé et le café sont des univers où le plaisir des sens est décuplé par le plaisir esthétique. Pour rendre ces instants de dégustation uniques, DEGRENNE propose une large sélection de tasses et accessoires. Collection iconique de la marque depuis 1953, redécouvrez Salam et réunissez tous les éléments pour maîtriser l'Art du Thé.

---

### TEATIME

---

Drinking tea and coffee is a sensory delight heightened by the sheer aesthetic pleasure of the experience. DEGRENNE offers a wide range of cups and accessories to make tea and coffee drinking a unique experience. An iconic DEGRENNE collection since 1953 - why not seize the opportunity to rediscover Salam and gather together the essentials needed to be skilled in the art of tea.

---

### TÉ - CAFÉ

---

El Té y el Café son universos en los que el placer de los sentidos se potencia con el placer estético. Para hacer que esos momentos de degustación sean únicos, DEGRENNE propone una amplia selección de tazas y accesorios. Colección única de la marca desde 1953, redescubra Salam y reúna todos los elementos para dominar el arte del té.





---

## REVISITER UNE ICÔNE

---

Créée en 1953, la théière Salam est le produit emblématique de la marque DEGRENNE. La finesse de la porcelaine alliée à l'éclat de la cloche sublime l'instant thé. Grâce à sa cloche tapissée d'une feutrine, **le thé conserve une température optimale deux fois plus longtemps que dans une théière classique.** Un procédé astucieux qui permet au thé de déployer toute la subtilité de ses saveurs au fil de la dégustation.

---

### REVISIT AN ICON

---

Created in 1953, Salam teapot is the iconic product of DEGRENNE. The finesse of porcelain combined with the radiance of the outer body enhances the tea experience. With its inner lining of thin felt, **the tea inside is kept at its optimum temperature for twice as long as in a regular teapot.** This is a clever trick to ensure that the tea is infused with all the subtlety of its flavours as the tasting progresses.

---

### VOLVER A EXPLORAR UN ICONO

---

Creada en 1953, la tetera Salam es el producto emblemático de la marca DEGRENNE. La finura de la porcelana combinada con el brillo del cuerpo de la tetera sublima el instante del té. Gracias a su cuerpo tapizado con fieltro, **el té conserva una temperatura óptima el doble de tiempo que una tetera clásica.** Este ingenioso proceso permite que el té despliegue toda la sutilidad de sus aromas a lo largo de la degustación.



**SALAM BLANCHE - WHITE - BLANCO**



211990 **THÉIÈRE 8 TASSES**  
TEA POT 8 CUPS  
TETERA 8 TAZAS  
130 CL - 43 OZ<sup>15/16</sup>

211989 **THÉIÈRE 6 TASSES**  
TEA POT 6 CUPS  
TETERA 6 TAZAS  
100 CL - 33 OZ<sup>13/16</sup>

211988 **THÉIÈRE 4 TASSES**  
TEA POT 4 CUPS  
TETERA 4 TAZAS  
70 CL - 23 OZ<sup>11/16</sup>

211987 **THÉIÈRE 2 TASSES**  
TEA POT 2 CUPS  
TETERA 2 TAZAS  
35 CL - 11 OZ<sup>13/16</sup>



189949 **CORPS THÉIÈRE 8 TASSES**  
TEA POT 8 CUPS WITHOUT LID  
CUERPO TETERA 8 TAZAS  
130 CL - 43 OZ<sup>15/16</sup>

189948 **CORPS THÉIÈRE 6 TASSES**  
TEA POT 6 CUPS WITHOUT LID  
CUERPO TETERA 6 TAZAS  
100 CL - 33 OZ<sup>13/16</sup>

189947 **CORPS THÉIÈRE 4 TASSES**  
TEA POT 4 CUPS WITHOUT LID  
CUERPO TETERA 4 TAZAS  
70 CL - 23 OZ<sup>11/16</sup>

189946 **CORPS THÉIÈRE 2 TASSES**  
TEA POT 2 CUPS WITHOUT LID  
CUERPO TETERA 2 TAZAS  
35 CL - 11 OZ<sup>13/16</sup>

**SALAM NOIRE - BLACK - NEGRO**



211994 **THÉIÈRE 8 TASSES**  
TEA POT 8 CUPS  
TETERA 8 TAZAS  
130 CL - 43 OZ<sup>15/16</sup>

211993 **THÉIÈRE 6 TASSES**  
TEA POT 6 CUPS  
TETERA 6 TAZAS  
100 CL - 33 OZ<sup>13/16</sup>

216414 **THÉIÈRE 6 TASSES**  
TEA POT 6 CUPS  
TETERA 6 TAZAS  
100 CL - 33 OZ<sup>13/16</sup>

211992 **THÉIÈRE 4 TASSES**  
TEA POT 4 CUPS  
TETERA 4 TAZAS  
70 CL - 23 OZ<sup>11/16</sup>

216410 **4 THÉIÈRE TASSES**  
TEA POT 4 CUPS  
TETERA 4 TAZAS  
70 CL - 23 OZ<sup>11/16</sup>

211991 **THÉIÈRE 2 TASSES**  
TEA POT 2 CUPS  
TETERA 2 TAZAS  
35 CL - 11 OZ<sup>13/16</sup>

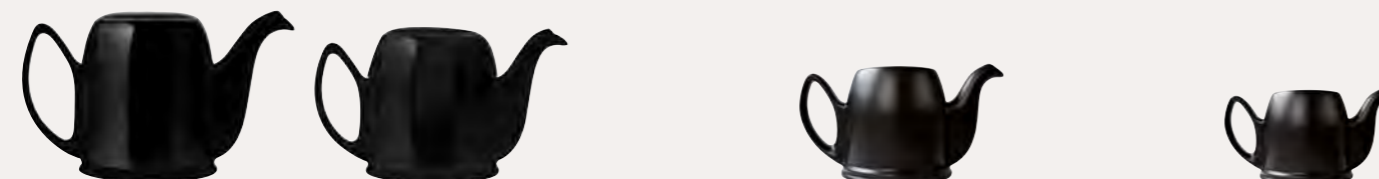

150447 **CORPS THÉIÈRE 8 TASSES**  
TEA POT 8 CUPS WITHOUT LID  
CUERPO TETERA 8 TAZAS  
130 CL - 43 OZ<sup>15/16</sup>

150456 **CORPS THÉIÈRE 6 TASSES**  
TEA POT 6 CUPS WITHOUT LID  
CUERPO TETERA 6 TAZAS  
100 CL - 33 OZ<sup>13/16</sup>

150455 **CORPS THÉIÈRE 4 TASSES**  
TEA POT 4 CUPS WITHOUT LID  
CUERPO TETERA 4 TAZAS  
70 CL - 23 OZ<sup>11/16</sup>

150450 **CORPS THÉIÈRE 2 TASSES**  
TEA POT 2 CUPS WITHOUT LID  
CUERPO TETERA 2 TAZAS  
35 CL - 11 OZ<sup>13/16</sup>

**SALAM COLOR**

**CLOCHE ALUMINIUM ZINC**  
ZINC ALUMINIUM LID - CAMPANA ZINC ALUMINIO

**CLOCHE ALUMINIUM BRONZE**  
BRONZE ALUMINIUM LID - CAMPANA BRONZE ALUMINIO

**CLOCHE ALUMINIUM BLEUE**  
BLUE ALUMINIUM LID - CAMPANA AZUL ALUMINIO



216416 **THÉIÈRE 6 TASSES**  
TEA POT 6 CUPS  
TETERA 6 TAZAS  
100 CL - 33 OZ<sup>13/16</sup>

216412 **THÉIÈRE 4 TASSES**  
TEA POT 4 CUPS  
TETERA 4 TAZAS  
70 CL - 23 OZ<sup>11/16</sup>

216415 **THÉIÈRE 6 TASSES**  
TEA POT 6 CUPS  
TETERA 6 TAZAS  
100 CL - 33 OZ<sup>13/16</sup>

216411 **THÉIÈRE 4 TASSES**  
TEA POT 4 CUPS  
TETERA 4 TAZAS  
70 CL - 23 OZ<sup>11/16</sup>

225359 **THÉIÈRE 6 TASSES**  
TEA POT 6 CUPS  
TETERA 6 TAZAS  
100 CL - 33 OZ<sup>13/16</sup>

225358 **THÉIÈRE 4 TASSES**  
TEA POT 4 CUPS  
TETERA 4 TAZAS  
70 CL - 23 OZ<sup>11/16</sup>

**CLOCHE INOX DORÉ**  
GOLD STAINLESS STEEL LID - CAMPANA DORADO INOX



234217 **THÉIÈRE 6 TASSES**  
TEA POT 6 CUPS  
TETERA 6 TAZAS  
100 CL - 33 OZ<sup>13/16</sup>

234216 **THÉIÈRE 4 TASSES**  
TEA POT 4 CUPS  
TETERA 4 TAZAS  
70 CL - 23 OZ<sup>11/16</sup>

**ACCESSOIRES - ACCESSORIES - ACCESORIOS**

**INFUSEUR**  
STAINLESS STEEL FILTER  
FILTRO TETERA



147992 **2 TASSES**  
2 CUPS - 2 TAZAS

147994 **4 TASSES**  
4 CUPS - 4 TAZAS

147993 **6/8 TASSES**  
6/8 CUPS - 6/8 TAZAS

**FEUTRE NOIR ISOLANT POUR THÉIÈRE**  
BLACK TEA POT FELT  
FIELTRO NEGRO AISLANTE TETERA

217130 **2 TASSES**  
2 CUPS - 2 TAZAS

217131 **4 TASSES**  
4 CUPS - 4 TAZAS

217132 **6 TASSES**  
6 CUPS - 6 TAZAS

217133 **8 TASSES**  
8 CUPS - 8 TAZAS

©Patrick ROUGEREAU



**BLANC - WHITE - BLANCO**



210946  
**TASSE À CAFÉ**  
DEMITASSE CUP  
TAZA DE CAFÉ  
11 CL - 3 OZ<sup>3/4</sup>

210947  
**TASSE À THÉ**  
COFFEE/TEA CUP  
TAZA DE TÉ  
25 CL - 8 OZ<sup>7/16</sup>

210948  
**TASSE DÉJEUNER**  
BREAKFAST CUP  
TAZA DESAYUNO  
42 CL - 14 OZ<sup>3/16</sup>

210949  
**MUG À THÉ**  
TEA MUG  
MUG  
38 CL - 12 OZ<sup>7/16</sup>

210950  
**SOUCOUBE CAFÉ/THÉ**  
DEMITASSE/COFFEE/TEA SAUCER  
PLATO CAFÉ/TÉ  
16 CM - 6 IN<sup>5/16</sup>

**GRIS PERLE - LIGHT GREY - GRIS PERLA**



230145  
**TASSE À CAFÉ**  
DEMITASSE CUP  
TAZA DE CAFÉ  
11 CL - 3 OZ<sup>3/4</sup>

230146  
**TASSE À THÉ**  
COFFEE/TEA CUP  
TAZA DE TÉ  
25 CL - 8 OZ<sup>7/16</sup>

230147  
**TASSE DÉJEUNER**  
BREAKFAST CUP  
TAZA DESAYUNO  
42 CL - 14 OZ<sup>3/16</sup>

230148  
**MUG À THÉ**  
TEA MUG  
MUG  
38 CL - 12 OZ<sup>7/16</sup>

210951  
**SOUCOUBE DÉJEUNER/MUG**  
BREAKFAST/MUG SAUCER  
PLATO DESAYUNO/MUG  
18 CM - 7 IN<sup>1/16</sup>

**ROSE POUDRÉ - POWDER PINK - POLVO ROSA**

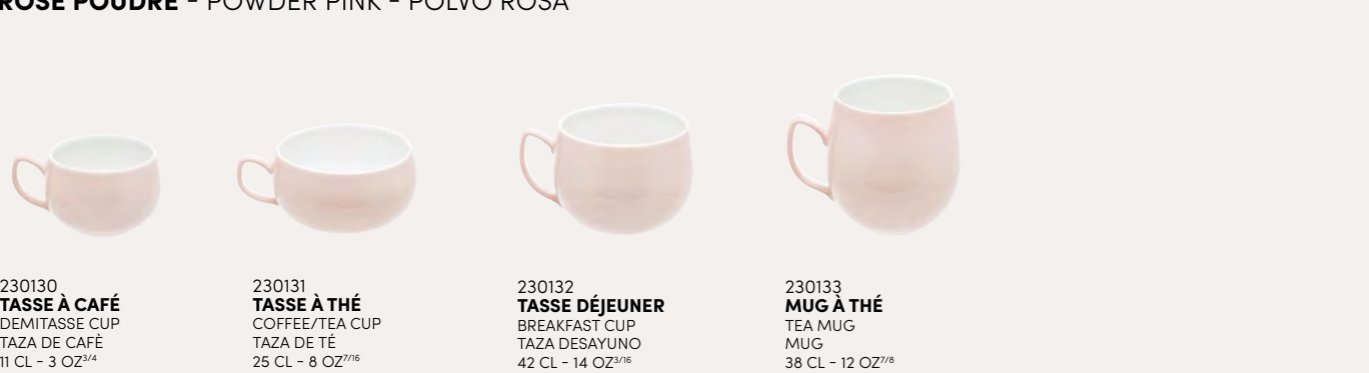

230130  
**TASSE À CAFÉ**  
DEMITASSE CUP  
TAZA DE CAFÉ  
11 CL - 3 OZ<sup>3/4</sup>

230131  
**TASSE À THÉ**  
COFFEE/TEA CUP  
TAZA DE TÉ  
25 CL - 8 OZ<sup>7/16</sup>

230132  
**TASSE DÉJEUNER**  
BREAKFAST CUP  
TAZA DESAYUNO  
42 CL - 14 OZ<sup>3/16</sup>

230133  
**MUG À THÉ**  
TEA MUG  
MUG  
38 CL - 12 OZ<sup>7/16</sup>

**ACCESSOIRES - ACCESSORIES - ACCESORIOS**



187276  
**SUCRIER**  
SUGAR BOWL  
AZUCARERO CON TAPA  
28 CL - 9 OZ<sup>7/16</sup>

150475  
**SUCRIER**  
SUGAR BOWL  
AZUCARERO CON TAPA  
28 CL - 9 OZ<sup>7/16</sup>

187283  
**CORPS SUCRIER**  
SUGAR BOWL WITHOUT LID  
AZUCARERO

150469  
**CORPS SUCRIER**  
SUGAR BOWL WITHOUT LID  
AZUCARERO

187277  
**CRÉMIER**  
CREAMER, JUG  
LECHERA  
15 CL - 5 OZ<sup>1/16</sup>

150485  
**CRÉMIER**  
CREAMER, JUG  
LECHERA  
15 CL - 5 OZ<sup>1/16</sup>

© Patrick ROUGEREAU

Le bibe d'alcool est dangereux pour la santé  
Degraine promoter responsible drinking and discourage alcohol misuse  
El bibe de alcohol es peligroso para la salud

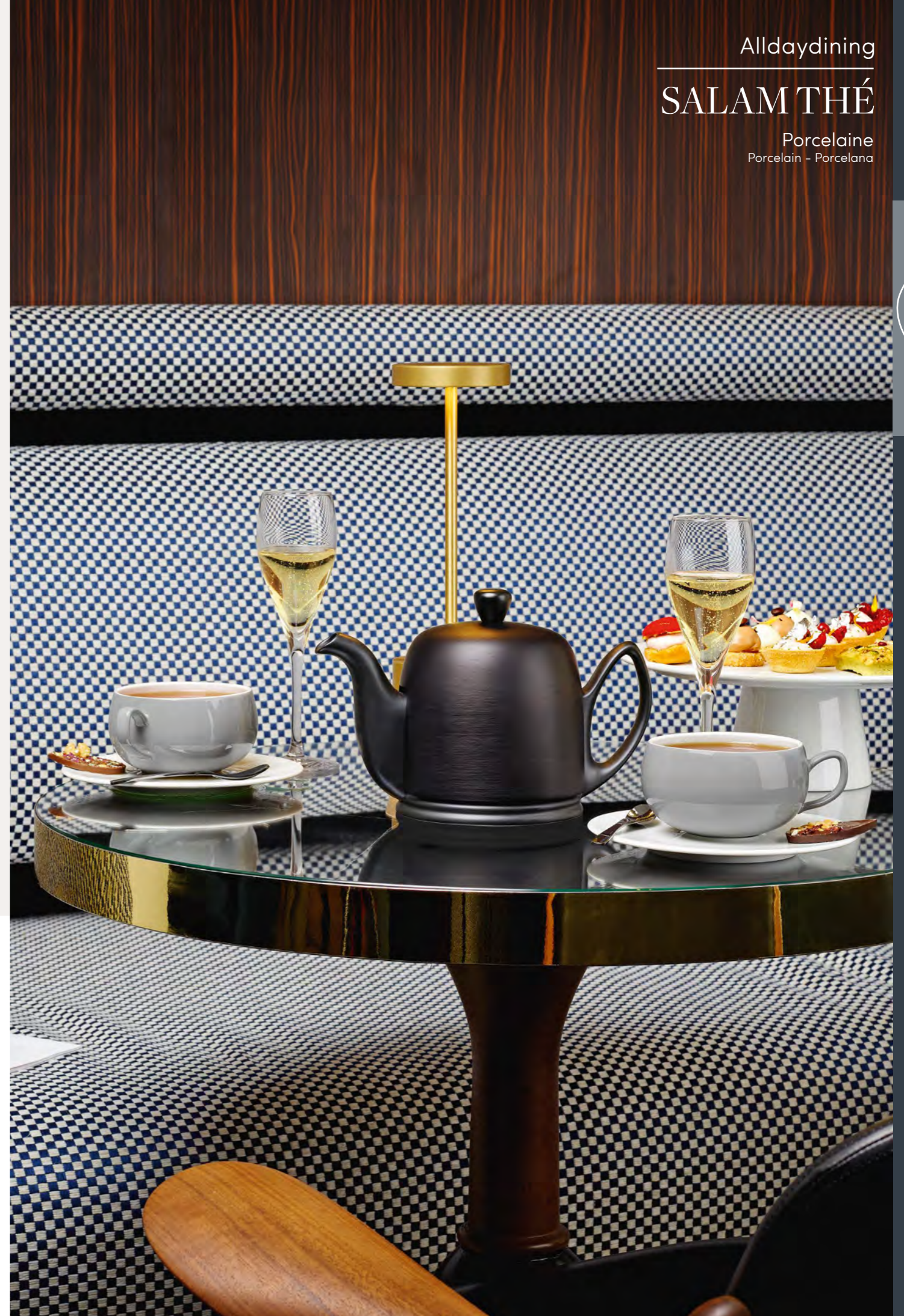

**COLLECTION L**



227828  
**TASSE ESPRESSO**  
DEMITASSE CUP  
ESPRESSO TAZA  
10 CL - 3 OZ<sup>1/8</sup>

227831  
**SOUCOUPE ESPRESSO**  
DEMITASSE SAUCER  
ESPRESSO PLATO  
12,5 CM - 4 IN<sup>5/16</sup>



227829  
**TASSE LUNGO**  
COFFEE/TEA CUP  
LUNGO TAZA  
25 CL - 8 OZ<sup>7/16</sup>

227832  
**SOUCOUPE LUNGO**  
COFFEE/TEA SAUCER  
LUNGO PLATO  
15,8 CM - 6 IN<sup>1/4</sup>

**COLLECTION L FRAGMENT**



227828  
**TASSE ESPRESSO**  
DEMITASSE CUP  
ESPRESSO TAZA  
10 CL - 3 OZ<sup>1/8</sup>

227849  
**SOUCOUPE ESPRESSO**  
DEMITASSE SAUCER  
ESPRESSO PLATO  
12,6 CM - 4 IN<sup>5/16</sup>



227829  
**TASSE LUNGO**  
COFFEE/TEA CUP  
LUNGO TAZA  
25 CL - 8 OZ<sup>7/16</sup>

227850  
**SOUCOUPE LUNGO**  
COFFEE/TEA SAUCER  
LUNGO PLATO  
15,8 CM - 6 IN<sup>1/4</sup>

**COLLECTION L COUTURE**



227828  
**TASSE ESPRESSO**  
DEMITASSE CUP  
ESPRESSO TAZA  
10 CL - 3 OZ<sup>1/8</sup>

237404  
**SOUCOUPE ESPRESSO**  
DEMITASSE SAUCER  
ESPRESSO PLATO  
12,6 CM - 4 IN<sup>5/16</sup>



227829  
**TASSE LUNGO**  
COFFEE/TEA CUP  
LUNGO TAZA  
25 CL - 8 OZ<sup>7/16</sup>

237405  
**SOUCOUPE LUNGO**  
COFFEE/TEA SAUCER  
LUNGO PLATO  
15,8 CM - 6 IN<sup>1/4</sup>

**COLLECTION L PERLES DE ROSÉE**



227828  
**TASSE ESPRESSO**  
DEMITASSE CUP  
ESPRESSO TAZA  
10 CL - 3 OZ<sup>1/8</sup>

233928  
**SOUCOUPE ESPRESSO**  
DEMITASSE SAUCER  
ESPRESSO PLATO  
12,6 CM - 4 IN<sup>5/16</sup>



227829  
**TASSE LUNGO**  
COFFEE/TEA CUP  
LUNGO TAZA  
25 CL - 8 OZ<sup>7/16</sup>

233929  
**SOUCOUPE LUNGO**  
COFFEE/TEA SAUCER  
LUNGO PLATO  
15,8 CM - 6 IN<sup>1/4</sup>

**NEWPORT Porcelaine – Porcelain – Porcelana**



207756  
**TASSE ESPRESSO**  
DEMITASSE CUP  
ESPRESSO TAZA  
10 CL - 3 OZ<sup>1/8</sup>

207759  
**SOUCOUPE ESPRESSO**  
DEMITASSE SAUCER  
ESPRESSO PLATO  
12,5 CM - 4 IN<sup>5/16</sup>



207757  
**TASSE LUNGO**  
COFFEE/TEA CUP  
LUNGO TAZA  
20 CL - 6 OZ<sup>3/4</sup>

207760  
**SOUCOUPE LUNGO**  
COFFEE/TEA SAUCER  
LUNGO PLATO  
15,8 CM - 5 IN<sup>7/8</sup>



207758  
**TASSE DÉJEUNER**  
BREAKFAST CUP  
TAZA DESAYUNO  
40 CL - 13 OZ<sup>1/2</sup>

207761  
**SOUCOUPE DÉJEUNER**  
BREAKFAST SAUCER  
PLATO DESAYUNO  
18 CM - 7 IN<sup>7/8</sup>



207756  
**TASSE ESPRESSO**  
DEMITASSE CUP  
ESPRESSO TAZA  
10 CL - 3 OZ<sup>1/8</sup>

223406  
**SOUCOUPE ESPRESSO**  
DEMITASSE SAUCER  
ESPRESSO PLATO  
12,5 CM - 4 IN<sup>5/16</sup>



207757  
**TASSE LUNGO**  
COFFEE/TEA CUP  
LUNGO TAZA  
20 CL - 6 OZ<sup>3/4</sup>

223407  
**SOUCOUPE LUNGO**  
COFFEE/TEA SAUCER  
LUNGO PLATO  
15 CM - 5 IN<sup>7/8</sup>



207763  
**VERSEUSE**  
COFFEE/TEA POT  
CAFETERA/TETERA  
40 CL - 13 OZ<sup>1/2</sup>



207764  
**VERSEUSE**  
COFFEE/TEA POT  
CAFETERA/TETERA  
80 CL - 27 OZ<sup>1/16</sup>



207762  
**CRÉMIER**  
CREAM JUG  
LECHERA  
10 CL - 3 OZ<sup>3/8</sup>



**COUVERCLES VERSEUSES**  
LIDS FOR TEA POTS  
TAPAS CAFETERAS

210911 210912  
6,6 CM - 2 IN<sup>5/8</sup> 8,4 CM - 3 IN<sup>5/16</sup>  
40 CL - 13 OZ<sup>1/2</sup> 80 CL - 27 OZ<sup>1/16</sup>



**NEWPORT P.184-185**



Visuel non contractuel ©Julie ANSAU

**CAFÉTERIE - TEATIME - TÉ CAFÉ**







207766  
**TASSE À ESPRESSO**  
ESPRESSO CUP  
ESPRESSO DE TAZA  
6 CL - 2 OZ

208948  
**TASSE À CAFÉ**  
DEMITASSE CUP  
TAZA DE CAFÉ  
11 CL - 3 OZ<sup>3/4</sup>

207767  
**TASSE À THÉ/LUNGO**  
COFFEE/TEA CUP  
LUNGO DE TAZA  
20 CL - 6 OZ<sup>3/4</sup>

207768  
**TASSE À DÉJEUNER**  
BREAKFAST CUP  
TAZA DESAYUNO  
48 CL - 16 OZ<sup>1/4</sup>

207765  
**MUG**  
MUG, LARGE  
MUG  
50 CL - 16 OZ<sup>15/16</sup>

209189  
**MUG**  
MUG  
MUG  
30 CL - 10 OZ<sup>7/8</sup>

161025  
**SOUCOUPE À CAFÉ/ESPRESSO**  
DEMITASSE/ESPRESSO SAUCER  
ESPRESSO DE PLATO  
15 CM - 5 IN<sup>7/8</sup>

161028  
**SOUCOUPE À THÉ/LUNGO**  
COFFEE/TEA SAUCER  
LUNGO DE PLATO  
18 CM - 7 IN<sup>7/8</sup>

161034  
**SOUCOUPE À DÉJEUNER**  
BREAKFAST SAUCER  
PLATO DESAYUNO  
21 CM - 8 IN<sup>3/4</sup>

BAHIA Grés – Stoneware – Arenisca

**TASSE À ESPRESSO**  
ESPRESSO CUP  
TAZA DE ESPRESSO  
11 CL - 3 OZ<sup>3/4</sup>



236557    230974    230929    230946    230960    230912

**TASSE À THÉ**  
COFFEE/TEA CUP  
TAZA DE TÉ  
20 CL - 6 OZ<sup>3/4</sup>



236559    230976    230931    230948    230962    230914

**MUG À THÉ**  
TEA MUG  
MUG  
38 CL - 12 OZ<sup>7/8</sup>



230975    230930    230947    230961    230913

**NEW**

**ONYX**  
ONYX  
ONYX

**BLEU DE ROCHE**  
BLUE STONE  
AZUL DE ROCA

**DUNE**  
BEIGE DUNE  
BEIS DUNA

**BASALTE**  
BASALT BROWN  
BASALTO

**ARGILE VERTE**  
GREEN CLAY  
ARCILLA VERDE

**ROSE SABLE**  
PINK SAND  
ROSA ARENA



**MODULO NATURE** Grés – Stoneware – Arenisca



194459 **TASSE À CAFÉ**  
DEMITASSE CUP  
TAZA DE CAFÉ  
11,5 CL - 3 OZ<sup>7/8</sup>

194460 **SOUCOUE À CAFÉ**  
DEMITASSE SAUCER  
ESPRESSO CAFÉ  
12,5 CM - 4 IN<sup>15/16</sup>



230093 **TASSE À THÉ**  
TEA CUP  
TAZA DE TÈ  
25 CL - 8 OZ<sup>7/16</sup>

230094 **SOUCOUE À THÉ**  
DEMITASSE/TEA SAUCER  
PLATO TÉ  
15 CM - 5 OZ<sup>7/8</sup>



194461 **MUG À THÉ**  
MUG  
TÈ MUG  
33 CL - 11 OZ<sup>3/16</sup>



184081 **TASSE À CAFÉ**  
DEMITASSE CUP  
TAZA DE CAFÉ  
11,5 CL - 3 OZ<sup>7/8</sup>

184082 **SOUCOUE À CAFÉ**  
DEMITASSE SAUCER  
ESPRESSO CAFÉ  
12,5 CM - 4 IN<sup>15/16</sup>



230163 **TASSE À THÉ**  
TEA CUP  
TAZA DE TÈ  
25 CL - 8 OZ<sup>7/16</sup>

230164 **SOUCOUE À THÉ**  
DEMITASSE/TEA SAUCER  
PLATO TÉ  
15 CM - 5 OZ<sup>7/8</sup>



184083 **MUG À THÉ**  
MUG  
TÈ MUG  
33 CL - 11 OZ<sup>3/16</sup>



225351 **TASSE À CAFÉ**  
DEMITASSE CUP  
TAZA DE CAFÉ  
11,5 CL - 3 OZ<sup>7/8</sup>

225352 **SOUCOUE À CAFÉ**  
DEMITASSE SAUCER  
ESPRESSO CAFÉ  
12,5 CM - 4 IN<sup>15/16</sup>



230167 **TASSE À THÉ**  
TEA CUP  
TAZA DE TÈ  
25 CL - 8 OZ<sup>7/16</sup>

230168 **SOUCOUE À THÉ**  
DEMITASSE/TEA SAUCER  
PLATO TÉ  
15 CM - 5 OZ<sup>7/8</sup>



184094 **TASSE À CAFÉ**  
DEMITASSE CUP  
TAZA DE CAFÉ  
11,5 CL - 3 OZ<sup>7/8</sup>

184095 **SOUCOUE À CAFÉ**  
DEMITASSE SAUCER  
ESPRESSO CAFÉ  
12,5 CM - 4 IN<sup>15/16</sup>



230165 **TASSE À THÉ**  
TEA CUP  
TAZA DE TÈ  
25 CL - 8 OZ<sup>7/16</sup>

230166 **SOUCOUE À THÉ**  
DEMITASSE/TEA SAUCER  
PLATO TÉ  
15 CM - 5 OZ<sup>7/8</sup>

**API** Porcelaine – Porcelain – Porcelana



207131 **ASSIETTE PLATE RECTANGLE 6 COMPARTIMENTS**  
RECTANGULAR DINNER PLATE  
6 COMPARTMENTS  
PLATO RECTANGULAR/6 COMPARTIMENTOS  
27X18 CM - 10 IN<sup>5/8</sup> X 7 IN<sup>1/16</sup>



207133 **SOUCOUE RECTANGULAIRE**  
RECTANGULAR PLATE/ SAUCER  
PLATO RECTANGULAR  
27X9 CM - 10 IN<sup>5/8</sup> X 3 IN<sup>9/16</sup>

Alldaydining  
**CAFÉTERIE -  
TEATIME - TÉ CAFÉ**





## COUVERTS

Les ateliers DEGRENNE donnent forme aux majestueuses bobines d'acier inoxydable et transforment la matière brute en couverts. Les couverts DEGRENNE bénéficient d'un **savoir-faire unique** et se caractérisent par une **ergonomie et une résistance exceptionnelle**. Faciles d'entretien, ils répondent aux critères les plus exigeants de **qualité, de fonctionnalité et d'esthétique** : la qualité du design et le soin apporté aux finitions font de chacun de nos couverts de **véritables pièces d'orfèvre de style classique ou contemporain**. Créé en collaboration avec des chefs ou en laissant libre cours à l'imagination de nos designers, aux lignes sobres ou plus élaborées, **chaque modèle DEGRENNE trouve sa place à table**.

### FLATWARE

DEGRENNE'S workshops shape the impressive reels of stainless steel and transform the raw material into cutlery. We use our **unique expertise** to create our cutlery, which is characterized by being extraordinarily **easy to use and sturdy**. DEGRENNE cutlery is easy to look after and meets the most stringent **quality, functionality and appearance criteria**. The design quality and painstaking finishes make each of our items of cutlery **true pieces of classic or contemporary silverware**. DEGRENNE cutlery is designed in partnership with chefs or by giving our designers free rein. Some items have simple lines, while others are more elaborate, but **every DEGRENNE design takes pride of place on a table**.

### CUBIERTOS

Los talleres DEGRENNE dan forma a las majestuosas bobinas de acero inoxidable y transforman la materia bruta en cubiertos. Los cubiertos DEGRENNE se benefician de un **saber hacer único** y se caracterizan por una **ergonomía y una resistencia excepcional**. Fáciles de mantener, responden a los criterios más exigentes de **calidad, de funcionalidad y de estética** : La calidad del diseño y el cuidado aportado a los acabados hacen que cada uno de nuestros cubiertos sea una **verdadera pieza de orfebrería de estilo clásico o contemporáneo**. Creado en colaboración con chefs o dando rienda suelta a la imaginación de nuestros diseñadores, con líneas sobrias o más elaboradas, **cada modelo DEGRENNE encuentra su lugar en la mesa**.

FUSE MIROIR P. 118 - 119





# COLLECTIONS DESIGN

XY BLACK MIROIR  
195039 - FOURCHETTE MISE EN BOUCHE - COCKTAIL FORK - TENEDOR PARA APERITIVO P. 102-103





205559  
**FOURCHETTE DE TABLE**  
TABLE FORK  
TENEDOR DE MESA  
21,3 CM - 8 IN<sup>3/8</sup>



181109  
**CUILLÈRE À MOKA**  
DEMI TASSE SPOON  
CUCHARA DE MOKA  
11 CM - 4 IN<sup>1/16</sup>



193776  
**COUTEAU DE TABLE MONOBLOC LAME SCIE**  
TABLE KNIFE SOLID HANDLE SERRATED  
CUCHILLO DE MESA HOJA SIERRA  
23,3 CM - 9 IN<sup>3/16</sup>



190018  
**CUILLÈRE À SODA**  
ICED TEA SPOON  
CUCHARA DE SODA/HELADO  
19 CM - 7 IN<sup>1/2</sup>



205560  
**CUILLÈRE DE TABLE**  
TABLE/PASTA SPOON  
CUCHARA DE MESA  
20,5 CM - 8 IN<sup>1/16</sup>



181119  
**FOURCHETTE MISE EN BOUCHE**  
COCKTAIL FORK  
TENEDOR PARA APERITIVO  
15,5 CM - 6 IN<sup>1/8</sup>



205561  
**CUILLÈRE À SOUPE ANGLAISE**  
BOUILLON SPOON, ROUND  
CUCHARA DE CONSOMÉ  
18,5 CM - 7 IN<sup>5/16</sup>



181120  
**SPATULE MISE EN BOUCHE**  
COCKTAIL SPATULA  
ESPÁTULA PARA APERITIVO  
15,5 CM - 6 IN<sup>1/8</sup>



205567  
**CUILLÈRE GOURMANDE**  
DESSERT / SOUP SPOON, OVAL  
CUCHARA DE POSTRE  
18,6 CM - 7 IN<sup>5/16</sup>



181121  
**CUILLÈRE MISE EN BOUCHE**  
COCKTAIL SPOON  
CUCHARA PARA APERITIVO  
11,6 CM - 4 IN<sup>3/16</sup>



205566  
**FOURCHETTE GOURMANDE**  
DESSERT / SALAD FORK  
TENEDOR DE POSTRE  
18,6 CM - 7 IN<sup>5/16</sup>



190424  
**FOURCHETTE À HUITRES**  
OYSTER FORK  
TENEDOR DE OSTRAS  
14,5 CM - 5 IN<sup>1/16</sup>



181111  
**COUTEAU À DESSERT MONOBLOC LAME UNIE**  
DESSERT KNIFE SOLID HANDLE  
CUCHILLO DE POSTRE HOJA LISA  
20,6 CM - 8 IN<sup>1/8</sup>



181114  
**FOURCHETTE DE SERVICE**  
SERVING FORK  
TENEDOR DE SERVICIO/ENSALADA  
26 CM - 10 IN<sup>1/4</sup>



181112  
**TARTINEUR**  
BUTTER SPREADER  
ESPÁTULIN PARA MANTEQUILLA  
16 CM - 6 IN<sup>5/16</sup>



181113  
**CUILLÈRE DE SERVICE**  
SERVING SPOON  
CUCHARA DE SERVICIO/ENSALADA  
26 CM - 10 IN<sup>1/4</sup>



205563  
**FOURCHETTE À POISSON**  
FISH FORK  
TENEDOR DE PESCADO  
20 CM - 7 IN<sup>7/8</sup>



181122  
**SPATULE DE SERVICE**  
SERVING SPATULA  
ESPÁTULA DE SERVICIO/ENSALADA  
25 CM - 9 IN<sup>13/16</sup>



205564  
**SPATULE GOURMET**  
GOURMET SPATULA  
ESPÁTULA GOURMET  
20,2 CM - 7 IN<sup>15/16</sup>



189999  
**SERVICE À SALADE**  
SALAD SERVING SET  
SET SERVICIO DE ENSALADA  
30 CM - 11 IN<sup>13/16</sup>



205565  
**FOURCHETTE GOURMET**  
GOURMET FORK  
TENEDOR GOURMET  
20 CM - 7 IN<sup>7/8</sup>

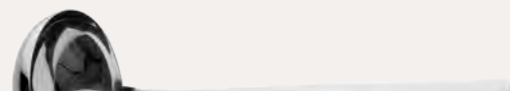

153193  
**LOUCHE**  
SOUP LADLE  
CAZO  
29,7 CM - 11 IN<sup>11/16</sup>



205562  
**CUILLÈRE À CAFÉ**  
COFFEE/TEA SPOON  
CUCHARA DE CAFÉ  
14,3 CM - 5 IN<sup>5/8</sup>



154606  
**LOUCHE À SAUCE**  
SAUCE LADLE  
CUCHARA SALSA  
18,5 CM - 7 IN<sup>5/16</sup>



Possibilité de personnalisation  
Bespoke options available - Posibilidad de personalización

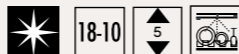

























@Patrick ROUGEREAU

XY BLACK MIROIR

- |   |   |  |  |
|---|---|--|--|
|    | 205568<br><b>FOURCHETTE DE TABLE</b><br>TABLE FORK<br>TENEDOR DE MESA<br>21,3 CM - 8 IN <sup>3/8</sup>  |    | 195034<br><b>CUILLÈRE À MOKA</b><br>DEMI TASSE SPOON<br>CUCHARA DE MOKA<br>11 CM - 4 IN <sup>1/16</sup>                  |
|     | 195028<br><b>COUTEAU DE TABLE MONOBLOC LAME SCIE</b><br>TABLE KNIFE SOLID HANDLE SERRATED<br>CUCHILLO DE MESA HOJA SIERRA<br>23,3 CM - 9 IN <sup>3/16</sup> |    | 196674<br><b>CUILLÈRE À SODA</b><br>ICED TEA SPOON<br>CUCHARA DE SODA/HELADO<br>19 CM - 7 IN <sup>1/2</sup>              |
|    | 205569<br><b>CUILLÈRE DE TABLE</b><br>TABLE/PASTA SPOON<br>CUCHARA DE MESA<br>20,5 CM - 8 IN <sup>1/16</sup>  |    | 195039<br><b>FOURCHETTE MISE EN BOUCHE</b><br>COCKTAIL FORK<br>TENEDOR PARA APERITIVO<br>15,5 CM - 6 IN <sup>1/8</sup>   |
|    | 200483<br><b>CUILLÈRE À SOUPE ANGLAISE</b><br>BOUILLON SPOON, ROUND<br>CUCHARA DE CONSOMÉ<br>18,5 CM - 7 IN <sup>5/16</sup>                                 |    | 195042<br><b>SPATULE MISE EN BOUCHE</b><br>COCKTAIL SPATULA<br>ESPÁTULA PARA APERITIVO<br>15,5 CM - 6 IN <sup>1/8</sup>  |
|    | 205575<br><b>CUILLÈRE GOURMANDE</b><br>DESSERT /SOUP SPOON, OVAL<br>CUCHARA DE POSTRE<br>18,6 CM - 7 IN <sup>5/16</sup>                                     |    | 195041<br><b>CUILLÈRE MISE EN BOUCHE</b><br>COCKTAIL SPOON<br>CUCHARA PARA APERITIVO<br>11,6 CM - 4 IN <sup>3/16</sup>   |
|   | 205574<br><b>FOURCHETTE GOURMANDE</b><br>DESSERT /SALAD FORK<br>TENEDOR DE POSTRE<br>18,6 CM - 7 IN <sup>5/16</sup>   |   | 196014<br><b>FOURCHETTE À HUITRES</b><br>OYSTER FORK<br>TENEDOR DE OSTRAS<br>14,1 CM - 5 IN <sup>3/16</sup>              |
|  | 195031<br><b>COUTEAU À DESSERT MONOBLOC LAME UNIE</b><br>DESSERT KNIFE SOLID HANDLE<br>CUCHILLO DE POSTRE HOJA LISA<br>20,6 CM - 8 IN <sup>1/8</sup>        |  | 199773<br><b>FOURCHETTE DE SERVICE</b><br>SERVING FORK<br>TENEDOR DE SERVICIO/ENSALADA<br>26 CM - 10 IN <sup>1/4</sup>   |
|  | 195036<br><b>TARTINEUR</b><br>BUTTER SPREADER<br>ESPATULIN PARA MANTEQUILLA<br>16 CM - 6 IN <sup>5/16</sup>   |  | 199774<br><b>CUILLÈRE DE SERVICE</b><br>SERVING SPOON<br>CUCHARA DE SERVICIO/ENSALADA<br>26 CM - 10 IN <sup>1/4</sup>    |
|  | 205571<br><b>FOURCHETTE À POISSON</b><br>FISH FORK<br>TENEDOR DE PESCADO<br>20 CM - 7 IN <sup>7/8</sup>   |  | 199769<br><b>SPATULE DE SERVICE</b><br>SERVING SPATULA<br>ESPÁTULA DE SERVICIO/ENSALADA<br>25 CM - 9 IN <sup>13/16</sup> |
|   | 205572<br><b>SPATULE GOURMET</b><br>GOURMET SPATULA<br>ESPÁTULA GOURMET<br>20,2 CM - 7 IN <sup>15/16</sup>  |  | 199771<br><b>SERVICE À SALADE</b><br>SALAD SERVING SET<br>SET SERVICIO DE ENSALADA<br>30 CM - 11 IN <sup>13/16</sup>     |
|  | 205573<br><b>FOURCHETTE GOURMET</b><br>GOURMET FORK<br>TENEDOR GOURMET<br>20 CM - 7 IN <sup>7/8</sup>   |  |  |
|  | 205570<br><b>CUILLÈRE À CAFÉ</b><br>COFFEE/TEA SPOON<br>CUCHARA DE CAFÉ<br>14,3 CM - 5 IN <sup>5/8</sup>  |  |  |







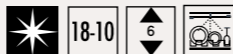















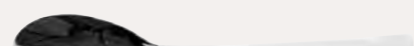

- |   |   |
|---|---|
|  <p>143770<br/><b>FOURCHETTE DE TABLE</b><br/>TABLE FORK<br/>TENEDOR DE MESA<br/>20,9 CM - 8 IN<sup>3/16</sup></p>  |  <p>181467<br/><b>COUTEAU À POISSON/GOURMET</b><br/>GOURMET FISH KNIFE<br/>CUCHILLO DE PESCADO<br/>20,1 CM - 7 IN<sup>5/16</sup></p>    |
|  <p>159484<br/><b>COUTEAU DE TABLE MONOBLOC LAME SCIE</b><br/>TABLE KNIFE SOLID HANDLE SERRATED<br/>CUCHILLO DE MESA HOJA SIERRA<br/>23,2 CM - 9 IN<sup>1/8</sup></p>         |  <p>143772<br/><b>CUILLÈRE À CAFÉ</b><br/>COFFEE/TEA SPOON<br/>CUCHARA DE CAFÉ<br/>14,9 CM - 5 IN<sup>7/8</sup></p>                     |
|  <p>208624<br/><b>COUTEAU DE TABLE MONOBLOC LAME SCIE</b><br/>TABLE KNIFE SOLID HANDLE SERRATED<br/>CUCHILLO DE MESA HOJA SIERRA<br/>23 CM - 9 IN<sup>1/8</sup></p>           |  <p>148855<br/><b>CUILLÈRE À MOKA</b><br/>DEMI TASSE SPOON<br/>CUCHARA DE MOKA<br/>11 CM - 4 IN<sup>5/16</sup></p>                      |
|  <p>159451<br/><b>COUTEAU À STEAK MONOBLOC LAME SCIE</b><br/>STEAK KNIFE SOLID HANDLE SERRATED<br/>CUCHILLO DE STEAK HOJA SIERRA<br/>23,5 CM - 9 IN<sup>1/4</sup></p>         |  <p>190018<br/><b>CUILLÈRE À SODA</b><br/>ICED TEA SPOON<br/>CUCHARA DE SODA/HELADO<br/>19 CM - 7 IN<sup>1/2</sup></p>                  |
|  <p>143767<br/><b>CUILLÈRE DE TABLE</b><br/>TABLE/PASTA SPOON<br/>CUCHARA DE MESA<br/>21,2 CM - 8 IN<sup>5/8</sup></p>  |  <p>143782<br/><b>FOURCHETTE À GÂTEAUX/COCKTAIL</b><br/>PASTRY/COCKTAIL FORK<br/>TENEDOR DE PASTEL<br/>14,9 CM - 5 IN<sup>7/8</sup></p> |
|  <p>148852<br/><b>CUILLÈRE À SOUPE ANGLAISE</b><br/>BOUILLON SPOON, ROUND<br/>CUCHARA DE CONSOMÉ<br/>17,1 CM - 6 IN<sup>3/4</sup></p>                                      |  <p>190424<br/><b>FOURCHETTE À HUITRES</b><br/>OYSTER FORK<br/>TENEDOR DE OSTRAS<br/>14,1 CM - 5 IN<sup>3/16</sup></p>                 |
|  <p>143801<br/><b>CUILLÈRE À DESSERT</b><br/>DESSERT /SOUP SPOON, OVAL<br/>CUCHARA DE POSTRE<br/>18,7 CM - 7 IN<sup>3/8</sup></p>  |  <p>197522<br/><b>FOURCHETTE DE SERVICE</b><br/>SERVING FORK<br/>TENEDOR DE SERVICIO/ENSALADA<br/>26,6 CM - 10 IN<sup>1/2</sup></p>   |
|  <p>143804<br/><b>FOURCHETTE À DESSERT</b><br/>DESSERT /SALAD FORK<br/>TENEDOR DE POSTRE<br/>18,4 CM - 7 IN<sup>1/4</sup></p>  |  <p>197523<br/><b>CUILLÈRE DE SERVICE</b><br/>SERVING SPOON<br/>CUCHARA DE SERVICIO/ENSALADA<br/>27 CM - 10 IN<sup>5/8</sup></p>      |
|  <p>159492<br/><b>COUTEAU À DESSERT MONOBLOC LAME UNIE</b><br/>DESSERT KNIFE SOLID HANDLE<br/>CUCHILLO DE POSTRE HOJA LISA<br/>20,4 CM - 8 IN<sup>1/16</sup></p>           |  <p>197525<br/><b>SERVICE À SALADE</b><br/>SALAD SERVING SET<br/>SET SERVICIO DE ENSALADA<br/>30 CM - 11 IN<sup>13/16</sup></p>       |
|  <p>208625<br/><b>COUTEAU À DESSERT MONOBLOC LAME SCIE</b><br/>DESSERT KNIFE SOLID HANDLE SERRATED<br/>CUCHILLO DE POSTRE HOJA SIERRA<br/>20,7 CM - 8 IN<sup>1/8</sup></p> |  <p>197527<br/><b>PELLE À TARTE MONOBLOC</b><br/>PASTRY SERVER SOLID HANDLE<br/>PALA PARA TARTA<br/>25,1 CM - 9 IN<sup>7/8</sup></p>  |
|  <p>181112<br/><b>TARTINEUR</b><br/>BUTTER SPREADER<br/>ESPATULÍN PARA MANTEQUILLA<br/>16 CM - 6 IN<sup>5/16</sup></p>   |  <p>153193<br/><b>LOUCHE</b><br/>SOUP LADLE<br/>CAZO<br/>29,7 CM - 11 IN<sup>11/16</sup></p>  |
|  <p>143790<br/><b>FOURCHETTE À POISSON</b><br/>FISH FORK<br/>TENEDOR DE PESCADO<br/>18,5 CM - 7 IN<sup>5/16</sup></p>  |  <p>154606<br/><b>LOUCHE À SAUCE</b><br/>SAUCE LADLE<br/>CAZO DE SALSA<br/>18,5 CM - 7 IN<sup>5/16</sup></p>                          |

Possibilité de personnalisation  
Bespoke options available - Posibilidad de personalización



©Patrick ROUGEREAU



- |   |   |  |  |
|---|---|--|--|
|    | <b>205540<br/>FOURCHETTE DE TABLE</b><br>TABLE FORK<br>TENEDOR DE MESA<br>20,9 CM - 8 IN <sup>3/16</sup>  |    | <b>205545<br/>COUTEAU À POISSON/GOURMET</b><br>GOURMET FISH KNIFE<br>CUCHILLO DE PESCADO<br>20,7 CM - 8 IN <sup>7/16</sup>     |
|     | <b>159484<br/>COUTEAU DE TABLE<br/>MONOBLOC LAME SCIE</b><br>TABLE KNIFE SOLID HANDLE SERRATED<br>CUCHILLO DE MESA HOJA SIERRA<br>23,2 CM - 9 IN <sup>1/8</sup>         |    | <b>205543<br/>CUILLÈRE À CAFÉ</b><br>COFFEE/TEA SPOON<br>CUCHARA DE CAFÉ<br>14 CM - 5 IN <sup>1/2</sup>                        |
|     | <b>208624<br/>COUTEAU DE TABLE<br/>MONOBLOC LAME SCIE</b><br>TABLE KNIFE SOLID HANDLE SERRATED<br>CUCHILLO DE MESA HOJA SIERRA<br>23 CM - 9 IN <sup>1/16</sup>          |    | <b>159512<br/>CUILLÈRE À MOKA</b><br>DEMI TASSE SPOON<br>CUCHARA DE MOKA<br>11,1 CM - 4 IN <sup>3/16</sup>                     |
|     | <b>159451<br/>COUTEAU À STEAK<br/>MONOBLOC LAME SCIE</b><br>STEAK KNIFE SOLID HANDLE SERRATED<br>CUCHILLO DE STEAK HOJA SIERRA<br>23,5 CM - 9 IN <sup>1/4</sup>         |    | <b>190018<br/>CUILLÈRE À SODA</b><br>ICED TEA SPOON<br>CUCHARA DE SODA/HELADO<br>19 CM - 7 IN <sup>1/2</sup>                   |
|    | <b>205541<br/>CUILLÈRE DE TABLE</b><br>TABLE/PASTA SPOON<br>CUCHARA DE MESA<br>20,9 CM - 8 IN <sup>1/4</sup>  |    | <b>205548<br/>FOURCHETTE À GÂTEAUX/COCKTAIL</b><br>PASTRY/COCKTAIL FORK<br>TENEDOR DE PASTEL<br>14,1 CM - 5 IN <sup>5/16</sup> |
|  | <b>205542<br/>CUILLÈRE À SOUPE ANGLAISE</b><br>BOUILLON SPOON, ROUND<br>CUCHARA DE CONSOMÉ<br>17,8 CM - 7 IN  |   | <b>190424<br/>FOURCHETTE À HUITRES</b><br>OYSTER FORK<br>TENEDOR DE OSTRAS<br>14,5 CM - 5 IN <sup>11/16</sup>                  |
|  | <b>205547<br/>CUILLÈRE À DESSERT</b><br>DESSERT /SOUP SPOON, OVAL<br>CUCHARA DE POSTRE<br>18,4 CM - 7 IN <sup>1/4</sup>   |  | <b>159501<br/>FOURCHETTE DE SERVICE</b><br>SERVING FORK<br>TENEDOR DE SERVICIO/ENSALADA<br>26 CM - 10 IN <sup>1/4</sup>        |
|  | <b>205546<br/>FOURCHETTE À DESSERT</b><br>DESSERT /SALAD FORK<br>TENEDOR DE POSTRE<br>18,4 CM - 7 IN <sup>1/4</sup>   |  | <b>159500<br/>CUILLÈRE DE SERVICE</b><br>SERVING SPOON<br>CUCHARA DE SERVICIO/ENSALADA<br>26 CM - 10 IN <sup>1/4</sup>         |
|  | <b>159492<br/>COUTEAU À DESSERT<br/>MONOBLOC LAME UNIE</b><br>DESSERT KNIFE SOLID HANDLE<br>CUCHILLO DE POSTRE HOJA LISA<br>20,4 CM - 8 IN <sup>1/16</sup>              |  | <b>159504<br/>SERVICE À SALADE</b><br>SALAD SERVING SET<br>SET SERVICIO DE ENSALADA<br>30 CM - 11 IN <sup>13/16</sup>          |
|  | <b>208625<br/>COUTEAU À DESSERT<br/>MONOBLOC LAME SCIE</b><br>DESSERT KNIFE SOLID HANDLE<br>SERRATED<br>CUCHILLO DE POSTRE HOJA SIERRA<br>20,7 CM - 8 IN <sup>1/8</sup> |  | <b>159490<br/>PELLE À TARTE MONOBLOC</b><br>PASTRY SERVER SOLID HANDLE<br>PALA PARA TARTA<br>26,2 CM - 10 IN <sup>1/4</sup>    |
|  | <b>154612<br/>COUTEAU À BEURRE<br/>MONOBLOC LAME UNIE</b><br>BUTTER KNIFE SOLID HANDLE<br>CUCHILLO DE MANTEQUILLA HOJA LISA<br>19,4 CM - 7 IN <sup>5/8</sup>            |  | <b>153193<br/>LOUCHE</b><br>SOUP LADLE<br>CAZO<br>29,7 CM - 11 IN <sup>11/16</sup>   |
|  | <b>205544<br/>FOURCHETTE À POISSON</b><br>FISH FORK<br>TENEDOR DE PESCADO<br>18,4 CM - 7 IN <sup>1/4</sup>  |  | <b>154606<br/>CUILLÈRE À SAUCE</b><br>SAUCE SPOON<br>CUCHARA DE SALSA<br>18,5 CM - 7 IN <sup>5/16</sup>                        |

Possibilité de personnalisation  
Bespoke options available - Posibilidad de personalización

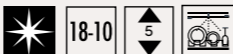

©Patrick ROUGEREAU







233011  
**FOURCHETTE DE TABLE**  
TABLE FORK  
TENEDOR DE MESA  
20,5 CM - 8 IN<sup>1/8</sup>



233013  
**COUPEAU DE TABLE MONOBLOC À BOUT POINTU LAME SCIE**  
TABLE KNIFE SOLID HANDLE POINTED BLADE SERRATED  
CUCHILLO DE MESA HOJA SIERRA  
23,3 CM - 9 IN<sup>3/16</sup>



233014  
**COUPEAU DE TABLE MONOBLOC À BOUT ROND LAME SCIE**  
TABLE KNIFE SOLID HANDLE ROUNDED BLADE SERRATED  
CUCHILLO DE MESA HOJA SIERRA  
23,3 CM - 9 IN<sup>3/16</sup>



229520  
**COUPEAU DE TABLE MANCHE ORFÈVRE LAME UNIE**  
TABLE KNIFE HOLLOW HANDLE  
CUCHILLO DE MESA ENMANGADO HOJA LISA  
23,3 CM - 9 IN<sup>3/16</sup>



233012  
**CUILLÈRE DE TABLE**  
TABLE/PASTA SPOON  
CUCHARA DE MESA  
20,5 CM - 8 IN<sup>1/8</sup>



233022  
**CUILLÈRE À SOUPE ANGLAISE**  
BOUILLON SPOON, ROUND  
CUCHARA DE CONSOMÉ  
18,5 CM - 7 IN<sup>5/16</sup>



233018  
**CUILLÈRE À DESSERT**  
DESSERT / SOUP SPOON, OVAL  
CUCHARA DE POSTRE  
18,5 CM - 7 IN<sup>5/16</sup>



233017  
**FOURCHETTE À DESSERT**  
DESSERT / SALAD FORK  
TENEDOR DE POSTRE  
18,5 CM - 7 IN<sup>5/16</sup>



233019  
**COUPEAU À DESSERT MONOBLOC À BOUT ROND LAME UNIE**  
DESSERT KNIFE SOLID HANDLE ROUNDED BLADE  
CUCHILLO DE POSTRE HOJA LISA  
20,9 CM - 8 IN<sup>3/4</sup>



233023  
**COUPEAU À BEURRE MONOBLOC LAME UNIE**  
BUTTER KNIFE SOLID HANDLE  
CUCHILLO DE MANTEQUILLA HOJA LISA  
17,5 CM - 6 IN<sup>7/8</sup>



233021  
**CUILLÈRE GOURMET**  
GOURMET SPOON  
CUCHARA PARA SALSA  
18,5 CM - 7 IN<sup>5/16</sup>



233015  
**CUILLÈRE À CAFÉ**  
COFFEE/TEA SPOON  
CUCHARA DE CAFÉ  
13,9 CM - 5 IN<sup>1/2</sup>



233016  
**CUILLÈRE À MOKA**  
DEMI TASSE SPOON  
CUCHARA DE MOKA  
11,7 CM - 4 IN<sup>5/8</sup>



233020  
**FOURCHETTE À GÂTEAUX/ COCKTAIL**  
PASTRY/COCKTAIL FORK  
TENEDOR DE PASTEL  
13,9 CM - 5 IN<sup>1/2</sup>



233024  
**FOURCHETTE DE SERVICE**  
SERVING FORK  
TENEDOR DE SERVICIO/ENSALADA  
26,3 CM - 10 IN<sup>3/8</sup>



233025  
**CUILLÈRE DE SERVICE**  
SERVING SPOON  
CUCHARA DE SERVICIO/ENSALADA  
26,3 CM - 10 IN<sup>3/8</sup>



Possibilité de personnalisation  
Bespoke options available - Posibilidad de personalización

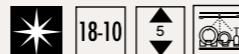

©Patrick POUGEREAU  
L'abus d'alcool est dangereux pour la santé.  
Dégrenerne promotes responsible drinking and discourages alcohol misuse.  
El abuso de alcohol es peligroso para la salud.



197507  
**FOURCHETTE DE TABLE**  
TABLE FORK  
TENEDOR DE MESA  
21,3 CM - 8 IN<sup>3/8</sup>



197509  
**COUPEAU DE TABLE MONOBLOC LAME SCIE**  
TABLE KNIFE SOLID HANDLE SERRATED  
CUCHILLO DE MESA HOJA SIERRA  
23,2 CM - 9 IN<sup>1/8</sup>



235481 **NEW**  
**COUPEAU DE TABLE MONOBLOC LAME SCIE**  
TABLE KNIFE SOLID HANDLE SERRATED  
CUCHILLO DE MESA HOJA SIERRA  
23,7 CM - 9 IN<sup>5/16</sup>



197521  
**COUPEAU À STEAK MONOBLOC LAME SCIE**  
STEAK KNIFE SOLID HANDLE SERRATED  
CUCHILLO DE STEAK HOJA SIERRA  
23,2 CM - 9 IN<sup>1/8</sup>



197506  
**CUILLÈRE DE TABLE**  
TABLE/PASTA SPOON  
CUCHARA DE MESA  
21,6 CM - 8 IN<sup>1/2</sup>



197518  
**CUILLÈRE À SOUPE ANGLAISE**  
BOUILLON SPOON, ROUND  
CUCHARA DE CONSOMÉ  
18,5 CM - 7 IN<sup>5/16</sup>



197512  
**CUILLÈRE À DESSERT**  
DESSERT/SOUP SPOON, OVAL  
CUCHARA DE POSTRE  
19,5 CM - 7 IN<sup>11/16</sup>



197511  
**FOURCHETTE À DESSERT**  
DESSERT/SALAD FORK  
TENEDOR DE POSTRE  
19,2 CM - 7 IN<sup>9/16</sup>



210629  
**COUPEAU À DESSERT MONOBLOC LAME SCIE**  
DESSERT KNIFE SOLID HANDLE SERRATED  
CUCHILLO DE POSTRE HOJA SIERRA  
20,9 CM - 8 IN<sup>3/16</sup>



235482 **NEW**  
**COUPEAU À DESSERT MONOBLOC LAME UNIE**  
DESSERT KNIFE SOLID HANDLE  
CUCHILLO DE POSTRE HOJA LISA  
21,3 CM - 8 IN<sup>3/8</sup>



197520  
**COUPEAU À BEURRE MONOBLOC LAME UNIE**  
BUTTER KNIFE SOLID HANDLE  
CUCHILLO PARA MANTEQUILLA HOJA LISA  
19,3 CM - 7 IN<sup>5/8</sup>



197514  
**FOURCHETTE À POISSON**  
FISH FORK  
TENEDOR DE PESCADO  
19,2 CM - 7 IN<sup>9/16</sup>



197515  
**COUPEAU À POISSON/GOURMET**  
GOURMET FISH KNIFE  
CUCHILLO DE PESCADO  
21,3 CM - 8 IN<sup>3/8</sup>



197508  
**CUILLÈRE À CAFÉ**  
COFFEE/TEA SPOON  
CUCHARA DE CAFÉ  
14,3 CM - 5 IN<sup>5/8</sup>



197510  
**CUILLÈRE À MOKA**  
DEMI TASSE SPOON  
CUCHARA DE MOKA  
11,7 CM - 4 IN<sup>5/8</sup>



190018  
**CUILLÈRE À SODA**  
ICED TEA SPOON  
CUCHARA DE SODA/HELADO  
19 CM - 7 IN<sup>1/2</sup>



197516  
**FOURCHETTE À GÂTEAUX/COCKTAIL**  
PASTRY/COCKTAIL FORK  
TENEDOR DE PASTEL  
13,9 CM - 5 IN<sup>1/2</sup>



190424  
**FOURCHETTE À HÙÎTRES**  
OYSTER FORK  
TENEDOR DE OSTRAS  
14,1 CM - 5 IN<sup>9/16</sup>



197522  
**FOURCHETTE DE SERVICE**  
SERVING FORK  
TENEDOR DE SERVICIO/ENSALADA  
26,6 CM - 10 IN<sup>1/2</sup>



197523  
**CUILLÈRE DE SERVICE**  
SERVING SPOON  
CUCHARA DE SERVICIO/ENSALADA  
27 CM - 10 IN<sup>5/8</sup>



197525  
**SERVICE À SALADE**  
SALAD SERVING SET  
SET SERVICIO DE ENSALADA  
30 CM - 11 IN<sup>13/16</sup>



197527  
**PELLE À TARTE MONOBLOC**  
PASTRY SERVER SOLID HANDLE  
PALA PARA TARTA  
25,1 CM - 9 IN<sup>7/8</sup>



153193  
**LOUCHE**  
SOUP LADLE  
CAZO  
29,7 CM - 11 IN<sup>11/16</sup>



154606  
**CUILLÈRE À SAUCE**  
SAUCE LADLE  
CAZO DE SALSA  
18,5 CM - 7 IN<sup>5/16</sup>

Possibilité de personnalisation  
Bespoke options available - Posibilidad de personalización

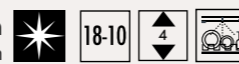

©Patrick ROUGEREAU  
Le but de tous ces produits est de promouvoir un usage responsable de l'alcool.  
Degreene promotes responsible drinking and discourages alcohol misuse.  
El abuso de alcohol es peligroso para la salud.





223482  
**FOURCHETTE DE TABLE**  
TABLE FORK  
TENEDOR DE MESA  
21,3 CM - 8 IN<sup>3/8</sup>



202995  
**COUTEAU DE TABLE MONOBLOC LAME SCIE**  
TABLE KNIFE SOLID HANDLE SERRATED  
CUCHILLO DE MESA HOJA SIERRA  
23,2 CM - 9 IN<sup>1/8</sup>



203017  
**COUTEAU À STEAK MONOBLOC LAME SCIE**  
STEAK KNIFE SOLID HANDLE SERRATED  
CUCHILLO DE STEAK HOJA SIERRA  
23,2 CM - 9 IN<sup>1/8</sup>



223481  
**CUILLÈRE DE TABLE**  
TABLE/PASTA SPOON  
CUCHARA DE MESA  
21,6 CM - 8 IN<sup>1/2</sup>



223491  
**CUILLÈRE À SOUPE ANGLAISE**  
BOUILLON SPOON, ROUND  
CUCHARA DE CONSOMÉ  
18,5 CM - 7 IN<sup>5/16</sup>



223486  
**CUILLÈRE À DESSERT**  
DESSERT/SOUP SPOON, OVAL  
CUCHARA DE POSTRE  
19,5 CM - 7 IN<sup>11/16</sup>



223485  
**FOURCHETTE À DESSERT**  
DESSERT/SALAD FORK  
TENEDOR DE POSTRE  
19,2 CM - 7 IN<sup>9/16</sup>



210630  
**COUTEAU À DESSERT MONOBLOC LAME SCIE**  
DESSERT KNIFE SOLID HANDLE SERRATED  
CUCHILLO DE POSTRE HOJA SIERRA  
20,9 CM - 8 IN<sup>3/16</sup>



203016  
**COUTEAU À BEURRE MONOBLOC LAME UNIE**  
BUTTER KNIFE SOLID HANDLE  
CUCHILLO PARA MANTEQUILLA HOJA LISA  
19,3 CM - 7 IN<sup>5/8</sup>



223487  
**FOURCHETTE À POISSON**  
FISH FORK  
TENEDOR DE PESCADO  
19,2 CM - 7 IN<sup>9/16</sup>



223488  
**COUTEAU À POISSON/GOURMET**  
GOURMET FISH KNIFE  
CUCHILLO DE PESCADO  
21,3 CM - 8 IN<sup>3/8</sup>



223483  
**CUILLÈRE À CAFÉ**  
COFFEE/TEA SPOON  
CUCHARA DE CAFÉ  
14,3 CM - 5 IN<sup>5/8</sup>



223484  
**CUILLÈRE À MOKA**  
DEMI TASSE SPOON  
CUCHARA DE MOKA  
11,7 CM - 4 IN<sup>5/8</sup>



223492  
**CUILLÈRE À SODA**  
ICED TEA SPOON  
CUCHARA DE SODA/HELADO  
18,9 CM - 7 IN<sup>7/16</sup>



223489  
**FOURCHETTE À GÂTEAUX/COCKTAIL**  
PASTRY/COCKTAIL FORK  
TENEDOR DE PASTEL  
13,9 CM - 5 IN<sup>1/2</sup>



223493  
**FOURCHETTE DE SERVICE**  
SERVING FORK  
TENEDOR DE SERVICIO/ENSALADA  
26,6 CM - 10 IN<sup>1/2</sup>



223494  
**CUILLÈRE DE SERVICE**  
SERVING SPOON  
CUCHARA DE SERVICIO/ENSALADA  
27 CM - 10 IN<sup>5/8</sup>



223496  
**SERVICE À SALADE**  
SALAD SERVING SET  
SET SERVICIO DE ENSALADA  
30 CM - 11 IN<sup>13/16</sup>



223497  
**PELLE À TARTE MONOBLOC**  
PASTRY SERVER SOLID HANDLE  
PALA PARA TARTA  
25,1 CM - 9 IN<sup>7/8</sup>



©Patrick ROUGEREAU



GUEST CUIVRE  
COPPER



230848  
**FOURCHETTE DE TABLE**  
TABLE FORK  
TENEDOR DE MESA  
21,3 CM - 8 IN<sup>3/8</sup>



230850  
**COUTEAU DE TABLE MONOBLOC LAME SCIE**  
TABLE KNIFE SOLID HANDLE SERRATED  
CUCHILLO DE MESA HOJA SIERRA  
23,2 CM - 9 IN<sup>1/8</sup>



230849  
**CUILLÈRE DE TABLE**  
TABLE/PASTA SPOON  
CUCHARA DE MESA  
21,6 CM - 8 IN<sup>1/2</sup>



230854  
**CUILLÈRE À DESSERT**  
DESSERT /SOUP SPOON, OVAL  
CUCHARA DE POSTRE  
19,5 CM - 7 IN<sup>11/16</sup>



230853  
**FOURCHETTE À DESSERT**  
DESSERT /SALAD FORK  
TENEDOR DE POSTRE  
19,2 CM - 7 IN<sup>9/16</sup>



230855  
**COUTEAU À DESSERT MONOBLOC LAME SCIE**  
DESSERT KNIFE SOLID HANDLE SERRATED  
CUCHILLO DE POSTRE HOJA SIERRA  
20,9 CM - 8 IN<sup>3/16</sup>



230851  
**CUILLÈRE À CAFÉ**  
COFFEE/TEA SPOON  
CUCHARA DE CAFE  
14,3 CM - 5 IN<sup>5/8</sup>



230852  
**CUILLÈRE À MOKA**  
DEMI TASSE SPOON  
CUCHARA DE MOKA  
11,7 CM - 4 IN<sup>5/8</sup>



©Patrick ROUGEREAU



217139  
**FOURCHETTE DE TABLE**  
TABLE FORK  
TENEDOR DE MESA  
21,3 CM - 8 IN<sup>3/8</sup>



217140  
**COUTEAU DE TABLE MONOBLOC LAME SCIE**  
TABLE KNIFE SOLID HANDLE SERRATED  
CUCHILLO DE MESA HOJA SIERRA  
23,2 CM - 9 IN<sup>1/8</sup>



230339  
**COUTEAU À STEAK MONOBLOC LAME SCIE**  
STEAK KNIFE SOLID HANDLE SERRATED  
CUCHILLO DE STEAK HOJA SIERRA  
23,2 CM - 9 IN<sup>1/8</sup>



217141  
**CUILLÈRE DE TABLE**  
TABLE/PASTA SPOON  
CUCHARA DE MESA  
21,6 CM - 8 IN<sup>1/2</sup>



217143  
**CUILLÈRE À DESSERT**  
DESSERT / SOUP SPOON, OVAL  
CUCHARA DE POSTRE  
19,5 CM - 7 IN<sup>11/16</sup>



217144  
**FOURCHETTE À DESSERT**  
DESSERT / SALAD FORK  
TENEDOR DE POSTRE  
19,2 CM - 7 IN<sup>5/16</sup>



217145  
**COUTEAU À DESSERT MONOBLOC LAME SCIE**  
DESSERT KNIFE SOLID HANDLE SERRATED  
CUCHILLO DE POSTRE HOJA SIERRA  
20,9 CM - 8 IN<sup>3/16</sup>



232307  
**TARTINEUR**  
BUTTER SPREADER  
ESPATULIN PARA MANTEQUILLA  
16 CM - 6 IN<sup>5/16</sup>



230411  
**FOURCHETTE À POISSON**  
FISH FORK  
TENEDOR DE PESCADO  
19,2 CM - 7 IN<sup>9/16</sup>



230412  
**COUTEAU POISSON/GOURMET**  
GOURMET/FISH KNIFE  
CUCHILLO DE PESCADO  
21,3 CM - 8 IN<sup>3/8</sup>



217142  
**CUILLÈRE À CAFÉ**  
COFFEE/TEA SPOON  
CUCHARA DE CAFÉ  
14,3 CM - 5 IN<sup>5/8</sup>



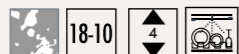

217146  
**CUILLÈRE À MOKA**  
DEMI TASSE SPOON  
CUCHARA DE MOKA  
11,7 CM - 4 IN<sup>5/8</sup>





©Patrick ROUGEREAU





- 

236700  
**FOURCHETTE DE TABLE**  
TABLE FORK  
TENEDOR DE MESA  
21,5 CM - 8 IN<sup>7/16</sup>
- 

236702  
**COUTEAU DE TABLE MONBLOC LAME SCIE**  
TABLE KNIFE SOLID HANDLE SERRATED  
CUCHILLO DE MESA HOJA SIERRA  
21,5 CM - 8 IN<sup>7/16</sup>
- 

236701  
**CUILLÈRE DE TABLE**  
TABLE/PASTA SPOON  
CUCHARA DE MESA  
21,5 CM - 8 IN<sup>7/16</sup>
- 

236726  
**CUILLÈRE À SOUPE ANGLAISE**  
BOUILLON SPOON, ROUND  
CUCHARA DE CONSOMÉ  
18,5 CM - 7 IN<sup>5/16</sup>
- 

236721  
**CUILLÈRE À DESSERT**  
DESSERT /SOUP SPOON, OVAL  
CUCHARA DE POSTRE  
19,1 CM - 7 IN<sup>1/2</sup>
- 

236719  
**FOURCHETTE À DESSERT**  
DESSERT /SALAD FORK  
TENEDOR DE POSTRE  
19,1 CM - 7 IN<sup>1/2</sup>
- 

236720  
**COUTEAU À DESSERT MONBLOC LAME UNIE**  
DESSERT KNIFE SOLID HANDLE  
CUCHILLO DE POSTRE HOJA LISA  
19,2 CM - 7 IN<sup>9/16</sup>
- 

236727  
**TARTINEUR**  
BUTTER SPREADER  
ESPATULÍN PARA MANTEQUILLA  
16,5 CM - 6 IN<sup>1/2</sup>
- 

236703  
**CUILLÈRE À CAFÉ**  
COFFEE/TEA SPOON  
CUCHARA DE CAFÉ  
15 CM - 5 IN<sup>7/8</sup>
- 

236722  
**CUILLÈRE À MOKA**  
DEMI TASSE SPOON  
CUCHARA DE MOKA  
11 CM - 4 IN<sup>9/16</sup>
- 

236724  
**FOURCHETTE DE SERVICE**  
SERVING FORK  
TENEDOR DE SERVICIO/ENSALADA  
26 CM - 10 IN<sup>1/4</sup>
- 

236723  
**CUILLÈRE DE SERVICE**  
SERVING SPOON  
CUCHARA DE SERVICIO/ENSALADA  
26 CM - 10 IN<sup>1/4</sup>

Possibilité de personnalisation  
Bespoke options available - Posibilidad de personalización

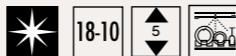

©Patrick ROUGEREAU  
L'abus d'alcool est dangereux pour la santé  
Degrè de responsabilité drinking and discourages alcohol misuse  
El abuso de alcohol es peligroso para la salud

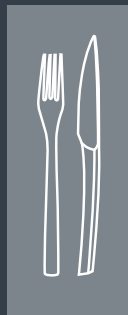

**NEW** FUSE MARTELÉ



236790  
**FOURCHETTE DE TABLE**  
TABLE FORK  
TENEDOR DE MESA  
21,5 CM - 8 IN<sup>7/8</sup>



236791  
**COUTEAU DE TABLE MONOBLOC LAME SCIE**  
TABLE KNIFE SOLID HANDLE SERRATED  
CUCHILLO DE MESA HOJA SIERRA  
21,5 CM - 8 IN<sup>7/8</sup>



236789  
**CUILLÈRE DE TABLE**  
TABLE/PASTA SPOON  
CUCHARA DE MESA  
21,5 CM - 8 IN<sup>7/8</sup>



236802  
**CUILLÈRE À SOUPE ANGLAISE**  
BOUILLON SPOON, ROUND  
CUCHARA DE CONSOMÉ  
18,5 CM - 7 IN<sup>5/8</sup>



236796  
**CUILLÈRE À DESSERT**  
DESSERT / SOUP SPOON, OVAL  
CUCHARA DE POSTRE  
19,1 CM - 7 IN<sup>7/2</sup>



236794  
**FOURCHETTE À DESSERT**  
DESSERT / SALAD FORK  
TENEDOR DE POSTRE  
19,1 CM - 7 IN<sup>7/2</sup>



236795  
**COUTEAU À DESSERT MONOBLOC LAME UNIE**  
DESSERT KNIFE SOLID HANDLE  
CUCHILLO DE POSTRE HOJA LISA  
19,2 CM - 7 IN<sup>9/16</sup>



236804  
**TARTINEUR**  
BUTTER SPREADER  
ESPATULIN PARA MANTEQUILLA  
16,5 CM - 6 IN<sup>1/2</sup>



236798  
**CUILLÈRE À CAFÉ**  
COFFEE/TEA SPOON  
CUCHARA DE CAFE  
15 CM - 5 IN<sup>7/8</sup>



236797  
**CUILLÈRE À MOKA**  
DEMI TASSE SPOON  
CUCHARA DE MOKA  
11 CM - 4 IN<sup>5/16</sup>



236806  
**PIC APÉRO**  
COCKTAIL PICK  
TENEDOR PARA APERITIVO  
15 CM - 5 IN<sup>1/8</sup>



236805  
**FOURCHETTE/PIQUE À ESCARGOTS/COCKTAIL**  
COCKTAIL, SNAIL FORK  
TENEDOR DE CARACOL/COCKTAIL  
15 CM - 5 IN<sup>7/8</sup>



236800  
**FOURCHETTE DE SERVICE**  
SERVING FORK  
TENEDOR DE SERVICIO/ENSALADA  
26 CM - 10 IN<sup>1/4</sup>



236799  
**CUILLÈRE DE SERVICE**  
SERVING SPOON  
CUCHARA DE SERVICIO/ENSALADA  
26 CM - 10 IN<sup>1/4</sup>



Possibilité de personnalisation  
Bespoke options available - Posibilidad de personalización

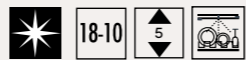

©Patrick ROUGEREAU



126355  
**FOURCHETTE DE TABLE**  
TABLE FORK  
TENEDOR DE MESA  
20,1 CM - 7 IN<sup>15/16</sup>



126358  
**CUILLÈRE À CAFÉ**  
COFFEE/TEA SPOON  
CUCHARA DE CAFÉ  
13,7 CM - 5 IN<sup>9/16</sup>



210731  
**COUTEAU DE TABLE MONOBLOC LAME SCIE**  
TABLE KNIFE SOLID HANDLE SERRATED  
CUCHILLO DE MESA HOJA SIERRA  
23,5 CM - 9 IN<sup>1/4</sup>



140852  
**CUILLÈRE À MOKA**  
DEMI TASSE SPOON  
CUCHARA DE MOKA  
11 CM - 4 IN<sup>5/16</sup>



207189  
**COUTEAU À STEAK MONOBLOC LAME SCIE**  
STEAK KNIFE SOLID HANDLE SERRATED  
CUCHILLO DE STEAK HOJA SIERRA  
23,6 CM - 9 IN<sup>5/16</sup>



189973  
**CUILLÈRE À SODA**  
ICED TEA SPOON  
CUCHARA DE SODA/HELADO  
19 CM - 7 IN<sup>1/2</sup>



126352  
**CUILLÈRE DE TABLE**  
TABLE/PASTA SPOON  
CUCHARA DE MESA  
20,3 CM - 8 IN



126383  
**FOURCHETTE À GÂTEAUX COCKTAIL**  
PASTRY/COCKTAIL FORK  
TENEDOR DE PASTEL  
13,7 CM - 5 IN<sup>9/16</sup>



140855  
**CUILLÈRE À SOUPE ANGLAISE**  
BOUILLON SPOON, ROUND  
CUCHARA DE CONSOMÉ  
17,9 CM - 7 IN<sup>1/16</sup>



189974  
**FOURCHETTE À HUITRES**  
OYSTER FORK  
TENEDOR DE OSTRAS  
14,1 CM - 5 IN<sup>9/16</sup>



126368  
**CUILLÈRE À DESSERT**  
DESSERT /SOUP SPOON, OVAL  
CUCHARA DE POSTRE  
17,8 CM - 7 IN



231218  
**FOURCHETTE DE SERVICE**  
SERVING FORK  
TENEDOR DE SERVICIO/ENSALADA  
26,6 CM - 10 IN<sup>1/2</sup>



126371  
**FOURCHETTE À DESSERT**  
DESSERT /SALAD FORK  
TENEDOR DE POSTRE  
17,7 CM - 6 IN<sup>5/16</sup>



231219  
**CUILLÈRE DE SERVICE**  
SERVING SPOON  
CUCHARA DE SERVICIO/ENSALADA  
26,6 CM - 10 IN<sup>1/2</sup>



210732  
**COUTEAU À DESSERT MONOBLOC LAME UNIE**  
DESSERT KNIFE SOLID HANDLE  
CUCHILLO DE POSTRE HOJA LISA  
20,7 CM - 8 IN<sup>1/8</sup>



231221  
**PELLE À TARTE MONOBLOC**  
PASTRY SERVER SOLID HANDLE  
PALA PARA TARTA  
25,2 CM - 9 IN<sup>15/16</sup>



189971  
**COUTEAU À BEURRE MONOBLOC LAME UNIE**  
BUTTER KNIFE SOLID HANDLE  
CUCHILLO DE MANTEQUILLA  
HOJA LISA  
18,9 CM - 7 IN<sup>7/16</sup>



231220  
**LOUCHE**  
SOUP LADLE  
CAZO  
29 CM - 11 IN<sup>7/16</sup>



126377  
**FOURCHETTE À POISSON**  
FISH FORK  
TENEDOR DE PESCADO  
17,7 CM - 6 IN<sup>15/16</sup>



181181  
**COUTEAU À POISSON/ GOURMET**  
GOURMET FISH KNIFE  
CUCHILLO DE PESCADO  
20,1 CM - 7 IN<sup>15/16</sup>



Possibilité de personnalisation  
Bespoke options available - Posibilidad de personalización

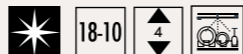

©Julie ANSIAU  
L'abus d'alcool est dangereux pour la santé.  
Il faut modérer sa consommation.  
Responsible drinking and discourages alcohol misuse.  
El abuso de alcohol es peligroso para la salud.





235927  
**FOURCHETTE DE TABLE**  
TABLE FORK  
TENEDOR DE MESA  
19,9 CM - 7 IN<sup>3/16</sup>



235930  
**COUTEAU DE TABLE MONOBLOC LAME SCIE**  
TABLE KNIFE SOLID HANDLE SERRATED  
CUCHILLO DE MESA HOJA SIERRA  
23,2 CM - 9 IN<sup>1/4</sup>



235928  
**CUILLÈRE DE TABLE**  
TABLE/PASTA SPOON  
CUCHARA DE MESA  
19,9 CM - 7 IN<sup>3/16</sup>



235938  
**CUILLÈRE À SOUPE ANGLAISE**  
BOUILLON SPOON, ROUND  
CUCHARA DE CONSOMÉ  
18,4 CM - 7 IN<sup>1/4</sup>



235934  
**CUILLÈRE À DESSERT**  
DESSERT/SOUP SPOON, OVAL  
CUCHARA DE POSTRE  
18,4 CM - 7 IN<sup>1/4</sup>



235933  
**FOURCHETTE À DESSERT**  
DESSERT/SALAD FORK  
TENEDOR DE POSTRE  
18,4 CM - 7 IN<sup>1/4</sup>



235935  
**COUTEAU À DESSERT MONOBLOC LAME SCIE**  
DESSERT KNIFE SOLID HANDLE SERRATED  
CUCHILLO DE POSTRE HOJA SIERRA  
20,9 CM - 8 IN<sup>3/16</sup>



235939  
**COUTEAU À BEURRE MONOBLOC LAME UNIE**  
BUTTER KNIFE SOLID HANDLE  
CUCHILLO DE MANTEQUILLA HOJA LISA  
16,5 CM - 6 IN<sup>1/2</sup>



235929  
**CUILLÈRE À CAFÉ**  
COFFEE/TEA SPOON  
CUCHARA DE CAFÉ  
13,9 CM - 5 IN<sup>1/2</sup>



235932  
**CUILLÈRE À MOKA**  
DEMI TASSE SPOON  
CUCHARA DE MOKA  
10,9 CM - 4 IN<sup>5/16</sup>



235937  
**FOURCHETTE À GÂTEAUX/ COCKTAIL**  
PASTRY/COCKTAIL FORK  
TENEDOR DE PASTEL  
14,1 CM - 5 IN<sup>9/16</sup>



231218  
**FOURCHETTE DE SERVICE**  
SERVING FORK  
TENEDOR DE SERVICIO/ENSALADA  
26,6 CM - 10 IN<sup>1/2</sup>



231219  
**CUILLÈRE DE SERVICE**  
SERVING SPOON  
CUCHARA DE SERVICIO/ENSALADA  
26,6 CM - 10 IN<sup>1/2</sup>



231221  
**PELLE À TARTE MONOBLOC**  
PASTRY SERVER SOLID HANDLE  
PALA PARA TARTA  
25,2 CM - 9 IN<sup>5/16</sup>



231220  
**LOUCHE**  
SOUP LADLE  
CAZO  
29 CM - 11 IN<sup>7/16</sup>





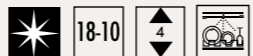





















Possibilité de personnalisation  
Bespoke options available - Posibilidad de personalización



© Patrick ROUGÉREAU

# ASTRÉE MIROIR

- |   |  |  |  |
|---|--|--|--|
|     | <b>153188<br/>FOURCHETTE DE TABLE</b><br>TABLE FORK<br>TENEDOR DE MESA<br>20,7 CM - 8 IN <sup>5/8</sup>  |    | <b>154609<br/>CUILLÈRE À MOKA</b><br>DEMI TASSE SPOON<br>CUCHARA DE MOKA<br>11,1 CM - 4 IN <sup>3/8</sup>  |
|     | <b>153196<br/>COUTEAU DE TABLE<br/>MONOBLOC LAME SCIE</b><br>TABLE KNIFE SOLID HANDLE SERRATED<br>CUCHILLO DE MESA HOJA SIERRA<br>23,5 CM - 9 IN <sup>1/4</sup>          |    | <b>190018<br/>CUILLÈRE À SODA</b><br>ICED TEA SPOON<br>CUCHARA DE SODA/HELADO<br>19 CM - 7 IN <sup>1/2</sup>                                       |
|     | <b>122418<br/>COUTEAU À STEAK<br/>MONOBLOC LAME SCIE</b><br>STEAK KNIFE SOLID HANDLE SERRATED<br>CUCHILLO DE STEAK HOJA SIERRA<br>22,1 CM - 8 IN <sup>11/16</sup>        |    | <b>197516<br/>FOURCHETTE À GÂTEAUX<br/>COCKTAIL</b><br>PASTRY/COCKTAIL FORK<br>TENEDOR DE PASTEL<br>13,9 CM - 5 IN <sup>1/2</sup>                  |
|    | <b>153185<br/>CUILLÈRE DE TABLE</b><br>TABLE/PASTA SPOON<br>CUCHARA DE MESA<br>20,7 CM - 8 IN <sup>5/8</sup>   |    | <b>190424<br/>FOURCHETTE À HÛÎTRES</b><br>OYSTER FORK<br>TENEDOR DE OSTRAS<br>14,1 CM - 5 IN <sup>9/16</sup>                                       |
|    | <b>184758<br/>CUILLÈRE À SOUPE ANGLAISE</b><br>BOUILLON SPOON, ROUND<br>CUCHARA DE CONSOMÉ<br>18,3 CM - 7 IN <sup>3/8</sup>  |    | <b>162728<br/>FOURCHETTE/PIQUE À<br/>ESCARGOTS/COCKTAIL</b><br>COCKTAIL/SNAIL FORK<br>TENEDOR DE CARACOL/COCKTAIL<br>10,8 CM - 4 IN <sup>1/4</sup> |
|   | <b>153209<br/>CUILLÈRE À DESSERT</b><br>DESSERT /SOUP SPOON, OVAL<br>CUCHARA DE POSTRE<br>18,6 CM - 7 IN <sup>5/16</sup>   |  | <b>162730<br/>CURETTE À CRUSTACÉS</b><br>SEAFOOD SCRAPER<br>RASQUETA PARA CANGREJO<br>19,1 CM - 7 IN <sup>1/2</sup>                                |
|  | <b>153212<br/>FOURCHETTE À DESSERT</b><br>DESSERT /SALAD FORK<br>TENEDOR DE POSTRE<br>18,6 CM - 7 IN <sup>5/16</sup>   |  | <b>197522<br/>FOURCHETTE DE SERVICE</b><br>SERVING FORK<br>TENEDOR DE SERVICIO/ENSALADA<br>26,6 CM - 10 IN <sup>1/2</sup>                          |
|   | <b>153200<br/>COUTEAU À DESSERT<br/>MONOBLOC LAME SCIE</b><br>DESSERT KNIFE SOLID HANDLE<br>SERRATED<br>CUCHILLO DE POSTRE HOJA SIERRA<br>21,1 CM - 8 IN <sup>5/16</sup> |  | <b>197523<br/>CUILLÈRE DE SERVICE</b><br>SERVING SPOON<br>CUCHARA DE SERVICIO/ENSALADA<br>27 CM - 10 IN <sup>5/8</sup>                             |
|  | <b>154612<br/>COUTEAU À BEURRE<br/>MONOBLOC LAME UNIE</b><br>BUTTER KNIFE SOLID HANDLE<br>CUCHILLO DE MANTEQUILLA<br>HOJA LISA<br>19,4 CM - 7 IN <sup>5/8</sup>          |  | <b>197525<br/>SERVICE À SALADE</b><br>SALAD SERVING SET<br>SET SERVICIO DE ENSALADA<br>30 CM - 11 IN <sup>13/16</sup>                              |
|  | <b>153203<br/>FOURCHETTE À POISSON</b><br>FISH FORK<br>TENEDOR DE PESCADO<br>18,6 CM - 7 IN <sup>5/16</sup>  |  | <b>197527<br/>PELLE À TARTE MONOBLOC</b><br>PASTRY SERVER SOLID HANDLE<br>PALA PARA TARTA<br>25,1 CM - 9 IN <sup>7/8</sup>                         |
|  | <b>153206<br/>COUTEAU À POISSON/<br/>GOURMET</b><br>GOURMET FISH KNIFE<br>CUCHILLO DE PESCADO<br>21,1 CM - 8 IN <sup>5/16</sup>  |  | <b>153193<br/>LOUCHE</b><br>SOUP LADLE<br>CAZO<br>29,7 CM - 11 IN <sup>13/16</sup>   |
|  | <b>153191<br/>CUILLÈRE À CAFÉ</b><br>COFFEE/TEA SPOON<br>CUCHARA DE CAFÉ<br>14,1 CM - 5 IN <sup>9/16</sup>   |  | <b>154606<br/>LOUCHE À SAUCE</b><br>SAUCE LADLE<br>CAZO PARA SALSA<br>18,5 CM - 7 IN <sup>9/16</sup>   |



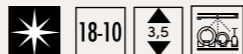

















Possibilité de personnalisation  
Bespoke options available - Posibilidad de personalización



©Patrick ROUGEREAU

















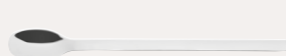





# ASTRÉE CISELÉ

- |   |   |  |  |
|---|---|--|--|
|     | <b>153998<br/>FOURCHETTE DE TABLE</b><br>TABLE FORK<br>TENEDOR DE MESA<br>20,7 CM - 8 IN <sup>5/8</sup>   |    | <b>154001<br/>CUILLÈRE À CAFÉ</b><br>COFFEE/TEA SPOON<br>CUCHARA DE CAFÉ<br>14,1 CM - 5 IN <sup>3/8</sup>                        |
|     | <b>154002<br/>COUTEAU DE TABLE<br/>MONOBLOC LAME SCIE</b><br>TABLE KNIFE SOLID HANDLE SERRATED<br>CUCHILLO DE MESA HOJA SIERRA<br>23,5 CM - 9 IN <sup>1/4</sup>         |    | <b>154577<br/>CUILLÈRE À MOKA</b><br>DEMI TASSE SPOON<br>CUCHARA DE MOKA<br>11,1 CM - 4 IN <sup>3/8</sup>                        |
|     | <b>199761<br/>COUTEAU À STEAK<br/>MONOBLOC LAME SCIE</b><br>STEAK KNIFE SOLID HANDLE SERRATED<br>CUCHILLO DE STEAK HOJA SIERRA<br>22,8 CM - 9 IN                        |    | <b>190016<br/>CUILLÈRE À SODA</b><br>ICED TEA SPOON<br>CUCHARA DE SODA/HELADO<br>19 CM - 7 IN <sup>1/2</sup>                     |
|    | <b>153996<br/>CUILLÈRE DE TABLE</b><br>TABLE/PASTA SPOON<br>CUCHARA DE MESA<br>20,7 CM - 8 IN <sup>5/8</sup>  |    | <b>154547<br/>FOURCHETTE À GÂTEAUX/<br/>COCKTAIL</b><br>PASTRY/COCKTAIL FORK<br>TENEDOR DE PASTEL<br>14 CM - 5 IN <sup>1/2</sup> |
|    | <b>190015<br/>CUILLÈRE À SOUPE ANGLAISE</b><br>BOUILLON SPOON, ROUND<br>CUCHARA DE CONSOMÉ<br>18,3 CM - 7 IN <sup>3/8</sup>   |    | <b>154563<br/>FOURCHETTE DE SERVICE</b><br>SERVING FORK<br>TENEDOR DE SERVICIO/ENSALADA<br>25,1 CM - 9 IN <sup>7/8</sup>         |
|   | <b>154571<br/>CUILLÈRE À DESSERT</b><br>DESSERT /SOUP SPOON, OVAL<br>CUCHARA DE POSTRE<br>18,6 CM - 7 IN <sup>5/16</sup>  |   | <b>154562<br/>CUILLÈRE DE SERVICE</b><br>SERVING SPOON<br>CUCHARA DE SERVICIO/ENSALADA<br>25,5 CM - 10 IN <sup>1/16</sup>        |
|  | <b>154574<br/>FOURCHETTE À DESSERT</b><br>DESSERT /SALAD FORK<br>TENEDOR DE POSTRE<br>18,6 CM - 7 IN <sup>5/16</sup>  |  | <b>154566<br/>SERVICE À SALADE</b><br>SALAD SERVING SET<br>SET SERVICIO DE ENSALADA<br>24,3 CM - 9 IN <sup>5/16</sup>            |
|   | <b>154555<br/>COUTEAU À DESSERT<br/>MONOBLOC LAME SCIE</b><br>DESSERT KNIFE SOLID HANDLE<br>SERRATED<br>CUCHILLO DE POSTRE HOJASIERRA<br>21,1 CM - 8 IN <sup>5/16</sup> |  | <b>154552<br/>PELLE À TARTE MONOBLOC</b><br>PASTRY SERVER SOLID HANDLE<br>PALA PARA TARTA<br>25,3 CM - 9 IN <sup>5/16</sup>      |
|  | <b>154580<br/>COUTEAU À BEURRE<br/>MONOBLOC LAME UNIE</b><br>BUTTER KNIFE SOLID HANDLE<br>CUCHILLO DE MANTEQUILLA<br>HOJA LISA<br>19,4 CM - 7 IN <sup>5/8</sup>         |  | <b>154550<br/>LOUCHE</b><br>SOUP LADLE<br>CAZO<br>29,7 CM - 11 IN <sup>11/16</sup>   |
|  | <b>154558<br/>FOURCHETTE À POISSON</b><br>FISH FORK<br>TENEDOR DE PESCADO<br>18,7 CM - 7 IN <sup>3/8</sup>  |  |  |
|  | <b>154561<br/>COUTEAU À POISSON</b><br>FISH KNIFE<br>CUCHILLO DE PESCADO<br>21,1 CM - 8 IN <sup>5/16</sup>  |  |  |



©Patrick ROUGEREAU



	226167 <b>FOURCHETTE DE TABLE</b> TABLE FORK TENEDOR DE MESA 21 CM - 8 IN <sup>1/4</sup>		226169 <b>CUILLÈRE À CAFÉ</b> COFFEE/TEA SPOON CUCHARA DE CAFÉ 14,5 CM - 5 IN <sup>1/16</sup>
	226177 <b>COUTEAU DE TABLE MONOBLOC LAME SCIE N°1</b> TABLE KNIFE SOLID HANDLE SERRATED N°1 CUCHILLO DE MESA HOJA SIERRA N°1 22,8 CM - 9 IN		226170 <b>CUILLÈRE À MOKA</b> DEMI TASSE SPOON CUCHARA DE MOKA 11,6 CM - 4 IN <sup>9/16</sup>
	226176 <b>COUTEAU À STEAK MONOBLOC LAME SCIE N°2</b> STEAK KNIFE SOLID HANDLE SERRATED N°2 CUCHILLO DE STEAK HOJA SIERRA N°2 22,8 CM - 9 IN		226175 <b>CUILLÈRE À SODA</b> ICED TEA SPOON CUCHARA DE SODA/HELADO 19 CM - 7 IN <sup>1/2</sup>
	226168 <b>CUILLÈRE DE TABLE</b> TABLE/PASTA SPOON CUCHARA DE MESA 21 CM - 8 IN <sup>1/4</sup>		226174 <b>FOURCHETTE À GÂTEAUX/ COCKTAIL</b> PASTRY/COCKTAIL FORK TENEDOR DE PASTEL 14,5 CM - 5 IN <sup>1/16</sup>
	226172 <b>CUILLÈRE À DESSERT</b> DESSERT /SOUP SPOON, OVAL CUCHARA DE POSTRE 18,9 CM - 7 IN <sup>7/16</sup>		190424 <b>FOURCHETTE À HUÎTRES</b> OYSTER FORK TENEDOR DE OSTRAS 14,1 CM - 5 IN <sup>9/16</sup>
	226171 <b>FOURCHETTE À DESSERT</b> DESSERT /SALAD FORK TENEDOR DE POSTRE 18,9 CM - 7 IN <sup>7/16</sup>		197522 <b>FOURCHETTE DE SERVICE</b> SERVING FORK TENEDOR DE SERVICIO/ENSALADA 26,6 CM - 10 IN <sup>1/2</sup>
	226179 <b>COUTEAU À DESSERT MONOBLOC LAME UNIE N°1</b> DESSERT KNIFE SOLID HANDLE N°1 CUCHILLO DE POSTRE HOJA LISA N°1 20,5 CM - 8 IN <sup>1/16</sup>		197523 <b>CUILLÈRE DE SERVICE</b> SERVING SPOON CUCHARA DE SERVICIO/ENSALADA 27 CM - 10 IN <sup>5/8</sup>
	226178 <b>COUTEAU À DESSERT MONOBLOC LAME UNIE N°2</b> DESSERT KNIFE SOLID HANDLE N°2 CUCHILLO DE POSTRE HOJA LISA N°2 20,5 CM - 8 IN <sup>1/16</sup>		197525 <b>SERVICE À SALADE</b> SALAD SERVING SET SET SERVICIO DE ENSALADA 30 CM - 11 IN <sup>13/16</sup>
	226171 <b>FOURCHETTE À POISSON</b> FISH FORK TENEDOR DE PESCADO 18,9 CM - 7 IN <sup>7/16</sup>		197527 <b>PELLE À TARTE MONOBLOC</b> PASTRY SERVER SOLID HANDLE PALA PARA TARTA 25,1 CM - 9 IN <sup>7/8</sup>
	226173 <b>COUTEAU À POISSON/ GOURMET</b> GOURMET FISH KNIFE CUCHILLO DE PESCADO 21 CM - 8 IN <sup>1/4</sup>		153193 <b>LOUCHE</b> SOUP LADLE CAZO 29,7 CM - 11 IN <sup>11/16</sup>
			154606 <b>LOUCHE À SAUCE</b> SAUCE LADLE CAZO PARA SALSA 18,5 CM - 7 IN <sup>5/16</sup>



Possibilité de personnalisation  
Bespoke options available - Posibilidad de personalización

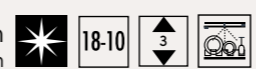



163580  
**FOURCHETTE DE TABLE**  
TABLE FORK  
TENEDOR DE MESA  
20,9 CM - 8 IN<sup>3/16</sup>



189969  
**COUTEAU DE TABLE MONOBLOC LAME SCIE**  
TABLE KNIFE SOLID HANDLE SERRATED  
CUCHILLO DE MESA HOJA SIERRA  
22,9 CM - 9 IN



207189  
**COUTEAU À STEAK MONOBLOC LAME SCIE**  
STEAK KNIFE SOLID HANDLE SERRATED  
CUCHILLO DE STEAK HOJA SIERRA  
23,6 CM - 9 IN<sup>5/16</sup>



163579  
**CUILLÈRE DE TABLE**  
TABLE/PASTA SPOON  
CUCHARA DE MESA  
21,1 CM - 8 IN<sup>5/16</sup>



164713  
**CUILLÈRE À DESSERT**  
DESSERT / SOUP SPOON, OVAL  
CUCHARA DE POSTRE  
19 CM - 7 IN<sup>1/2</sup>



164714  
**FOURCHETTE À DESSERT**  
DESSERT / SALAD FORK  
TENEDOR DE POSTRE  
18,9 CM - 7 IN<sup>7/16</sup>



210627  
**COUTEAU À DESSERT MONOBLOC LAME SCIE**  
DESSERT KNIFE SOLID HANDLE SERRATED  
CUCHILLO DE POSTRE HOJA SIERRA  
20,6 CM - 8 IN<sup>1/8</sup>



189971  
**COUTEAU À BEURRE MONOBLOC LAME UNIE**  
BUTTER KNIFE SOLID HANDLE  
CUCHILLO DE MANTEQUILLA HOJA LISA  
18,8 CM - 7 IN<sup>3/8</sup>



164708  
**FOURCHETTE À POISSON**  
FISH FORK  
TENEDOR DE PESCADO  
18,9 CM - 7 IN<sup>7/16</sup>



164709  
**COUTEAU À POISSON/ GOURMET**  
GOURMET FISH KNIFE  
CUCHILLO DE PESCADO  
21 CM - 8 IN<sup>1/4</sup>



163581  
**CUILLÈRE À CAFÉ**  
COFFEE/TEA SPOON  
CUCHARA DE CAFÉ  
14,3 CM - 5 IN<sup>9/8</sup>



164715  
**CUILLÈRE À MOKA/TOUILLETTE**  
DEMI TASSE SPOON  
CUCHARA DE MOKA  
11 CM - 4 IN<sup>5/16</sup>



189973  
**CUILLÈRE À SODA**  
ICED TEA SPOON  
CUCHARA DE SODA/HELADO  
19 CM - 7 IN<sup>1/2</sup>



164705  
**FOURCHETTE À GÂTEAUX/ COCKTAIL**  
PASTRY/COCKTAIL FORK  
TENEDOR DE PASTEL  
14,4 CM - 5 IN<sup>1/16</sup>



189974  
**FOURCHETTE À HUÎTRES**  
OYSTER FORK  
TENEDOR DE OSTRAS  
14,1 CM - 5 IN<sup>3/16</sup>

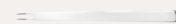

162728  
**FOURCHETTE/PIQUE À ESCARGOTS/COCKTAIL**  
COCKTAIL/SNAIL FORK  
TENEDOR DE CARACOL/COCKTAIL  
10,8 CM - 4 IN<sup>1/4</sup>



162730  
**CURETTE À CRUSTACÉS**  
SEAFOOD SCRAPER  
RASQUETA PARA CANGREJO  
19,1 CM - 7 IN<sup>1/2</sup>



231218  
**FOURCHETTE DE SERVICE**  
SERVING FORK  
TENEDOR DE SERVICIO/ENSALADA  
26,6 CM - 10 IN<sup>1/2</sup>



231219  
**CUILLÈRE DE SERVICE**  
SERVING SPOON  
CUCHARA DE SERVICIO/ENSALADA  
26,6 CM - 10 IN<sup>1/2</sup>



231221  
**PELLE À TARTE MONOBLOC**  
PASTRY SERVER SOLID HANDLE  
PALA PARA TARTA  
25,2 CM - 9 IN<sup>5/16</sup>



231220  
**LOUCHE**  
SOUP LADLE  
CAZO  
29 CM - 11 IN<sup>7/16</sup>

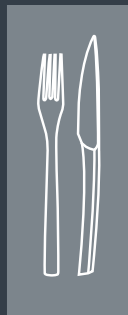

DEGERENNE

Possibilité de personnalisation  
Bespoke options available - Posibilidad de personalización



©Patrick ROUGEREAU



111894  
**FOURCHETTE DE TABLE**  
 TABLE FORK  
 TENEDOR DE MESA  
 20,4 CM - 8 IN<sup>1/16</sup>



111921  
**COUTEAU DE TABLE  
 MONOBLOC LAME SCIE**  
 TABLE KNIFE SOLID HANDLE SERRATED  
 CUCHILLO DE MESA HOJA SIERRA  
 23 CM - 9 IN<sup>1/16</sup>



111891  
**CUILLÈRE DE TABLE**  
 TABLE/PASTA SPOON  
 CUCHARA DE MESA  
 20,4 CM - 8 IN<sup>1/16</sup>



111904  
**CUILLÈRE À DESSERT**  
 DESSERT/SOUP SPOON, OVAL  
 CUCHARA DE POSTRE  
 18 CM - 7 IN<sup>1/16</sup>



111907  
**FOURCHETTE À DESSERT**  
 DESSERT/SALAD FORK  
 TENEDOR DE POSTRE  
 18 CM - 7 IN<sup>1/16</sup>



210631  
**COUTEAU À DESSERT  
 MONOBLOC LAME SCIE**  
 DESSERT KNIFE SOLID HANDLE  
 SERRATED  
 CUCHILLO DE POSTRE HOJA SIERRA  
 20,3 CM - 8 IN



111897  
**CUILLÈRE À CAFÉ**  
 COFFEE/TEA SPOON  
 CUCHARA DE CAFÉ  
 13,6 CM - 5 IN<sup>3/8</sup>



114437  
**CUILLÈRE À MOKA**  
 DEMI TASSE SPOON  
 CUCHARA DE MOKA  
 11 CM - 4 IN<sup>5/16</sup>



© Patrick ROUGEREAU - Photo non contractuelle

**NEW** AZUR - GREEN - VERDE

238531  
**FOURCHETTE DE TABLE**  
TABLE FORK  
TENEDOR DE MESA  
21,6 CM - 8 IN<sup>1/2</sup>



238536  
**COUTEAU DE TABLE**  
**STEAK LAME SCIE**  
STEAK/TABLE KNIFE SERRATED  
CUCHILLO DE STEAK HOJA SIERRA  
23 CM - 9 IN<sup>1/16</sup>



238533  
**CUILLÈRE DE TABLE**  
TABLE/PASTA SPOON  
CUCHARA DE MESA  
21,8 CM - 8 IN<sup>9/16</sup>



238535  
**CUILLÈRE À CAFÉ**  
COFFEE/TEA SPOON  
CUCHARA DE CAFÉ  
15,2 CM - 6 IN



**CARBONE** - CARBON - CARBONO

205883  
**FOURCHETTE DE TABLE**  
TABLE FORK  
TENEDOR DE MESA  
21,6 CM - 8 IN<sup>1/2</sup>



205885  
**COUTEAU DE TABLE**  
**STEAK LAME SCIE**  
STEAK/TABLE KNIFE SERRATED  
CUCHILLO DE STEAK HOJA SIERRA  
23 CM - 9 IN<sup>1/16</sup>



205884  
**CUILLÈRE DE TABLE**  
TABLE/PASTA SPOON  
CUCHARA DE MESA  
21,8 CM - 8 IN<sup>9/16</sup>



205886  
**CUILLÈRE À CAFÉ**  
COFFEE/TEA SPOON  
CUCHARA DE CAFÉ  
15,2 CM - 6 IN



**BLEU MARIN** - STEEL BLUE - AZUL MARINO

226772  
**FOURCHETTE DE TABLE**  
TABLE FORK  
TENEDOR DE MESA  
21,6 CM - 8 IN<sup>1/2</sup>



226774  
**COUTEAU DE TABLE**  
**STEAK LAME SCIE**  
STEAK/TABLE KNIFE SERRATED  
CUCHILLO DE STEAK HOJA SIERRA  
23 CM - 9 IN<sup>1/16</sup>



226773  
**CUILLÈRE DE TABLE**  
TABLE/PASTA SPOON  
CUCHARA DE MESA  
21,8 CM - 8 IN<sup>9/16</sup>



226775  
**CUILLÈRE À CAFÉ**  
COFFEE/TEA SPOON  
CUCHARA DE CAFÉ  
15,2 CM - 6 IN



**NEW** ORCHIDEE - PURPLE - MORADO

238530  
**FOURCHETTE DE TABLE**  
TABLE FORK  
TENEDOR DE MESA  
21,6 CM - 8 IN<sup>1/2</sup>



238537  
**COUTEAU DE TABLE**  
**STEAK LAME SCIE**  
STEAK/TABLE KNIFE SERRATED  
CUCHILLO DE STEAK HOJA SIERRA  
23 CM - 9 IN<sup>1/16</sup>



238532  
**CUILLÈRE DE TABLE**  
TABLE/PASTA SPOON  
CUCHARA DE MESA  
21,8 CM - 8 IN<sup>9/16</sup>



238534  
**CUILLÈRE À CAFÉ**  
COFFEE/TEA SPOON  
CUCHARA DE CAFÉ  
15,2 CM - 6 IN



**ROUGE** - RED - ROJO

206782  
**FOURCHETTE DE TABLE**  
TABLE FORK  
TENEDOR DE MESA  
21,6 CM - 8 IN<sup>1/2</sup>



205894  
**COUTEAU DE TABLE**  
**STEAK LAME SCIE**  
STEAK/TABLE KNIFE SERRATED  
CUCHILLO DE STEAK HOJA SIERRA  
23 CM - 9 IN<sup>1/16</sup>



206783  
**CUILLÈRE DE TABLE**  
TABLE/PASTA SPOON  
CUCHARA DE MESA  
21,8 CM - 8 IN<sup>9/16</sup>



206784  
**CUILLÈRE À CAFÉ**  
COFFEE/TEA SPOON  
CUCHARA DE CAFÉ  
15,2 CM - 6 IN



**CÈPE** - TAUPE - TOPO

226787  
**FOURCHETTE DE TABLE**  
TABLE FORK  
TENEDOR DE MESA  
21,6 CM - 8 IN<sup>1/2</sup>



226789  
**COUTEAU DE TABLE**  
**STEAK LAME SCIE**  
STEAK/TABLE KNIFE SERRATED  
CUCHILLO DE STEAK HOJA SIERRA  
23 CM - 9 IN<sup>1/16</sup>



226788  
**CUILLÈRE DE TABLE**  
TABLE/PASTA SPOON  
CUCHARA DE MESA  
21,8 CM - 8 IN<sup>9/16</sup>



226790  
**CUILLÈRE À CAFÉ**  
COFFEE/TEA SPOON  
CUCHARA DE CAFÉ  
15,2 CM - 6 IN

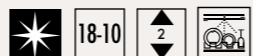

Visuel non contractuel





# COLLECTIONS CLASSIQUES

## NORMANDY

232963 - FOURCHETTE DE TABLE - TABLE FORK - TENEDOR DE MESA

232966 - COUTEAU DE TABLE MONOBLOC LAME SCIE - TABLE KNIFE SOLID HANDLE

SERRATED - CUCHILLO DE MESA HOJA SIERRA

232964 - CUIILLÈRE DE TABLE - TABLE SPOON - CUCHARA DE MESA

232965 - CUIILLÈRE À CAFÉ - COFFEE/TEA SPOON - CUCHARA DE CAFÉ

P. 142-143







126556  
**FOURCHETTE DE TABLE**  
TABLE FORK  
TENEDOR DE MESA  
20,2 CM - 7 IN<sup>15/16</sup>



126565  
**COUTEAU DE TABLE**  
**MANCHE ORFÈVRE LAME UNIE**  
TABLE KNIFE HOLLOW HANDLE  
CUCHILLO DE MESA ENMANGADO  
HOJA LISA  
23 CM - 9 IN<sup>1/16</sup>



130332  
**COUTEAU DE TABLE**  
**MANCHE ORFÈVRE LAME SCIE**  
TABLE KNIFE HOLLOW HANDLE SERRATED  
CUCHILLO DE MESA ENMANGADO  
HOJA SIERRA  
23 CM - 9 IN<sup>1/16</sup>



126553  
**CUILLÈRE DE TABLE**  
TABLE/PASTA SPOON  
CUCHARA DE MESA  
20,5 CM - 8 IN<sup>1/16</sup>



126569  
**CUILLÈRE À DESSERT**  
DESSERT/SOUP SPOON, OVAL  
CUCHARA DE POSTRE  
18 CM - 7 IN<sup>1/16</sup>



126572  
**FOURCHETTE À DESSERT**  
DESSERT/SALAD FORK  
TENEDOR DE POSTRE  
18 CM - 7 IN<sup>1/16</sup>



126575  
**COUTEAU À DESSERT**  
**MANCHE ORFÈVRE LAME UNIE**  
DESSERT KNIFE HOLLOW HANDLE  
CUCHILLO DE POSTRE ENMANGADO HOJA LISA  
20,5 CM - 8 IN<sup>1/16</sup>



154828  
**COUTEAU À BEURRE**  
**MANCHE ORFÈVRE LAME UNIE**  
BUTTER KNIFE HOLLOW HANDLE  
CUCHILLO DE MANTEQUILLA  
ENMANGADO HOJA LISA  
18,8 CM - 7 IN<sup>3/8</sup>



126578  
**FOURCHETTE À POISSON**  
FISH FORK  
TENEDOR DE PESCADO  
18 CM - 7 IN<sup>1/16</sup>



126581  
**COUTEAU À POISSON**  
FISH KNIFE  
CUCHILLO DE PESCADO  
20,1 CM - 7 IN<sup>15/16</sup>



126559  
**CUILLÈRE À CAFÉ**  
COFFEE/TEA SPOON  
CUCHARA DE CAFÉ  
13,9 CM - 5 IN<sup>1/2</sup>



155452  
**CUILLÈRE À MOKA**  
DEMI TASSE SPOON  
CUCHARA DE MOKA  
11,1 CM - 4 IN<sup>3/8</sup>



126591  
**FOURCHETTE DE SERVICE**  
SERVING FORK  
TENEDOR DE SERVICIO/ENSALADA  
24,8 CM - 9 IN<sup>3/4</sup>



126589  
**CUILLÈRE DE SERVICE**  
SERVING SPOON  
CUCHARA DE SERVICIO/ENSALADA  
25 CM - 9 IN<sup>15/16</sup>



126587  
**PELLE À TARTE**  
**MANCHE ORFÈVRE**  
PASTRY SERVER HOLLOW HANDLE  
PALA PARA TARTA ENMANGADO  
24 CM - 9 IN<sup>7/16</sup>



126595  
**LOUCHE À SAUCE**  
SAUCE LADLE  
CAZO PARA SALSA  
17 CM - 6 IN<sup>1/16</sup>



Possibilité de personnalisation  
Bespoke options available - Posibilidad de personalización



© Patrick ROUGÈREAU



232963  
**FOURCHETTE DE TABLE**  
TABLE FORK  
TENEDOR DE MESA  
20,3 CM - 8 IN



232966  
**COUTEAU DE TABLE MONOBLOC LAME SCIE**  
TABLE KNIFE SOLID HANDLE SERRATED  
CUCHILLO DE MESA HOJA SIERRA  
24 CM - 9 IN<sup>7/16</sup>

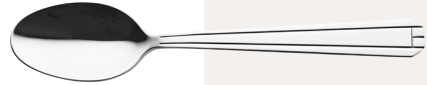

232964  
**CUILLÈRE DE TABLE**  
TABLE/PASTA SPOON  
CUCHARA DE MESA  
20,3 CM - 8 IN



234654  
**CUILLÈRE À SOUPE ANGLAISE**  
BOUILLON SPOON  
CUCHARA DE CONSOMÉ  
17,6 CM - 6 IN<sup>5/16</sup>



234659  
**CUILLÈRE À DESSERT**  
DESSERT /SOUP SPOON, OVAL  
CUCHARA DE POSTRE  
18,2 CM - 7 IN<sup>3/16</sup>



234655  
**CUILLÈRE GOURMET**  
GOURMET SPOON  
CUCHARA GOURMET  
18,2 CM - 7 IN<sup>3/16</sup>



234656  
**FOURCHETTE À DESSERT**  
DESSERT/SALAD FORK  
TENEDOR DE POSTRE  
18,3 CM - 7 IN<sup>3/16</sup>



234657  
**COUTEAU À DESSERT MONOBLOC LAME UNIE**  
DESSERT KNIFE SOLID HANDLE  
CUCHILLO DE POSTRE  
21,5 CM - 8 IN<sup>7/16</sup>



234658  
**COUTEAU À BEURRE MONOBLOC LAME UNIE**  
BUTTER KNIFE SOLID HANDLE  
CUCHILLO DE MANTEQUILLA  
HOJA LISA  
18,5 CM - 7 IN<sup>5/16</sup>



232965  
**CUILLÈRE À CAFÉ**  
COFFEE/TEA SPOON  
CUCHARA DE CAFÉ  
14 CM - 5 IN<sup>1/2</sup>



234660  
**CUILLÈRE À MOKA**  
DEMI TASSE SPOON  
CUCHARA DE MOKA  
11,1 CM - 4 IN<sup>3/8</sup>



234661  
**FOURCHETTE À GÂTEAUX/COCKTAIL**  
PASTRY/COCKTAIL FORK  
TENEDOR DE PASTEL  
14 CM - 5 IN<sup>1/2</sup>

Possibilité de personnalisation  
Bespoke options available - Posibilidad de personalización



©Patrick ROUGEREAU





205533  
**FOURCHETTE DE TABLE**  
TABLE FORK  
TENEDOR DE MESA  
20,7 CM - 8 IN<sup>3/8</sup>



205538  
**FOURCHETTE À POISSON**  
FISH FORK  
TENEDOR DE PESCADO  
18,2 CM - 7 IN<sup>3/8</sup>



199160  
**COUTEAU DE TABLE**  
**MANCHE ORFÈVRE LAME SCIE**  
TABLE KNIFE HOLLOW HANDLE SERRATED  
CUCHILLO DE MESA ENMANGADO  
HOJA SIERRA  
23,3 CM - 9 IN<sup>3/16</sup>



205537  
**COUTEAU À POISSON**  
FISH KNIFE  
CUCHILLO DE PESCADO  
21,2 CM - 8 IN<sup>3/8</sup>



215601  
**COUTEAU DE TABLE**  
**MANCHE ORFÈVRE**  
**LAME SCIE RONDE**  
TABLE KNIFE HOLLOW HANDLE SERRATED  
ROUNDED BLADE  
CUCHILLO DE MESA ENMANGADO  
REDONDA HOJA SIERRA  
23,3 CM - 9 IN<sup>3/16</sup>



199159  
**CUILLÈRE À CAFÉ**  
COFFEE/TEA SPOON  
CUCHARA DE CAFÉ  
14,1 CM - 5 IN<sup>9/16</sup>



199161  
**CUILLÈRE À MOKA**  
DEMI TASSE SPOON  
CUCHARA DE MOKA  
11,2 CM - 4 IN<sup>7/16</sup>



205534  
**CUILLÈRE DE TABLE**  
TABLE/PASTA SPOON  
CUCHARA DE MESA  
20,7 CM - 8 IN<sup>1/8</sup>



199169  
**CUILLÈRE À SODA**  
ICED TEA SPOON  
CUCHARA DE SODA/HELADO  
18,8 CM - 7 IN<sup>3/8</sup>



205535  
**CUILLÈRE À SOUPE ANGLAISE**  
BOUILLON SPOON, ROUND  
CUCHARA DE CONSOMÉ  
17,7 CM - 6 IN<sup>15/16</sup>



199167  
**FOURCHETTE À GÂTEAUX/COCKTAIL**  
PASTRY/COCKTAIL FORK  
TENEDOR DE PASTEL  
14,2 CM - 5 IN<sup>3/16</sup>



205539  
**CUILLÈRE À DESSERT**  
DESSERT/SOUP SPOON, OVAL  
CUCHARA DE POSTRE  
18,2 CM - 7 IN<sup>3/16</sup>



199172  
**FOURCHETTE DE SERVICE**  
SERVING FORK  
TENEDOR DE SERVICIO/ENSALADA  
25 CM - 9 IN<sup>13/16</sup>



205538  
**FOURCHETTE À DESSERT**  
DESSERT/SALAD FORK  
TENEDOR DE POSTRE  
18,2 CM - 7 IN<sup>3/16</sup>

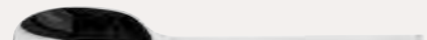

199171  
**CUILLÈRE DE SERVICE**  
SERVING SPOON  
CUCHARA DE SERVICIO/ENSALADA  
25 CM - 9 IN<sup>13/16</sup>



199164  
**COUTEAU À DESSERT**  
**MANCHE ORFÈVRE LAME UNIE**  
DESSERT KNIFE HOLLOW HANDLE  
CUCHILLO DE POSTRE ENMANGADO  
HOJA LISA  
20,6 CM - 8 IN<sup>1/8</sup>



199173  
**PELLE À TARTE**  
**MONOBLOC**  
PASTRY SERVER SOLID HANDLE  
PALA PARA TARTA  
23,9 CM - 9 IN<sup>7/16</sup>



215602  
**COUTEAU À DESSERT**  
**MANCHE ORFÈVRE**  
**LAME UNIE RONDE**  
DESSERT KNIFE HOLLOW  
HANDLE ROUNDED BLADE  
CUCHILLO DE POSTRE  
ENMANGADO  
REDONDA HOJA LISA  
20,6 CM - 8 IN<sup>1/8</sup>



199174  
**LOUCHE**  
SOUP LADLE  
CAZO  
30,2 CM - 11 IN<sup>7/8</sup>



199170  
**COUTEAU À BEURRE**  
**MANCHE ORFÈVRE LAME UNIE**  
BUTTER KNIFE HOLLOW HANDLE  
CUCHILLO DE MANTEQUILLA  
ENMANGADO HOJA LISA  
18,5 CM - 7 IN<sup>5/16</sup>



Possibilité de personnalisation  
Bespoke options available - Posibilidad de personalización

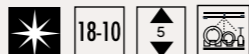

©Patrick ROUGÈREAU



126077  
**FOURCHETTE DE TABLE**  
 TABLE FORK  
 TENEDOR DE MESA  
 20,8 CM - 8 IN<sup>3/16</sup>



190643  
**COUTEAU DE TABLE MONOBLOC LOURD MANCHE DROIT LAME SCIE**  
 TABLE KNIFE HEAVY SOLID HANDLE SERRATED  
 CUCHILLO DE MESA PESADO RECTO MANGO HOJA SIERRA  
 24,6 CM - 9 IN<sup>17/16</sup>



130140  
**COUTEAU DE TABLE MANCHE ORFÈVRE DROIT LAME SCIE**  
 TABLE KNIFE HOLLOW HANDLE SERRATED  
 CUCHILLO DE MESA ENMANGADO RECTO MANGO HOJA SIERRA  
 24,6 CM - 9 IN<sup>17/16</sup>



127654  
**COUTEAU À STEAK MANCHE ORFÈVRE DROIT LAME SCIE**  
 STEAK KNIFE HOLLOW HANDLE SERRATED  
 CUCHILLO DE STEAK ENMANGADO HOJA SIERRA  
 23,9 CM - 9 IN<sup>7/16</sup>



126074  
**CUILLÈRE DE TABLE**  
 TABLE/PASTA SPOON  
 CUCHARA DE MESA  
 20,8 CM - 8 IN<sup>3/16</sup>



127651  
**CUILLÈRE À SOUPE ANGLAISE**  
 BOUILLON SPOON, ROUND  
 CUCHARA DE CONSOMÉ  
 17,4 CM - 6 IN<sup>7/16</sup>



126090  
**CUILLÈRE À DESSERT**  
 DESSERT/SOUP SPOON, OVAL  
 CUCHARA DE POSTRE  
 18 CM - 7 IN<sup>1/16</sup>



126093  
**FOURCHETTE À DESSERT**  
 DESSERT/SALAD FORK  
 TENEDOR DE POSTRE  
 17,8 CM - 7 IN



190644  
**COUTEAU À DESSERT MONOBLOC LOURD MANCHE DROIT LAME SCIE**  
 DESSERT KNIFE HEAVY SOLID HANDLE SERRATED  
 CUCHILLO DE POSTRE PESADO RECTO MANGO HOJA SIERRA  
 20,5 CM - 8 IN<sup>1/16</sup>



126096  
**COUTEAU À DESSERT MANCHE ORFÈVRE LAME UNIE**  
 DESSERT KNIFE HOLLOW HANDLE  
 CUCHILLO DE POSTRE RECTO MANGO ENMANGADO HOJA LISA  
 20,5 CM - 8 IN<sup>1/16</sup>



190417  
**COUTEAU À BEURRE MONOBLOC LOURD MANCHE DROIT LAME UNIE**  
 BUTTER KNIFE HEAVY SOLID HANDLE  
 CUCHILLO DE MANTEQUILLA PESADO RECTO MANGO HOJA LISA  
 18,7 CM - 7 IN<sup>3/8</sup>



129344  
**COUTEAU À BEURRE MANCHE DROIT LAME UNIE**  
 BUTTER KNIFE SOLID HANDLE  
 CUCHILLO DE MANTEQUILLA ENMANGADO HOJA LISA  
 18,7 CM - 7 IN<sup>3/8</sup>



126099  
**FOURCHETTE À POISSON**  
 FISH FORK  
 TENEDOR DE PESCADO  
 17,7 CM - 6 IN<sup>15/16</sup>



126102  
**COUTEAU À POISSON**  
 FISH KNIFE  
 CUCHILLO DE PESCADO  
 19,9 CM - 7 IN<sup>13/16</sup>



129958  
**CUILLÈRE À SAUCE GOURMET**  
 GOURMET/SAUCE SPOON  
 CUCHARA PARA SALSA  
 17,9 CM - 7 IN<sup>1/16</sup>



126080  
**CUILLÈRE À CAFÉ**  
 COFFEE/TEA SPOON  
 CUCHARA DE CAFÉ  
 14 CM - 5 IN<sup>1/2</sup>



126105  
**CUILLÈRE À MOKA**  
 DEMI TASSE SPOON  
 CUCHARA DE MOKA  
 11 CM - 4 IN<sup>5/16</sup>



130146  
**CUILLÈRE À SODA**  
 ICED TEA SPOON  
 CUCHARA DE SODA/HELADO  
 18,2 CM - 7 IN<sup>3/16</sup>



126108  
**FOURCHETTE À GÂTEAUX/COCKTAIL**  
 PASTRY/COCKTAIL FORK  
 TENEDOR DE PASTEL  
 13,8 CM - 5 IN<sup>7/16</sup>



190418  
**FOURCHETTE À HÙITRES**  
 OYSTER FORK  
 TENEDOR DE OSTRAS  
 13 CM - 5 IN<sup>1/8</sup>

**PIÈCES DE SERVICE**

SERVING PIECES  
 SET SERVICIO

**VERLAINE**  
 P 156-157

Possibilité de personnalisation  
 Bespoke options available - Posibilidad de personalización

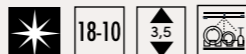

© Patrick ROUGÉREAU





182968  
**FOURCHETTE DE TABLE**  
TABLE FORK  
TENEDOR DE MESA  
20,8 CM - 8 IN<sup>3/16</sup>



182972  
**FOURCHETTE À POISSON**  
FISH FORK  
TENEDOR DE PESCADO  
17,7 CM - 6 IN<sup>15/16</sup>



182970  
**COUTEAU DE TABLE**  
**MANCHE ORFÈVRE LAME SCIE**  
TABLE KNIFE HOLLOW HANDLE SERRATED  
CUCHILLO DE MESA ENMANGADO  
HOJA SIERRA  
24,6 CM - 9 IN<sup>11/16</sup>



182973  
**COUTEAU À POISSON**  
FISH KNIFE  
CUCHILLO DE PESCADO  
19,9 CM - 7 IN<sup>13/16</sup>



186278  
**COUTEAU À STEAK**  
**MANCHE ORFÈVRE LAME SCIE**  
STEAK KNIFE HOLLOW HANDLE SERRATED  
CUCHILLO DE STEAK ENMANGADO  
HOJA SIERRA  
23,9 CM - 9 IN<sup>7/16</sup>



186277  
**CUILLÈRE À SAUCE GOURMET**  
GOURMET/SAUCE SPOON  
CUCHARA PARA SALSA  
17,9 CM - 7 IN<sup>1/16</sup>



182967  
**CUILLÈRE DE TABLE**  
TABLE/PASTA SPOON  
CUCHARA DE MESA  
20,8 CM - 8 IN<sup>3/16</sup>



182969  
**CUILLÈRE À CAFÉ**  
COFFEE/TEA SPOON  
CUCHARA DE CAFÉ  
14 CM - 5 IN<sup>1/2</sup>



186276  
**CUILLÈRE À SOUPE ANGLAISE**  
BOUILLON SPOON, ROUND  
CUCHARA DE CONSOMÉ  
17,4 CM - 6 IN<sup>7/8</sup>



182976  
**CUILLÈRE À MOKA**  
DEMI TASSE SPOON  
CUCHARA DE MOKA  
11 CM - 4 IN<sup>5/16</sup>



182974  
**CUILLÈRE À DESSERT**  
DESSERT/SOUP SPOON, OVAL  
CUCHARA DE POSTRE  
18 CM - 7 IN<sup>7/16</sup>



186275  
**CUILLÈRE À SODA**  
ICED TEA SPOON  
CUCHARA DE SODA/HELADO  
18,2 CM - 7 IN<sup>3/16</sup>



182975  
**FOURCHETTE À DESSERT**  
DESSERT/SALAD FORK  
TENEDOR DE POSTRE  
17,8 CM - 7 IN



186274  
**FOURCHETTE À GÂTEAUX/COCKTAIL**  
PASTRY/COCKTAIL FORK  
TENEDOR DE PASTEL  
13,8 CM - 5 IN<sup>7/16</sup>



182971  
**COUTEAU À DESSERT**  
**MANCHE ORFÈVRE LAME UNIE**  
DESSERT KNIFE HOLLOW HANDLE  
CUCHILLO DE POSTRE ENMANGADO  
HOJA LISA  
20,5 CM - 8 IN<sup>1/16</sup>



190681  
**FOURCHETTE À HÙITRES**  
OYSTER FORK  
TENEDOR DE OSTRAS  
13 CM - 5 IN<sup>1/8</sup>



186279  
**COUTEAU À BEURRE**  
**MANCHE ORFÈVRE LAME UNIE**  
BUTTER KNIFE HOLLOW HANDLE  
CUCHILLO DE MANTEQUILLA  
ENMANGADO HOJA LISA  
18,7 CM - 7 IN<sup>3/8</sup>



183803  
**FOURCHETTE DE SERVICE**  
SERVING FORK  
TENEDOR DE SERVICIO/ENSALADA  
24,8 CM - 9 IN<sup>3/4</sup>



183802  
**CUILLÈRE DE SERVICE**  
SERVING SPOON  
CUCHARA DE SERVICIO/ENSALADA  
25 CM - 9 IN<sup>13/16</sup>



Possibilité de personnalisation  
Bespoke options available - Posibilidad de personalización



© Patrick ROUGÉREAU



127442  
**FOURCHETTE DE TABLE**  
TABLE FORK  
TENEDOR DE MESA  
20,8 CM - 8 IN<sup>3/16</sup>



226578  
**COUTEAU DE TABLE MONOBLOC LOURD LAME SCIE**  
TABLE KNIFE HEAVY SOLID HANDLE SERRATED  
CUCHILLO DE MESA PESADO  
HOJA SIERRA  
24,6 CM - 9 IN<sup>11/16</sup>



139158  
**COUTEAU DE TABLE MANCHE ORFÈVRE LAME SCIE**  
TABLE KNIFE HOLLOW HANDLE SERRATED  
CUCHILLO DE MESA ENMANGADO  
HOJA SIERRA  
24,6 CM - 9 IN<sup>11/16</sup>



128841  
**COUTEAU À STEAK MANCHE ORFÈVRE LAME SCIE**  
STEAK KNIFE HOLLOW HANDLE SERRATED  
CUCHILLO DE STEAK ENMANGADO  
HOJA SIERRA  
23,9 CM - 9 IN<sup>7/16</sup>



127439  
**CUILLÈRE DE TABLE**  
TABLE/PASTA SPOON  
CUCHARA DE MESA  
20,8 CM - 8 IN<sup>3/16</sup>



130273  
**CUILLÈRE À SOUPE ANGLAISE**  
BOUILLON SPOON, ROUND  
CUCHARA DE CONSOMÉ  
17,4 CM - 6 IN<sup>7/16</sup>



127464  
**CUILLÈRE À DESSERT**  
DESSERT/SOUP SPOON, OVAL  
CUCHARA DE POSTRE  
18 CM - 7 IN<sup>1/16</sup>



127467  
**FOURCHETTE À DESSERT**  
DESSERT/SALAD FORK  
TENEDOR DE POSTRE  
17,8 CM - 7 IN



226579  
**COUTEAU À DESSERT MONOBLOC LOURD LAME UNIE**  
DESSERT KNIFE HEAVY SOLID HANDLE  
CUCHILLO DE POSTRE PESADO  
HOJA LISA  
21,1 CM - 8 IN<sup>5/16</sup>



127470  
**COUTEAU À DESSERT MANCHE ORFÈVRE LAME UNIE**  
DESSERT KNIFE HOLLOW HANDLE  
CUCHILLO DE POSTRE ENMANGADO  
HOJA LISA  
20,5 CM - 8 IN<sup>1/16</sup>



226580  
**COUTEAU À BEURRE MONOBLOC LOURD LAME UNIE**  
BUTTER KNIFE HEAVY SOLID HANDLE  
CUCHILLO DE MANTEQUILLA  
PESADO HOJA LISA  
19 CM - 7 IN<sup>1/2</sup>



122769  
**COUTEAU À BEURRE MANCHE ORFÈVRE LAME UNIE**  
BUTTER KNIFE HOLLOW HANDLE  
CUCHILLO DE MANTEQUILLA  
ENMANGADO HOJA LISA  
18,7 CM - 7 IN<sup>3/8</sup>



127473  
**FOURCHETTE À POISSON**  
FISH FORK  
TENEDOR DE PESCADO  
17,7 CM - 6 IN<sup>15/16</sup>



127477  
**COUTEAU À POISSON**  
FISH KNIFE  
CUCHILLO DE PESCADO  
19,9 CM - 7 IN<sup>13/16</sup>



130542  
**CUILLÈRE À SAUCE GOURMET**  
GOURMET/SAUCE SPOON  
CUCHARA PARA SALSA  
17,9 CM - 7 IN<sup>1/16</sup>



127455  
**CUILLÈRE À CAFÉ**  
COFFEE/TEA SPOON  
CUCHARA DE CAFÉ  
14 CM - 5 IN<sup>1/2</sup>



127479  
**CUILLÈRE À MOKA**  
DEMI TASSE SPOON  
CUCHARA DE MOKA  
11 CM - 4 IN<sup>5/16</sup>



127482  
**FOURCHETTE À GÂTEAUX/ COCKTAIL**  
PASTRY/COCKTAIL FORK  
TENEDOR DE PASTEL  
13,8 CM - 5 IN<sup>7/16</sup>



130266  
**FOURCHETTE À HÛÎTRES**  
OYSTER FORK  
TENEDOR DE OSTRAS  
13 CM - 5 IN<sup>1/16</sup>

**PIÈCES DE SERVICE**  
SERVING PIECES  
SET SERVICIO

**VERLAINE**  
P 156-157

Possibilité de personnalisation  
Bespoke options available - Posibilidad de personalización

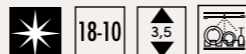

© Patrick ROUGÉREAU





105278  
**FOURCHETTE DE TABLE**  
TABLE FORK  
TENEDOR DE MESA  
20,8 CM - 8 IN<sup>3/16</sup>



105274  
**COUTEAU DE TABLE**  
**MANCHE ORFÈVRE LAME SCIE**  
TABLE KNIFE HOLLOW HANDLE SERRATED  
CUCHILLO DE MESA ENMANGADO  
HOJA SIERRA  
24,6 CM - 9 IN<sup>11/16</sup>



105310  
**CUILLÈRE DE TABLE**  
TABLE/PASTA SPOON  
CUCHARA DE MESA  
20,8 CM - 8 IN<sup>3/16</sup>



105294  
**CUILLÈRE À DESSERT**  
DESSERT/SOUP SPOON, OVAL  
CUCHARA DE POSTRE  
18 CM - 7 IN<sup>1/16</sup>



105290  
**FOURCHETTE À DESSERT**  
DESSERT/SALAD FORK  
TENEDOR DE POSTRE  
17,8 CM - 7 IN



105305  
**COUTEAU À DESSERT**  
**MANCHE ORFÈVRE LAME UNIE**  
DESSERT KNIFE HOLLOW HANDLE  
CUCHILLO DE POSTRE ENMANGADO  
HOJA LISA  
20,5 CM - 8 IN<sup>1/16</sup>



105303  
**CUILLÈRE À CAFÉ**  
COFFEE/TEA SPOON  
CUCHARA DE CAFÉ  
14 CM - 5 IN<sup>1/2</sup>



105293  
**CUILLÈRE À MOKA**  
DEMI TASSE SPOON  
CUCHARA DE MOKA  
11 CM - 4 IN<sup>5/16</sup>



Possibilité de personnalisation  
Bespoke options available - Posibilidad de personalización

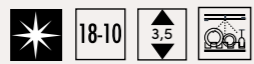

©Patrick ROUGEREAU

Labels d'alcool entendants pour la santé  
Degreene promotes responsible drinking and discourages alcohol misuse  
Etiquetas de alcohol le peligrosas para la salud



105831  
**FOURCHETTE DE TABLE**  
TABLE FORK  
TENEDOR DE MESA  
20,8 CM - 8 IN<sup>3/16</sup>



182460  
**COUTEAU DE TABLE MONOBLOC LOURD LAME SCIE**  
TABLE KNIFE HEAVY SOLID HANDLE  
SERRATED  
CUCHILLO DE MESA PESADO  
HOJA SIERRA  
24,6 CM - 9 IN<sup>11/16</sup>



105886  
**COUTEAU DE TABLE MANCHE ORFÈVRE DROIT LAME UNIE**  
TABLE KNIFE HOLLOW HANDLE  
CUCHILLO DE MESA ENMANGADO  
HOJA LISA  
24,6 CM - 9 IN<sup>11/16</sup>



105860  
**COUTEAU DE TABLE MANCHE ORFÈVRE DROIT LAME SCIE**  
TABLE KNIFE HOLLOW HANDLE SERRATED  
CUCHILLO DE MESA ENMANGADO  
HOJA SIERRA  
24,6 CM - 9 IN<sup>11/16</sup>



105801  
**COUTEAU À STEAK MANCHE ORFÈVRE LAME SCIE**  
STEAK KNIFE HOLLOW HANDLE SERRATED  
CUCHILLO DE STEAK ENMANGADO  
HOJA SIERRA  
23,9 CM - 9 IN<sup>7/16</sup>



105798  
**CUILLÈRE DE TABLE**  
TABLE/PASTA SPOON  
CUCHARA DE MESA  
20,8 CM - 8 IN<sup>3/16</sup>



105908  
**CUILLÈRE À SOUPE ANGLAISE**  
BOUILLON SPOON, ROUND  
CUCHARA DE CONSOMÉ  
17,2 CM - 6 IN<sup>3/4</sup>



105861  
**CUILLÈRE À DESSERT**  
DESSERT/SOUP SPOON, OVAL  
CUCHARA DE POSTRE  
18 CM - 7 IN<sup>1/16</sup>



105885  
**FOURCHETTE À DESSERT**  
DESSERT/SALAD FORK  
TENEDOR DE POSTRE  
17,8 CM - 7 IN



182463  
**COUTEAU À DESSERT MONOBLOC LOURD LAME UNIE**  
DESSERT KNIFE HEAVY SOLID HANDLE  
CUCHILLO DE POSTRE PESADO  
HOJA LISA  
21,1 CM - 8 IN<sup>5/16</sup>



105832  
**COUTEAU À DESSERT MANCHE ORFÈVRE LAME UNIE**  
DESSERT KNIFE HOLLOW HANDLE  
CUCHILLO DE POSTRE RECTO MANGO  
ENMANGADO HOJA LISA  
20,5 CM - 8 IN<sup>1/16</sup>



190420  
**COUTEAU À BEURRE MONOBLOC LOURD LAME UNIE**  
BUTTER KNIFE HEAVY SOLID HANDLE  
CUCHILLO DE MANTEQUILLA  
PESADO HOJA LISA  
19 CM - 7 IN<sup>1/2</sup>



003332  
**COUTEAU À BEURRE MANCHE ORFÈVRE LAME UNIE**  
BUTTER KNIFE HOLLOW HANDLE  
CUCHILLO DE MANTEQUILLA  
ENMANGADO HOJA LISA  
18,7 CM - 7 IN<sup>3/8</sup>



108918  
**FOURCHETTE À POISSON**  
FISH FORK  
TENEDOR DE PESCADO  
17,8 CM - 7 IN



108920  
**COUTEAU À POISSON**  
FISH KNIFE  
CUCHILLO DE PESCADO  
19,7 CM - 7 IN<sup>3/4</sup>



105910  
**CUILLÈRE À SAUCE GOURMET**  
GOURMET/SAUCE SPOON  
CUCHARA PARA SALSA  
17,9 CM - 7 IN<sup>1/16</sup>



105833  
**CUILLÈRE À CAFÉ**  
COFFEE/TEA SPOON  
CUCHARA DE CAFÉ  
14 CM - 5 IN<sup>1/2</sup>



105906  
**CUILLÈRE À MOKA**  
DEMI TASSE SPOON  
CUCHARA DE MOKA  
11 CM - 4 IN<sup>5/16</sup>



105800  
**CUILLÈRE À SODA**  
ICED TEA SPOON  
CUCHARA DE SODA/HELADO  
18,2 CM - 7 IN<sup>3/16</sup>



105795  
**FOURCHETTE À GÂTEAUX/ COCKTAIL**  
PASTRY/COCKTAIL FORK  
TENEDOR DE PASTEL  
13,8 CM - 5 IN<sup>7/16</sup>



Possibilité de personnalisation  
Bespoke options available - Posibilidad de personalización

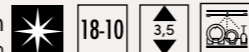

© Patrick ROUGÉREAU





123440  
**FOURCHETTE À HÙITRES**  
OYSTER FORK  
TENEDOR DE OSTRAS  
12,9 CM - 5 IN<sup>7/16</sup>



132782  
**FOURCHETTE À ESCARGOTS**  
SNAIL FORK  
TENEDOR DE CARACOLES  
13,5 CM - 5 IN<sup>7/16</sup>



130994  
**CUILLÈRE À TOASTS**  
APPETIZER SPOON  
CUCHARA PARA APERITIVO  
11,8 CM - 7 IN<sup>5/16</sup>



003390  
**COUTEAU À FROMAGES**  
MANCHE ORFÈVRE LAME UNIE  
CHEESE KNIFE HOLLOW HANDLE  
CUCHILLO DE QUESO ENMANGADO  
19,3 CM - 7 IN<sup>5/8</sup>



002185  
**FOURCHETTE DE SERVICE**  
SERVING FORK  
TENEDOR DE SERVICIO/ENSALADA  
24,8 CM - 9 IN<sup>3/4</sup>



002186  
**CUILLÈRE DE SERVICE**  
SERVING SPOON  
CUCHARA DE SERVICIO/ENSALADA  
25 CM - 9 IN<sup>13/16</sup>



040646  
**SERVICE À SALADE**  
SALADE SERVING SET  
SET SERVICIO DE ENSALADA  
25,8 CM - 10 IN<sup>3/16</sup>



083340  
**PELLE À TARTE MONOBLOC**  
PASTRY SERVER SOLID HANDLE  
PALA PARA TARTA  
24,9 CM - 9 IN<sup>13/16</sup>



097717  
**LOUCHE**  
SOUP LADLE  
CAZO  
29,8 CM - 11 IN<sup>3/4</sup>



002179  
**LOUCHE À SAUCE**  
SAUCE LADLE  
CAZO PARA SALSA  
15,7 CM - 6 IN<sup>3/16</sup>



002191  
**PINCE À SUCRE**  
SUGAR TONG  
PINZA PARA AZÚCAR  
11,5 CM - 4 IN<sup>1/2</sup>



Possibilité de personnalisation  
Bespoke options available - Posibilidad de personalización

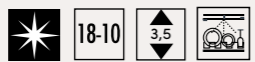



105021  
**FOURCHETTE DE TABLE**  
TABLE FORK  
TENEDOR DE MESA  
20,9 CM - 8 IN<sup>3/16</sup>



190415  
**COUTEAU DE TABLE MONOBLOC LOURD LAME SCIE**  
TABLE KNIFE HEAVY SOLID HANDLE SERRATED  
CUCHILLO DE MESA PESADO  
HOJA SIERRA  
24,8 CM - 9 IN<sup>3/4</sup>



105006  
**COUTEAU DE TABLE MANCHE ORFÈVRE LAME SCIE**  
TABLE KNIFE HOLLOW HANDLE SERRATED  
CUCHILLO DE MESA ENMANGADO  
HOJA SIERRA  
24,7 CM - 9 IN<sup>3/4</sup>



122746  
**COUTEAU À STEAK MANCHE ORFÈVRE LAME SCIE**  
STEAK KNIFE HOLLOW HANDLE SERRATED  
CUCHILLO DE STEAK ENMANGADO  
HOJA SIERRA  
23,8 CM - 9 IN<sup>3/8</sup>



104988  
**CUILLÈRE DE TABLE**  
TABLE/PASTA SPOON  
CUCHARA DE MESA  
21,1 CM - 8 IN<sup>5/16</sup>



104975  
**CUILLÈRE À SOUPE ANGLAISE**  
BOUILLON SPOON, ROUND  
CUCHARA DE CONSOMÉ  
17,4 CM - 6 IN<sup>7/8</sup>



104985  
**CUILLÈRE À DESSERT**  
DESSERT/SOUP SPOON, OVAL  
CUCHARA DE POSTRE  
18 CM - 7 IN<sup>1/8</sup>



105013  
**FOURCHETTE À DESSERT**  
DESSERT/SALAD FORK  
TENEDOR DE POSTRE  
17,9 CM - 7 IN<sup>1/8</sup>



190416  
**COUTEAU À DESSERT MONOBLOC LOURD LAME UNIE**  
DESSERT KNIFE HEAVY SOLID HANDLE  
CUCHILLO DE POSTRE PESADO  
HOJA LISA  
21,3 CM - 8 IN<sup>3/8</sup>



104989  
**COUTEAU À DESSERT MANCHE ORFÈVRE LAME UNIE**  
DESSERT KNIFE HOLLOW HANDLE  
CUCHILLO DE POSTRE ENMANGADO  
HOJA LISA  
20,6 CM - 8 IN<sup>1/8</sup>



190414  
**COUTEAU À BEURRE MONOBLOC LOURD LAME UNIE**  
BUTTER KNIFE HEAVY SOLID HANDLE  
CUCHILLO DE MANTEQUILLA  
PESADO HOJA LISA  
19,7 CM - 7 IN<sup>3/4</sup>



016394  
**COUTEAU À BEURRE MANCHE ORFÈVRE LAME UNIE**  
BUTTER KNIFE HOLLOW HANDLE  
CUCHILLO DE MANTEQUILLA  
ENMANGADO HOJA LISA  
18,9 CM - 7 IN<sup>7/8</sup>



104994  
**FOURCHETTE À POISSON**  
FISH FORK  
TENEDOR DE PESCADO  
17,9 CM - 7 IN<sup>1/8</sup>



104995  
**COUTEAU À POISSON**  
FISH KNIFE  
CUCHILLO DE PESCADO  
20 CM - 7 IN<sup>7/8</sup>



104977  
**CUILLÈRE À SAUCE GOURMET**  
GOURMET/SAUCE SPOON  
CUCHARA PARA SALSA  
18 CM - 7 IN<sup>1/8</sup>



104986  
**CUILLÈRE À CAFÉ**  
COFFEE/TEA SPOON  
CUCHARA DE CAFÉ  
14,1 CM - 5 IN<sup>9/16</sup>



104993  
**CUILLÈRE À MOKA**  
DEMI TASSE SPOON  
CUCHARA DE MOKA  
11,2 CM - 4 IN<sup>7/16</sup>



105012  
**FOURCHETTE À GÂTEAUX/ COCKTAIL**  
PASTRY/COCKTAIL FORK  
TENEDOR DE PASTEL  
13,9 CM - 5 IN<sup>1/2</sup>



Possibilité de personnalisation  
Bespoke options available - Posibilidad de personalización

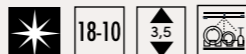

© Patrick ROUGÉREAU



104485  
**FOURCHETTE DE TABLE**  
TABLE FORK  
TENEDOR DE MESA  
20,8 CM - 8 IN<sup>3/16</sup>



182466  
**COUTEAU DE TABLE MONOBLOC LOURD LAME SCIE**  
TABLE KNIFE HEAVY SOLID HANDLE  
SERRATED  
CUCHILLO DE MESA PESADO  
HOJA SIERRA  
24,6 CM - 9 IN<sup>11/16</sup>



161390  
**COUTEAU DE TABLE MANCHE ORFÈVRE DROIT LAME UNIE**  
TABLE KNIFE HOLLOW HANDLE  
CUCHILLO DE MESA ENMANGADO  
HOJA LISA  
24,6 CM - 9 IN<sup>11/16</sup>



161391  
**COUTEAU DE TABLE MANCHE ORFÈVRE LAME SCIE**  
TABLE KNIFE HOLLOW HANDLE SERRATED  
CUCHILLO DE MESA ENMANGADO  
HOJA SIERRA  
24,6 CM - 9 IN<sup>11/16</sup>



122759  
**COUTEAU À STEAK MANCHE ORFÈVRE LAME SCIE**  
STEAK KNIFE HOLLOW HANDLE SERRATED  
CUCHILLO DE STEAK ENMANGADO  
HOJA SIERRA  
23,9 CM - 9 IN<sup>7/16</sup>



104526  
**CUILLÈRE DE TABLE**  
TABLE/PASTA SPOON  
CUCHARA DE MESA  
20,8 CM - 8 IN<sup>3/16</sup>



112695  
**CUILLÈRE À SOUPE ANGLAISE**  
BOUILLON SPOON, ROUND  
CUCHARA DE CONSOMÉ  
17,2 CM - 6 IN<sup>3/4</sup>



104484  
**CUILLÈRE À DESSERT**  
DESSERT/SOUP SPOON, OVAL  
CUCHARA DE POSTRE  
18 CM - 7 IN<sup>1/16</sup>



104543  
**FOURCHETTE À DESSERT**  
DESSERT/SALAD FORK  
TENEDOR DE POSTRE  
17,8 CM - 7 IN



182467  
**COUTEAU À DESSERT MONOBLOC LOURD LAME UNIE**  
DESSERT KNIFE HEAVY SOLID HANDLE  
CUCHILLO DE POSTRE PESADO  
HOJA LISA  
20,5 CM - 8 IN<sup>1/16</sup>



161394  
**COUTEAU À DESSERT MANCHE ORFÈVRE LAME UNIE**  
DESSERT KNIFE HOLLOW HANDLE  
CUCHILLO DE POSTRE RECTO MANGO  
ENMANGADO HOJA LISA  
20,5 CM - 8 IN<sup>1/16</sup>



190419  
**COUTEAU À BEURRE MONOBLOC LOURD LAME UNIE**  
BUTTER KNIFE HEAVY SOLID HANDLE  
CUCHILLO DE MANTEQUILLA  
PESADO HOJA LISA  
18,7 CM - 7 IN<sup>3/8</sup>



122760  
**COUTEAU À BEURRE MANCHE ORFÈVRE LAME UNIE**  
BUTTER KNIFE HOLLOW HANDLE  
CUCHILLO DE MANTEQUILLA  
ENMANGADO HOJA LISA  
18,7 CM - 7 IN<sup>3/8</sup>



108922  
**FOURCHETTE POISSON**  
FISH FORK  
TENEDOR DE PESCADO  
17,8 CM - 7 IN



108924  
**COUTEAU POISSON**  
FISH KNIFE  
CUCHILLO DE PESCADO  
19,7 CM - 7 IN<sup>3/4</sup>



145451  
**CUILLÈRE À SAUCE GOURMET**  
GOURMET/SAUCE SPOON  
CUCHARA PARA SALSA  
17,9 CM - 7 IN<sup>1/16</sup>



104561  
**CUILLÈRE À CAFÉ**  
COFFEE/TEA SPOON  
CUCHARA DE CAFÉ  
14 CM - 5 IN<sup>1/2</sup>



161398  
**CUILLÈRE À MOKA**  
DEMI TASSE SPOON  
CUCHARA DE MOKA  
11 CM - 4 IN<sup>5/16</sup>



124259  
**CUILLÈRE À SODA**  
ICED TEA SPOON  
CUCHARA DE SODA/HELADO  
18,2 CM - 7 IN<sup>3/16</sup>



104480  
**FOURCHETTE À GÂTEAUX/ COCKTAIL**  
PASTRY/COCKTAIL FORK  
TENEDOR DE PASTEL  
13,8 CM - 5 IN<sup>7/16</sup>



123434  
**FOURCHETTE À HUITRES**  
OYSTER FORK  
TENEDOR DE OSTRAS  
12,9 CM - 5 IN<sup>1/16</sup>



DEGENERE

Possibilité de personnalisation  
Bespoke options available - Posibilidad de personalización

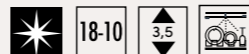

@Patrick ROUGEREAU

Tous droits réservés pour la France  
All rights reserved for France  
El abuso de alcohol es peligroso para la salud



189208  
**COUTEAU À FROMAGE**  
**MANCHE ORFÈVRE LAME UNIE**  
CHEESE KNIFE HOLLOW HANDLE  
CUCHILLO DE QUESO ENMANGADO  
19,3 CM - 7 IN<sup>5/8</sup>



195757  
**FOURCHETTE DE SERVICE**  
SERVING FORK  
TENEDOR DE SERVICIO/ENSALADA  
24,8 CM - 9 IN<sup>3/4</sup>



195755  
**CUILLÈRE DE SERVICE**  
SERVING SPOON  
CUCHARA DE SERVICIO/ENSALADA  
25 CM - 9 IN<sup>13/16</sup>



195757  
**FOURCHETTE À DÉCOUPER**  
CARVING FORK  
TENEDOR TRINCHANTE  
24,8 CM - 9 IN<sup>3/4</sup>



189511  
**COUTEAU À DÉCOUPER**  
**MANCHE ORFÈVRE LAME UNIE**  
CARVING KNIFE HOLLOW HANDLE  
CUCHILLO TRINCHANTE ENMANGADO  
HOJA LISA  
28,7 CM - 11 IN<sup>5/16</sup>



195750  
**SERVICE À SALADE**  
SALADE SERVING SET  
SET SERVICIO DE ENSALADA  
25,7 CM - 10 IN<sup>11/16</sup>



195753  
**PELLE À TARTE MONOBLOC**  
PASTRY SERVER SOLID HANDLE  
PALA PARA TARTA  
24,9 CM - 9 IN<sup>13/16</sup>



195762  
**LOUCHE**  
SOUP LADLE  
CAZO  
29,8 CM - 11 IN<sup>3/4</sup>



195759  
**LOUCHE À SAUCE**  
SAUCE LADLE  
CAZO PARA SALSA  
15,7 CM - 6 IN<sup>3/16</sup>



Possibilité de personnalisation  
Bespoke options available - Posibilidad de personalización



©Patrick ROUGEREAU

# MIKADO MIROIR



141089  
**FOURCHETTE DE TABLE**  
TABLE FORK  
TENEDOR DE MESA  
20,3 CM - 8 IN



103550  
**CUILLÈRE À CAFÉ**  
COFFEE/TEA SPOON  
CUCHARA DE CAFÉ  
13,5 CM - 5 IN<sup>5/16</sup>



113017  
**COUTEAU DE TABLE MONOBLOC LOURD LAME SCIE**  
TABLE KNIFE HEAVY SOLID HANDLE SERRATED  
CUCHILLO DE MESA PESADO HOJA SIERRA  
24,4 CM - 9 IN<sup>5/8</sup>



109465  
**CUILLÈRE À MOKA**  
DEMI TASSE SPOON  
CUCHARA DE MOKA  
11 CM - 4 IN<sup>5/16</sup>



160427  
**COUTEAU À STEAK MONOBLOC LAME SCIE**  
STEAK KNIFE SOLID HANDLE SERRATED  
CUCHILLO DE STEAK HOJA SIERRA  
23,2 CM - 9 IN<sup>1/8</sup>



124259  
**CUILLÈRE À SODA**  
ICED TEA SPOON  
CUCHARA DE SODA/HELADO  
18,2 CM - 7 IN<sup>3/16</sup>



141086  
**CUILLÈRE DE TABLE**  
TABLE/PASTA SPOON  
CUCHARA DE MESA  
20,4 CM - 8 IN<sup>1/16</sup>



109466  
**FOURCHETTE À GÂTEAUX/ COCKTAIL**  
PASTRY/COCKTAIL FORK  
TENEDOR DE PASTEL  
15 CM - 5 IN<sup>7/8</sup>



112695  
**CUILLÈRE À SOUPE ANGLAISE**  
BOUILLON SPOON, ROUND  
CUCHARA DE CONSOMÉ  
17,2 CM - 6 IN<sup>3/4</sup>



123434  
**FOURCHETTE À HÛITRES**  
OYSTER FORK  
TENEDOR DE OSTRAS  
12,9 CM - 5 IN<sup>1/16</sup>



108236  
**CUILLÈRE À DESSERT**  
DESSERT/SOUP SPOON, OVAL  
CUCHARA DE POSTRE  
17,9 CM - 7 IN<sup>1/16</sup>



195757  
**FOURCHETTE DE SERVICE**  
SERVING FORK  
TENEDOR DE SERVICIO/ENSALADA  
24,8 CM - 9 IN<sup>3/4</sup>



108238  
**FOURCHETTE À DESSERT**  
DESSERT/SALAD FORK  
TENEDOR DE POSTRE  
17,8 CM - 7 IN



195755  
**CUILLÈRE DE SERVICE**  
SERVING SPOON  
CUCHARA DE SERVICIO/ENSALADA  
25 CM - 9 IN<sup>13/16</sup>



113019  
**COUTEAU À DESSERT MONOBLOC LOURD LAME UNIE**  
DESSERT KNIFE HEAVY SOLID HANDLE CUCHILLO DE POSTRE PESADO HOJA LISA  
21 CM - 8 IN<sup>1/4</sup>



195750  
**SERVICE À SALADE**  
SALAD SERVING SET  
SET SERVICIO/ENSALADA  
25,7 CM - 10 IN<sup>1/8</sup>



195753  
**PELLE À TARTE MONOBLOC**  
PASTRY SERVER SOLID HANDLE  
PALA PARA TARTA  
24,9 CM - 9 IN<sup>13/16</sup>



189971  
**COUTEAU À BEURRE MONOBLOC LAME UNIE**  
BUTTER KNIFE SOLID HANDLE CUCHILLO DE MANTEQUILLA HOJA LISA  
18,9 CM - 7 IN<sup>7/16</sup>



195762  
**LOUCHE**  
SOUP LADLE  
CAZO  
29,8 CM - 11 IN<sup>3/4</sup>



108922  
**FOURCHETTE À POISSON**  
FISH FORK  
TENEDOR DE PESCADO  
17,8 CM - 7 IN



195759  
**LOUCHE À SAUCE**  
SAUCE LADLE  
CAZO PARA SALSA  
15,7 CM - 6 IN<sup>3/16</sup>



108924  
**COUTEAU À POISSON**  
FISH KNIFE  
CUCHILLO DE PESCADO  
19,7 CM - 7 IN<sup>3/4</sup>

Possibilité de personnalisation  
Bespoke options available - Posibilidad de personalización

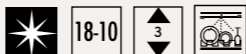

© Patrick ROUGEREAU



# MIKADO VINTAGE



230285  
**FOURCHETTE DE TABLE**  
TABLE FORK  
TENEDOR DE MESA  
20,3 CM - 8 IN



230287  
**COUTEAU DE TABLE  
MONOBLOC LOURD LAME SCIE**  
TABLE KNIFE HEAVY SOLID HANDLE  
SERRATED  
CUCHILLO DE MESA PESADO  
HOJA SIERRA  
24,4 CM - 9 IN<sup>5/8</sup>



230293  
**COUTEAU À STEAK  
MONOBLOC LAME SCIE**  
STEAK KNIFE SOLID HANDLE  
SERRATED  
CUCHILLO DE STEAK  
HOJA SIERRA  
23,2 CM - 9 IN<sup>1/8</sup>



230286  
**CUILLÈRE DE TABLE**  
TABLE/PASTA SPOON  
CUCHARA DE MESA  
20,4 CM - 8 IN<sup>7/16</sup>



230291  
**CUILLÈRE À DESSERT**  
DESSERT/SOUP SPOON, OVAL  
CUCHARA DE POSTRE  
17,9 CM - 7 IN<sup>7/16</sup>



230290  
**FOURCHETTE À DESSERT**  
DESSERT/SALAD FORK  
TENEDOR DE POSTRE  
17,8 CM - 7 IN



230292  
**COUTEAU À DESSERT  
MONOBLOC LOURD LAME UNIE**  
DESSERT KNIFE HEAVY SOLID HANDLE  
CUCHILLO DE POSTRE PESADO  
HOJA LISA  
21 CM - 8 IN<sup>1/4</sup>



232308  
**COUTEAU À BEURRE  
MONOBLOC LAME UNIE**  
BUTTER KNIFE SOLID HANDLE  
CUCHILLO DE MANTEQUILLA  
HOJA LISA  
18,9 CM - 7 IN<sup>7/16</sup>



230288  
**CUILLÈRE À CAFÉ**  
COFFEE/TEA SPOON  
CUCHARA DE CAFÉ  
13,5 CM - 5 IN<sup>5/16</sup>



230289  
**CUILLÈRE À MOKA**  
DEMI TASSE SPOON  
CUCHARA DE MOKA  
11 CM - 4 IN<sup>5/16</sup>

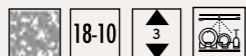

©Patrick ROUGEREAU



141094  
**FOURCHETTE DE TABLE**  
TABLE FORK  
TENEDOR DE MESA  
20,3 CM - 8 IN



103857  
**COUPEAU DE TABLE MONOBLOC LAME SCIE**  
TABLE KNIFE SOLID HANDLE SERRATED  
CUCHILLO DE MESA HOJA SIERRA  
23,7 CM - 9 IN<sup>5/16</sup>



160433  
**COUPEAU À STEAK MONOBLOC LAME SCIE**  
STEAK KNIFE SOLID HANDLE SERRATED  
CUCHILLO DE STEAK HOJA SIERRA  
23,6 CM - 9 IN<sup>5/16</sup>



141092  
**CUILLÈRE DE TABLE**  
TABLE/PASTA SPOON  
CUCHARA DE MESA  
20,4 CM - 8 IN<sup>1/16</sup>



112692  
**CUILLÈRE À SOUPE ANGLAISE**  
BOUILLON SPOON, ROUND  
CUCHARA DE CONSOMÉ  
17,2 CM - 6 IN<sup>3/4</sup>



108232  
**CUILLÈRE À DESSERT**  
DESSERT/SOUP SPOON, OVAL  
CUCHARA DE POSTRE  
17,9 CM - 7 IN<sup>1/16</sup>



108234  
**FOURCHETTE À DESSERT**  
DESSERT/SALAD FORK  
TENEDOR DE POSTRE  
17,8 CM - 7 IN



210628  
**COUPEAU À DESSERT MONOBLOC LAME SCIE**  
DESSERT KNIFE SOLID HANDLE  
CUCHILLO DE POSTRE HOJA SIERRA  
20,6 CM - 8 IN<sup>1/16</sup>



108918  
**FOURCHETTE À POISSON**  
FISH FORK  
TENEDOR DE PESCADO  
17,8 CM - 7 IN



108920  
**COUPEAU À POISSON**  
FISH KNIFE  
CUCHILLO DE PESCADO  
19,7 CM - 7 IN<sup>3/4</sup>



103564  
**CUILLÈRE À CAFÉ**  
COFFEE/TEA SPOON  
CUCHARA DE CAFÉ  
13,5 CM - 5 IN<sup>5/16</sup>



109471  
**CUILLÈRE À MOKA**  
DEMI TASSE SPOON  
CUCHARA DE MOKA  
11 CM - 4 IN<sup>5/16</sup>



105800  
**CUILLÈRE À SODA**  
ICED TEA SPOON  
CUCHARA DE SODA/HELADO  
18,2 CM - 7 IN<sup>3/16</sup>



109472  
**FOURCHETTE À GÂTEAUX/ COCKTAIL**  
PASTRY/COCKTAIL FORK  
TENEDOR DE PASTEL  
15 CM - 5 IN<sup>7/16</sup>



123440  
**FOURCHETTE À HÛÎTRES**  
OYSTER FORK  
TENEDOR DE OSTRAS  
12,9 CM - 5 IN<sup>1/16</sup>



132782  
**FOURCHETTE À ESCARGOTS**  
SNAIL FORK  
TENEDOR DE CARACOLAS  
13,5 CM - 5 IN<sup>5/16</sup>



002185  
**FOURCHETTE DE SERVICE**  
SERVING FORK  
TENEDOR DE SERVICIO/ENSALADA  
24,8 CM - 9 IN<sup>3/4</sup>



002186  
**CUILLÈRE DE SERVICE**  
SERVING SPOON  
CUCHARA DE SERVICIO/ENSALADA  
25 CM - 9 IN<sup>13/16</sup>



040646  
**SERVICE À SALADE**  
SALAD SERVING SET  
SET SERVICIO/ENSALADA  
25,8 CM - 10 IN<sup>13/16</sup>



083340  
**PELLE À TARTE MONOBLOC**  
PASTRY SERVER SOLID HANDLE  
PALA PARA TARTA  
24,9 CM - 9 IN<sup>13/16</sup>



097717  
**LOUCHE**  
SOUP LADLE  
CAZO  
29,8 CM - 11 IN<sup>3/4</sup>



002179  
**LOUCHE À SAUCE**  
SAUCE LADLE  
CAZO PARA SALSA  
15,7 CM - 6 IN<sup>3/16</sup>

Possibilité de personnalisation  
Bespoke options available - Posibilidad de personalización

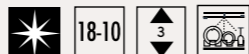

© Patrick ROUGÉREAU



# VIEUX PARIS SATINÉ



105804  
**FOURCHETTE DE TABLE**  
TABLE FORK  
TENEDOR DE MESA  
21 CM - 8 IN<sup>1/4</sup>



105837  
**FOURCHETTE À POISSON**  
FISH FORK  
TENEDOR DE PESCADO  
18 CM - 7 IN<sup>1/16</sup>



105892  
**COUTEAU DE TABLE MONOBLOC LAME SCIE**  
TABLE KNIFE SOLID HANDLE SERRATED  
SERRATED  
CUCHILLO DE MESA  
HOJA SIERRA  
25 CM - 9 IN<sup>3/16</sup>



105912  
**COUTEAU À POISSON**  
FISH KNIFE  
CUCHILLO DE PESCADO  
20 CM - 7 IN<sup>7/8</sup>



105864  
**COUTEAU DE TABLE MANCHE ORFÈVRE LAME UNIE**  
TABLE KNIFE HOLLOW HANDLE  
CUCHILLO DE MESA ENMANGADO  
HOJA LISA  
24,7 CM - 9 IN<sup>3/4</sup>



105838  
**CUILLÈRE À CAFÉ**  
COFFEE/TEA SPOON  
CUCHARA DE CAFÉ  
14,1 CM - 5 IN<sup>9/16</sup>



105913  
**COUTEAU DE TABLE MANCHE ORFÈVRE LAME SCIE**  
TABLE KNIFE HOLLOW HANDLE SERRATED  
CUCHILLO DE MESA ENMANGADO  
HOJA SIERRA  
24,7 CM - 9 IN<sup>3/4</sup>



105891  
**CUILLÈRE À MOKA**  
DEMI TASSE SPOON  
CUCHARA DE MOKA  
11 CM - 4 IN<sup>5/16</sup>



160424  
**COUTEAU À STEAK MONOBLOC LAME SCIE**  
STEAK KNIFE SOLID HANDLE SERRATED  
CUCHILLO DE STEAK HOJA SIERRA  
23,2 CM - 9 IN<sup>1/8</sup>



105805  
**FOURCHETTE À GÂTEAUX/ COCKTAIL**  
PASTRY/COCKTAIL FORK  
TENEDOR DE PASTEL  
13,9 CM - 5 IN<sup>1/2</sup>



105911  
**CUILLÈRE DE TABLE**  
TABLE/PASTA SPOON  
CUCHARA DE MESA  
21 CM - 8 IN<sup>1/4</sup>



105803  
**FOURCHETTE À HÛÎTRES**  
OYSTER FORK  
TENEDOR DE OSTRAS  
13,2 CM - 5 IN<sup>3/16</sup>



105863  
**CUILLÈRE À DESSERT**  
DESSERT/SOUP SPOON, OVAL  
CUCHARA DE POSTRE  
18 CM - 7 IN<sup>1/16</sup>



000490  
**FOURCHETTE DE SERVICE**  
SERVING FORK  
TENEDOR DE SERVICIO/ENSALADA  
24,6 CM - 9 IN<sup>11/16</sup>



105890  
**FOURCHETTE À DESSERT**  
DESSERT/SALAD FORK  
TENEDOR DE POSTRE  
18 CM - 7 IN<sup>1/16</sup>



000491  
**CUILLÈRE DE SERVICE**  
SERVING SPOON  
CUCHARA DE SERVICIO/ENSALADA  
24,9 CM - 9 IN<sup>13/16</sup>



210626  
**COUTEAU À DESSERT MONOBLOC LAME SCIE**  
DESSERT KNIFE SOLID HANDLE SERRATED  
CUCHILLO DE POSTRE HOJA SIERRA  
20,7 CM - 8 IN<sup>1/8</sup>



105802  
**COUTEAU À DESSERT MANCHE ORFÈVRE LAME UNIE**  
DESSERT KNIFE HOLLOW HANDLE SERRATED  
SERRATED  
CUCHILLO DE POSTRE ENMANGADO  
HOJA LISA  
20,5 CM - 8 IN<sup>1/16</sup>



DEGRÈNE

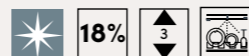

©Patrick ROUGÈREAU



## MIRAGE LES ESSENCES

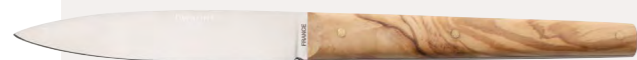

233848  
**COUTEAU À STEAK MANCHE OLIVIER**  
STEAK KNIFE OLIVE WOOD HANDLE  
CUCHILLO STEAK MANGO DE MADERA DE OLIVO  
23 CM - 9 IN<sup>1/16</sup>



233853  
**COUTEAU À STEAK MANCHE PICANA**  
STEAK KNIFE PICANA HANDLE  
CUCHILLO STEAK MANGO DE PICANA  
23 CM - 9 IN<sup>1/16</sup>

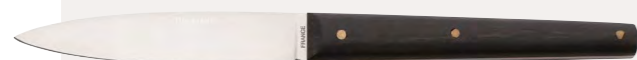

233851  
**COUTEAU À STEAK MANCHE ÉBÈNE**  
STEAK KNIFE EBONY HANDLE  
CUCHILLO STEAK MANGO DE ÉBANO  
23 CM - 9 IN<sup>1/16</sup>

## MIRAGE

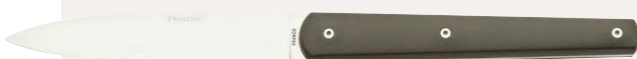

226261  
**COUTEAU DE TABLE/ STEAK LAME UNIE ANTHRACITE**  
BLACK TABLE STEAK KNIFE  
CUCHILLO STEAK NEGRO  
23 CM - 9 IN<sup>1/16</sup>



226263  
**COUTEAU DE TABLE/ STEAK LAME UNIE BLANC**  
WHITE TABLE STEAK KNIFE  
CUCHILLO STEAK BLANCO  
23 CM - 9 IN<sup>1/16</sup>

## LAGUIOLE



232249  
**COUTEAU LAGUIOLE - CORNE NOIRE - MITRE INOX**  
LAGUIOLE STEAK KNIFE BLACK HORN - STEEL BOLSTER  
LAGUIOLE CUCHILLO STEAK CUERNO - MITRA ACERO  
23 CM - 9 IN<sup>1/16</sup>



232251  
**COUTEAU LAGUIOLE - CORNE CLAIRE - MITRE LAITON**  
LAGUIOLE STEAK KNIFE LIGHT HORN - BRASS BOLSTER  
LAGUIOLE CUCHILLO STEAK CUERNO CLARO - MITRA LATON  
23 CM - 9 IN<sup>1/16</sup>



232253  
**COUTEAU LAGUIOLE - IVOIRINE - MITRE INOX**  
LAGUIOLE STEAK KNIFE IVORY COLOR - STEEL BOLSTER  
LAGUIOLE CUCHILLO STEAK COLOR MARFILL - MITRA ACERO  
23 CM - 9 IN<sup>1/16</sup>



232255  
**COUTEAU LAGUIOLE - OLIVIER - MITRE LAITON**  
LAGUIOLE STEAK KNIFE OLIVE WOOD - BRASS BOLSTER  
LAGUIOLE CUCHILLO STEAK OLIVO - MITRA LATON  
23 CM - 9 IN<sup>1/16</sup>

## CAPUCIN



232243  
**COUTEAU À STEAK CAPUCIN NOIR**  
CAPUCIN STEAK KNIFE - BLACK  
CAPUCIN CUCHILLO STEAK - NEGRO  
22,6 CM - 8 IN<sup>7/8</sup>



232245  
**COUTEAU À STEAK CAPUCIN IVOIRINE**  
CAPUCIN STEAK KNIFE - IVORY COLOR  
CAPUCIN CUCHILLO STEAK - COLOR MARFIL  
22,6 CM - 8 IN<sup>7/8</sup>



232247  
**COUTEAU À STEAK CAPUCIN ROUGE**  
CAPUCIN STEAK KNIFE - RED  
CAPUCIN CUCHILLO STEAK - ROJO  
22,6 CM - 8 IN<sup>7/8</sup>

©Patrick ROUGEREAU





190018  
**CUILLÈRE À SODA**  
ICED TEA SPOON  
CUCHARA DE SODA/HELADO  
19 CM - 7 IN<sup>1/2</sup>



189973  
**CUILLÈRE À SODA**  
ICED TEA SPOON  
CUCHARA DE SODA/HELADO  
19 CM - 7 IN<sup>1/2</sup>



226175  
**CUILLÈRE À SODA**  
ICED TEA SPOON  
CUCHARA DE SODA/HELADO  
19 CM - 7 IN<sup>1/2</sup>



162724  
**CUILLÈRE À AGRUMES**  
CITRUS FRUITS SPOON  
CUCHARA PARA POMELO  
15,3 CM - 6 IN



190424  
**FOURCHETTE À HUÎTRES**  
OYSTER FORK  
TENEDOR DE OSTRAS  
14,1 CM - 5 IN<sup>3/16</sup>



189974  
**FOURCHETTE À HUÎTRES**  
OYSTER FORK  
TENEDOR DE OSTRAS  
14,1 CM - 5 IN<sup>3/16</sup>

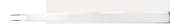

162728  
**FOURCHETTE /PIQUE À ESCARGOTS/COCKTAIL**  
COCKTAIL, SNAIL FORK  
TENEDOR DE CARACOL/COCKTAIL  
10,8 CM - 4 IN<sup>1/4</sup>



162730  
**CURETTE À CRUSTACÉS**  
SEAFOOD SCRAPER  
RASQUETA PARA CANGREJO  
19,1 CM - 7 IN<sup>1/2</sup>



154612  
**COUTEAU À BEURRE MONOBLOC LAME UNIE**  
BUTTER KNIFE SOLID HANDLE  
CUCHILLO DE MANTEQUILLA HOJA LISA  
19,4 CM - 7 IN<sup>5/8</sup>



189971  
**COUTEAU À BEURRE MONOBLOC LAME UNIE**  
BUTTER KNIFE SOLID HANDLE  
CUCHILLO DE MANTEQUILLA HOJA LISA  
18,9 CM - 7 IN<sup>7/16</sup>



159451  
**COUTEAU À STEAK MONOBLOC LAME SCIE**  
STEAK KNIFE SOLID HANDLE SERRATED  
CUCHILLO DE STEAK HOJA SIERRA  
23,5 CM - 9 IN<sup>1/4</sup>



122418  
**COUTEAU À STEAK MONOBLOC LAME SCIE**  
STEAK KNIFE SOLID HANDLE SERRATED  
CUCHILLO DE STEAK HOJA SIERRA  
22,1 CM - 8 IN<sup>11/16</sup>



184492  
**PINCE À CRUSTACÉ**  
SEAFOOD CRACKER  
TENACILLAS PARA CRUSTÁCEOS  
16,5 CM - 6 IN<sup>1/2</sup>



004013  
**PINCE À ESCARGOTS**  
SNAIL TONG  
PINZAS CARACOL/ES  
16 CM - 6 IN<sup>5/16</sup>



204498 101492  
**PINCE À PAIN**  
BREAD TONG  
PINZAS PAN  
23 CM - 9 IN<sup>1/16</sup>



204497 101493  
**PINCE À HOMARD**  
LOBSTER CRACKER  
TENACILLAS PARA BOGAVANTE  
18,5 CM - 7 IN<sup>5/16</sup>



204496 101494  
**CISEAUX À GÂTEAUX**  
PASTRY CISSORS/TONG  
PINZAS PARA PASTELES  
20 CM - 7 IN<sup>7/8</sup>



204499 184355  
**PINCE À SERVIR**  
SERVING TONG  
PINZAS PARA SERVIR  
29,5 CM - 11 IN<sup>5/8</sup>



207257 207538  
**FOURCHETTE À DESSERT**  
DESSERT/SALAD FORK  
TENEDOR DE POSTRE  
16,5 CM - 6 IN<sup>1/2</sup>



207259 207540  
**COUTEAU À DESSERT MONOBLOC LAME UNIE**  
DESSERT KNIFE SOLID HANDLE  
CUCHILLO DE POSTRE HOJA LISA  
17,7 CM - 6 IN<sup>15/16</sup>



207258 207539  
**CUILLÈRE À DESSERT**  
DESSERT/SOUP SPOON, OVAL  
CUCHARA DE POSTRE  
16,5 CM - 6 IN<sup>1/2</sup>



207256 207537  
**CUILLÈRE À CAFÉ**  
COFFEE/TEA SPOON  
CUCHARA DE CAFÉ  
13,2 CM - 5 IN<sup>3/16</sup>



DES LIGNES DOUCES ET UNE TAILLE ADAPTÉE AUX MAINS DES ENFANTS POUR FAIRE DE LEUR REPAS UN MOMENT EXQUIS

SOFT LINES AND A CHILD-FRIENDLY SIZE TO MAKE CHILDREN'S MEALTIMES A MAGIC MOMENT

LÍNEAS SUAVES Y UN TAMAÑO ADAPTADO A LAS MANOS DE LOS NIÑOS PARA CONVERTIR LA COMIDA EN UN MOMENTO EXQUISITO



18-10

2,5



Possibilité de personnalisation  
Bespoke options available - Posibilidad de personalización



---

## PLATERIE

---

A travers des objets en acier dédiés à la table, au service et à la dégustation, DEGRENNE exprime la richesse de son métier d'orfèvre. Des pièces de forme aux **lignes raffinées** jusqu'aux accessoires présentés sur la table des convives, **la collection platerie DEGRENNE s'accorde parfaitement avec l'ensemble des gammes** pour offrir un **service élégant et moderne**.

---

### HOLLOWARE

---

DEGRENNE expresses its highly-varied metal-working expertise through steel products designed for the table, service and tasting and appreciating. From shaped pieces with **sophisticated lines** to accessories showcased on the guests' table, **DEGRENNE's holloware collection fits perfectly with all the other ranges**, making for an **elegant and contemporary service**.

---

### ORFEBRERÍA

---

A través de los objetos de acero dedicados a la mesa, al servicio y a la degustación, DEGRENNE expresa la riqueza de su oficio de orfebre. Desde piezas de forma con **líneas refinadas** hasta accesorios presentados en la mesa de los invitados, **la colección de platería DEGRENNE combina perfectamente con el conjunto de las gamas** para ofrecer un **servicio elegante y moderno**.

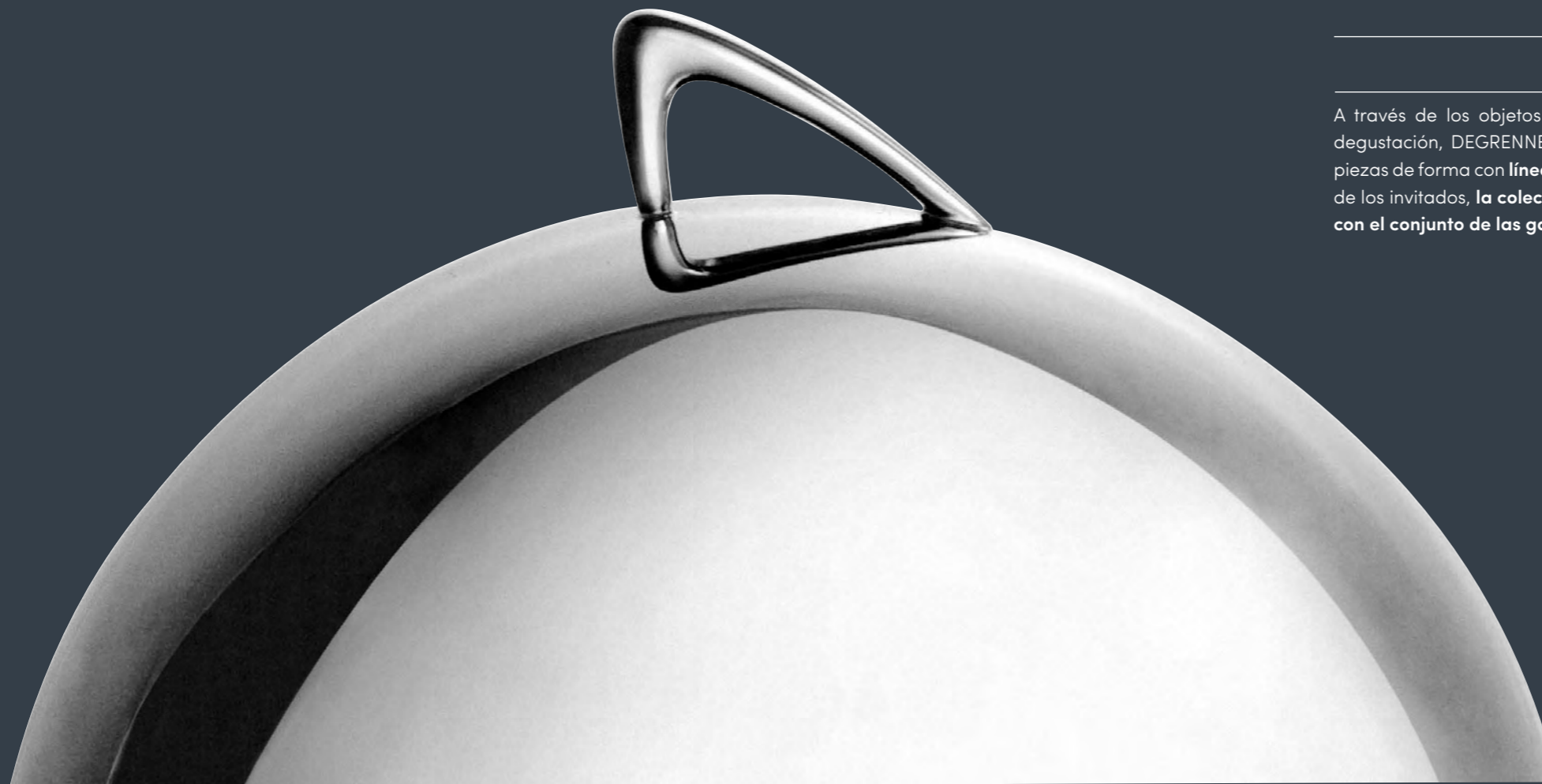



185018 186458   
238953(2) 238963(2)   
**PLATEAU RECTANGULAIRE AVEC ANSES**  
RECTANGULAR SERVING TRAYS WITH HANDLES  
BANDEJA RECTANGULAR CON ASAS  
EXT : 77 X 55 CM - 30 IN<sup>3/16</sup> X 21 IN<sup>5/8</sup>  
INT : 68,5 X 46,5 CM - 26 IN<sup>15/16</sup> X 18 IN<sup>5/16</sup>

185023 186459   
238954(2) 238964(2)   
**PLATEAU RECTANGULAIRE AVEC ANSES GASTRONORM 2/1**  
RECTANGULAR SERVING TRAYS WITH HANDLES  
BANDEJA RECTANGULAR CON ASAS  
EXT : 65 X 53 CM - 25 IN<sup>3/16</sup> X 20 IN<sup>7/8</sup>  
INT : 56,5 X 44,5 CM - 22 IN<sup>1/4</sup> X 17 IN<sup>1/2</sup>

185022 186460   
238955(2) 238965(2)   
**PLATEAU RECTANGULAIRE AVEC ANSES**  
RECTANGULAR SERVING TRAYS WITH HANDLES  
BANDEJA RECTANGULAR CON ASAS  
EXT : 60 X 40 CM - 23 IN<sup>3/8</sup> X 15 IN<sup>3/4</sup>  
INT : 51,5 X 31,5 CM - 20 IN<sup>1/4</sup> X 12 IN<sup>3/8</sup>



185021 186461   
238962(1) 238972(1)   
**PLATEAU RECTANGULAIRE SANS ANSES GASTRONORM 1/1**  
RECTANGULAR SERVING TRAYS WITHOUT HANDLES  
BANDEJA RECTANGULAR SIN ASAS  
EXT : 53 X 32,5 CM - 20 IN<sup>7/8</sup> X 12 IN<sup>13/16</sup>  
INT : 46,5 X 26 CM - 18 IN<sup>5/16</sup> X 10 IN<sup>1/4</sup>

185020 186462   
238961(1) 238971(1)   
**PLATEAU RECTANGULAIRE SANS ANSES**  
RECTANGULAR SERVING TRAYS WITHOUT HANDLES  
BANDEJA RECTANGULAR SIN ASAS  
EXT : 40 X 27 CM - 15 IN<sup>3/4</sup> X 10 IN<sup>5/8</sup>  
INT : 33,5 X 20,5 CM - 13 IN<sup>3/16</sup> X 8 IN<sup>1/16</sup>

185019 186463   
238960(1) 238970(1)   
**PLATEAU RECTANGULAIRE SANS ANSES GASTRONORM 1/2**  
RECTANGULAR SERVING TRAYS WITHOUT HANDLES  
BANDEJA RECTANGULAR SIN ASAS  
EXT : 32,5 X 26,5 CM - 12 IN<sup>13/16</sup> X 10 IN<sup>7/16</sup>  
INT : 26 X 20 CM - 10 IN<sup>1/4</sup> X 7 IN<sup>7/8</sup>

227767 227768   
**PLATEAU RECTANGULAIRE SANS ANSES**  
RECTANGULAR SERVING TRAYS WITHOUT HANDLES  
BANDEJA RECTANGULAR SIN ASAS  
EXT : 22 X 14 CM - 8 IN<sup>10/16</sup> X 5 IN<sup>1/2</sup>  
INT : 20 X 12 CM - 7 IN<sup>7/8</sup> X 4 IN<sup>3/4</sup>



185024 186457   
**PLATEAU ROND**  
ROUND TRAY  
BANDEJA REDONDA  
INT : 42 CM - 16 IN<sup>3/16</sup>  
EXT : 35,1 CM - 13 IN<sup>13/16</sup>



232972   
**PLATEAU RECTANGULAIRE**  
RECTANGULAR SERVING TRAY  
BANDEJA RECTANGULAR  
INT : 26 X 18 CM - 10 IN<sup>13/16</sup> X 7 IN<sup>1/16</sup>  
EXT : 23 X 15 CM - 9 IN<sup>1/16</sup> X 5 IN<sup>7/8</sup>

(1) Nouveaux codes à partir du 01/04/2020  
New codes valid from 2020/04/01  
Nuevos codigos a partir de 01/04/2020

(2) Nouveaux codes à partir du 01/07/2020  
New codes valid from 2020/07/01  
Nuevos codigos a partir de 01/07/2020



**PLATEAUX EMPILABLES - STACKABLE SERVING TRAYS**  
**APILABLES BANDEJAS**

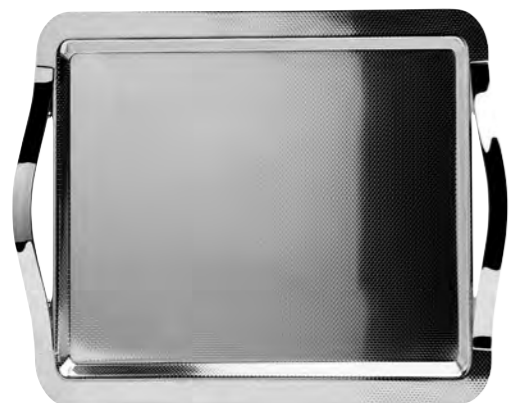

211886 213857   
 238987(1) 238990(1)   
**PLATEAU RECTANGULAIRE AVEC ANSES GASTRONORM 2/1**  
 RECTANGULAR SERVING TRAYS WITH HANDLES  
 BANDEJA RECTANGULAR CON ASAS  
 EXT : 65 X 53 CM - 25 IN<sup>5/16</sup> X 20 IN<sup>7/8</sup>  
 INT : 56,5 X 44,5 CM - 22 IN<sup>1/4</sup> X 17 IN<sup>1/2</sup>



211887 213858   
 238988(1) 238990(1)   
**PLATEAU RECTANGULAIRE AVEC ANSES**  
 RECTANGULAR SERVING TRAYS WITH HANDLES  
 BANDEJA RECTANGULAR CON ASAS  
 EXT : 60 X 40 CM - 23 IN<sup>5/8</sup> X 15 IN<sup>3/4</sup>  
 INT : 51,5 X 31,5 CM - 20 IN<sup>1/4</sup> X 12 IN<sup>3/8</sup>



211888 213859   
**PLATEAU RECTANGULAIRE SANS ANSES GASTRONORM 1/2**  
 RECTANGULAR SERVING TRAYS WITHOUT HANDLES  
 BANDEJA RECTANGULAR SIN ASAS  
 EXT : 32,5 X 26,5 CM - 12 IN<sup>3/8</sup> X 10 IN<sup>7/16</sup>  
 INT : 26 X 20 CM - 10 IN<sup>1/4</sup> X 7 IN<sup>7/8</sup>

211889 213860   
**PLATEAU RECTANGULAIRE SANS ANSES**  
 RECTANGULAR SERVING TRAYS WITHOUT HANDLES  
 BANDEJA RECTANGULAR SIN ASAS  
 EXT : 22 X 14 CM - 8 IN<sup>11/16</sup> X 5 IN<sup>1/2</sup>  
 INT : 20 X 12 CM - 7 IN<sup>7/8</sup> X 4 IN<sup>3/4</sup>



230872 230874   
**DESSOUS DE BOUTEILLE**  
 BOTTLE COASTER  
 POSABOTELLA  
 13,5 CM - 5 IN<sup>5/16</sup>

(1) Nouveaux codes à partir du 01/06/2020  
 New codes valid from 2020/06/01  
 Nuevos códigos a partir de 01/06/2020



©Julie ANSIAU

Le abus d'alcool est dangereux pour la santé.  
 Excessive alcohol consumption is responsible for many deaths and liver damage.  
 El abuso de alcohol es peligroso para la salud.





183019 186451  
238958(1) 238968(1)  
**PLAT OVALE**  
OVAL DISH  
FUENTE OVALADA  
EXT : 46 X 31 CM - 18 IN<sup>1/8</sup> X 12 IN<sup>3/16</sup>  
INT : 25,9 X 13,9 CM - 10 IN<sup>3/16</sup> X 5 IN<sup>1/2</sup>



183018 186450  
238957(1) 238967(1)  
**PLAT OVALE**  
OVAL DISH  
FUENTE OVALADA  
EXT : 41 X 28 CM - 16 IN<sup>1/8</sup> X 11 IN  
INT : 28,7 X 15,6 CM - 11 IN<sup>5/16</sup> X 6 IN<sup>1/8</sup>



183017 186449  
238956(1) 238966(1)  
**PLAT OVALE**  
OVAL DISH  
FUENTE OVALADA  
EXT : 38 X 25 CM - 14 IN<sup>15/16</sup> X 9 IN<sup>13/16</sup>  
INT : 26,6 X 16,3 CM - 10 IN<sup>1/2</sup> X 6 IN<sup>7/16</sup>



220120 220121  
**PLAT ROND CREUX**  
ROUND DEEP DISH  
BANDEJA REDONDA  
EXT : 33,5 CM - 13 IN<sup>3/16</sup>  
INT : 20 CM - 7 IN<sup>7/8</sup>



183021 186453  
238959(1) 238969(1)  
**PLAT À POISSON**  
FISH DISH  
FUENTE PARA PESCADO  
EXT : 60 X 27 CM - 23 IN<sup>5/8</sup> X 10 IN<sup>5/8</sup>  
INT : 46,3 X 14,3 CM - 18 IN<sup>1/4</sup> X 5 IN<sup>5/8</sup>



186198 186456  
**SAUCIÈRE**  
SAUCE BOAT  
SALSERA  
19 X 7,6 CM - 7 IN<sup>1/2</sup> X 3 IN  
20 CL - 6 OZ<sup>3/4</sup>



185307 186455  
**BEURRIER**  
BUTTER DISH  
MANTEQUILLERA INDIV.  
Ø 7,6 X 7 CM  
Ø 3 IN X 2 IN<sup>3/4</sup>



190255  
**SOCLE BEURRIER  
PORCELAINE**  
BUTTER DISH BASE PORCELAIN  
MANTEQUILLERA SIN TAPA  
Ø 9 X 7,6 CM  
Ø 3 IN X 2 IN<sup>3/4</sup>



211397  
**PORTE SUCRE  
CENTRE DE TABLE**  
SUGAR HOLDER/TABLE  
CENTERPIECE  
CENTRO DE MESA  
Ø 6,4 X H 6 CM  
Ø 2 IN<sup>1/2</sup> X H 2 IN<sup>3/8</sup>



208862  
**PORTE SUCRE  
CENTRE DE TABLE**  
SUGAR HOLDER/TABLE  
CENTERPIECE  
CENTRO DE MESA  
Ø 5 X H 6 CM  
Ø 1 IN<sup>5/16</sup> X H 2 IN<sup>3/8</sup>

(1) Nouveaux codes à partir du 01/04/2020  
New codes valid from 2020/04/01  
Nuevos codigos a partir de 01/04/2020





213850 ■ 219563  
**VERSEUSE**  
COFFEE/TEA POT  
CAFETERA/TETERA  
1,5 L - 50 OZ<sup>3/4</sup>  
18,1 CM X H 22,4 CM  
7 IN<sup>1/2</sup> X H 8 IN<sup>13/16</sup>



213851 ■ 219564  
**VERSEUSE**  
COFFEE/TEA POT  
CAFETERA/TETERA  
70 CL - 23 OZ<sup>1/16</sup>  
14,8 CM X H 14,6 CM  
5 IN<sup>13/16</sup> X H 5 IN<sup>3/4</sup>



213852 ■ 219565  
**VERSEUSE**  
COFFEE/TEA POT  
CAFETERA/TETERA  
35 CL - 11 OZ<sup>13/16</sup>  
12,9 CM X H 9,3 CM  
5 IN<sup>1/16</sup> X H 3 IN<sup>11/16</sup>



213849 ■ 219561  
**PICHET**  
JUG  
JARRA  
2 L - 67 OZ<sup>5/8</sup>  
18,1 CM X H 23 CM  
7 IN<sup>1/8</sup> X H 9 IN<sup>1/16</sup>

POT ISOTHERME - INSULATED POT - JARRA ISOTÉRMICA



213846 ■ 219557  
**POT ISOTHERME**  
INSULATED POT  
JARRA ISOTÉRMICA  
1,2 L - 40 OZ<sup>23/16</sup>  
18,1 CM X H 22,7 CM  
7 IN<sup>1/8</sup> X H 8 IN<sup>15/16</sup>



213847 ■ 219558  
**POT ISOTHERME**  
INSULATED POT  
JARRA ISOTÉRMICA  
70 CL - 23 OZ<sup>1/4</sup>  
15,6 CM X H 19,2 CM  
6 IN<sup>1/8</sup> X H 7 IN<sup>9/16</sup>



213848 ■ 219559  
**POT ISOTHERME**  
INSULATED POT  
JARRA ISOTÉRMICA  
30 CL - 40 OZ  
13,4 CM X H 12,7 CM  
5 IN<sup>1/4</sup> X H 5 IN



213853 ■ 219566  
**CRÉMIER**  
CREAM JUG  
LECHERA  
35 CL - 11 OZ<sup>13/16</sup>  
12,9 CM X H 9 CM  
5 IN<sup>1/16</sup> X H 3 IN<sup>9/16</sup>



213854 ■ 219567  
**CRÉMIER**  
CREAM JUG  
LECHERA  
15 CL - 5 OZ<sup>1/16</sup>  
9 CM X H 9 CM  
3 IN<sup>9/16</sup> X H 3 IN<sup>9/16</sup>



182341 ■ 184612  
**SUCRIER**  
SUGAR BOWL  
AZUCARERO  
35 CL - 11 OZ<sup>13/16</sup>

NEWPORT P. 90-91



002191 ■ 129797  
**PINCE À SUCRE**  
SUGAR TONG  
PINZAS PARA AZÚCAR  
11,5 CM - 4 IN<sup>1/2</sup>



©Julie ANSIAU - Photo non contractuelle





184180 188895   
**SEAU À CHAMPAGNE  
2 BOUTEILLES**  
CHAMPAGNE BUCKET 2 BOTTLES  
CHAMPANERA 2 BOTELLAS  
Ø 24 X H 25,5 CM  
Ø 9 IN<sup>7/16</sup> X H 10 IN<sup>1/16</sup>



186030 188894   
**SEAU À CHAMPAGNE  
1 BOUTEILLE**  
CHAMPAGNE BUCKET 1 BOTTLE  
CHAMPANERA 1 BOTELLA  
Ø 20 X H 22,5 CM  
Ø 7 IN<sup>7/8</sup> X H 8 IN<sup>7/8</sup>



184181 188896   
**SEAU À GLACE  
AVEC COUVERCLE**  
ICE BUCKET WITH LID  
CUBITERA CON TAPA  
Ø 15 X H 16 CM  
Ø 5 IN<sup>7/8</sup> X H 6 IN<sup>5/16</sup>



**NEW**  
237501   
**RAFRAICHISSEUR DROIT DOUBLE PARI**  
CURVED DOUBLE WALL WINE COOLER  
ENFRIADOR DE BOTELLA DOBLE PARED  
Ø 13,9 X H 19,8 CM  
Ø 5 IN<sup>7/8</sup> X H 7 IN<sup>13/16</sup>



004014  
**PINCE À GLACE**  
ICE TONG  
PINZA PARA HIELO  
16 CM - 6 IN<sup>5/16</sup>



185607 188893   
**PORTE SEAU À CHAMPAGNE  
(1 OU 2 BOUTEILLES)**  
CHAMPAGNE BUCKET STAND  
(1 OR 2 BOTTLES)  
PORTACUBO (1/2 BOTELLAS)  
H 63,5 CM - 25 IN



216919   
**VERRINE SEL AIMANTÉE**  
SALT CELLAR W/MAGNET  
SALERO CON IMÁN  
4,1 X 6,7 CM  
1 IN<sup>5/8</sup> X 2 IN<sup>5/8</sup>



216920   
**VERRINE POIVRE AIMANTÉE**  
PEPPER CELLAR W/MAGNET  
PIMENTERO CON IMÁN  
4,1 X 6,7 CM  
1 IN<sup>5/8</sup> X 2 IN<sup>5/8</sup>



216922   
**ENSEMBLE SEL & POIVRE AIMANTÉ**  
SALT & PEPPER CELLAR W/MAGNET  
CONJUNTO SALERO/PIMENTERO CON IMÁN  
8,5 X 10,6 CM - 3 IN<sup>1/8</sup> X 4 IN<sup>1/16</sup>

L'abus d'alcool est dangereux pour la santé.  
Degréne promises responsible drinking and discourages alcohol misuse.  
El abuso de alcohol es peligroso para la salud.





EMPILABLES - STACKABLE - APILABLES



182614 + 184477  
**CLOCHE ASSIETTE**  
DOME COVER, STAINLESS STEEL,  
CAMPANA  
Ø 24 CM - 9 IN<sup>7/16</sup>

182301 + 184476  
**CLOCHE ASSIETTE**  
DOME COVER, STAINLESS STEEL  
CAMPANA  
Ø 14,8 CM - 5 IN<sup>3/16</sup>



044113 + 101512  
**CLOCHE ASSIETTE**  
DOME COVER, STAINLESS STEEL  
CAMPANA  
Ø 26 CM - 10 IN<sup>1/4</sup>

044112 + 101510  
**CLOCHE ASSIETTE**  
DOME COVER, STAINLESS STEEL  
CAMPANA  
Ø 22 CM - 8 IN<sup>7/8</sup>



206504  
**BOUCHON PORCELAINE POUR CLOCHE VERRE**  
PORCELAIN LID FOR GLASS DOME COVER  
TAPA DE PORCELANA PARA CAMPANA DE VIDRIO  
5,2 CM - 2 IN<sup>1/16</sup>

204043  
**CLOCHE VERRE BOROSILICATE**  
GLASS DOME COVER  
CAMPANA VIDRIO BOROSILICATO  
17X9 CM - 6 IN<sup>11/16</sup> X 3 IN<sup>9/16</sup>



120522 + 131115  
**CORBEILLE À PAIN RONDE EN FIL**  
ROUND BREAD BASKET  
PANERA REDONDA  
Ø 20,5 X H 7,5 CM  
Ø 8 IN<sup>1/16</sup> X H 2 IN<sup>15/16</sup>

128910 + 131114  
**CORBEILLE À PAIN RONDE EN FIL**  
ROUND BREAD BASKET  
PANERA REDONDA  
Ø 17,5 X H 6 CM  
Ø 6 IN<sup>7/8</sup> X H 2 IN<sup>3/8</sup>

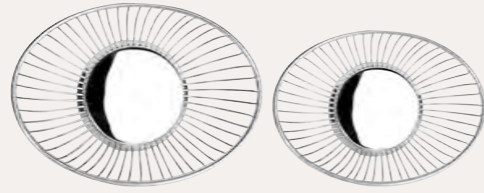

128912 + 131117  
**CORBEILLE À PAIN OVALE EN FIL**  
OVAL BREAD BASKET  
PANERA OVALADA  
Ø 24 X 17 CM - H 7,5 CM  
Ø 9 IN<sup>7/8</sup> X 6 IN<sup>11/16</sup> - H 2 IN<sup>15/16</sup>

128911 + 131118  
**CORBEILLE À PAIN OVALE EN FIL**  
OVAL BREAD BASKET  
PANERA OVALADA  
Ø 20 X 15 CM - H 6 CM  
Ø 7 IN<sup>7/8</sup> X 5 IN<sup>7/8</sup> - H 2 IN<sup>3/8</sup>



164138  
**PLAT À ESCARGOTS**  
SNAIL TRAY 6 SPACES  
BANDEJA CARACOLAS 6 COMPARTIMENTOS  
16,6 CM - 6 IN<sup>9/16</sup>



168845 +  
**CUILLÈRE À SPAGHETTI**  
SPAGHETTI SERVING SPOON  
CUCHARA PARA ESPAGUETIS  
29 CM - 11 IN<sup>7/16</sup>



168844 +  
**FOURCHETTE À VIANDE**  
MEAT FORK  
TENEDOR DE CARNE  
29 CM - 11 IN<sup>7/16</sup>



159597 + 101453  
**BOL RINCE DOIGTS**  
FINGER BOWL  
LAVADEDOS  
Ø 11 X H 4 CM  
Ø 4 IN<sup>5/16</sup> X H 1 IN<sup>9/16</sup>



004013 +  
**PINCE À ESCARGOTS**  
SNAIL TONG  
PINZAS CARACOLAS  
16 CM - 6 IN<sup>5/16</sup>



204497 + 101493  
**PINCE À HOMARD**  
LOBSTER CRACKER  
TENACILLAS PARA BOGAVANTE  
18,5 CM - 7 IN<sup>5/16</sup>

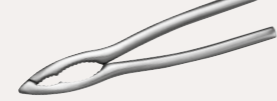

184492 +  
**PINCE À CRUSTACÉ**  
SEAFOOD CRACKER  
TENACILLAS PARA CRUSTACEOS  
16,5 CM - 6 IN<sup>1/2</sup>



204496 + 101494  
**CISEAUX À GÂTEAUX**  
PASTRY SCISSORS/TONG  
PINZAS PARA SCISSORS  
20 CM - 7 IN<sup>7/8</sup>



204499 + 184355  
**PINCE À SERVIR**  
SERVING TONG  
PINZAS PARA SERVIR  
29,5 CM - 11 IN<sup>5/8</sup>



204498 + 101492  
**PINCE À PAIN**  
BREAD TONG  
PINZAS PAN  
23 CM - 9 IN<sup>1/16</sup>

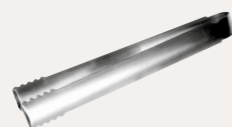

004014 +  
**PINCE À GLACE**  
ICE TONG  
PINZAS PARA HIELO  
16 CM - 6 IN<sup>5/16</sup>



002191 + 129797  
**PINCE À SUCRE**  
SUGAR TONG  
PINZA PARA AZÚCAR  
11,5 CM - 4 IN<sup>1/2</sup>



130994 +  
**CUILLÈRE À TOASTS**  
APPETIZER SPOON  
CUCHARA APERITIVO  
11,8 CM - 7 IN<sup>7/16</sup>





---

## VERRES

---

Les collections de verres DEGRENNE invitent au partage et à la dégustation. Leurs qualités esthétiques ainsi que leur résistance exceptionnelle, garantissent une utilisation en toute occasion. Pour compléter harmonieusement la table, les verres de couleur DEGRENNE, teintés dans la masse, offrent une esthétique et une qualité à l'épreuve du temps et des lavages au lave-vaisselle.

---

### GLASSWARE

---

DEGRENNE'S glassware collections are an invitation to socialize and enjoy a drink. Our glassware's looks and exceptional sturdiness mean that it can be used at any occasion. DEGRENNE's integrally dyed glasses are a harmonious addition to the dining table and offer looks and quality that withstand the test of time and repeated washing in the dishwasher. Each hand-blown glass is unique!

---

### CRISTALERÍA

---

Las colecciones de copas DEGRENNE invitan a compartir y a degustar. Sus cualidades estéticas así como su resistencia, excepcional, garantizan un uso en cualquier ocasión. Para completar la mesa con armonía, las copas de color DEGRENNE, pintadas en masa, ofrecen una estética y una calidad que supera el paso del tiempo y los lavados en el lavavajillas. Soplada en boca de manera artesanal, ¡cada pieza es única!



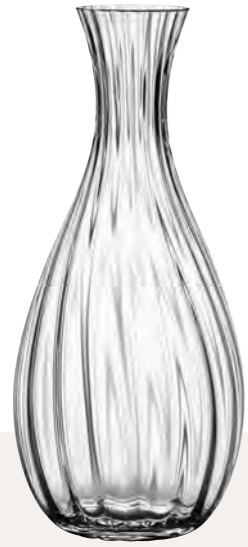

236752  
**CARAFE**  
CARAFE  
BOTELLA  
1,1 L - 37 OZ<sup>3/16</sup>  
Ø 5,2 X H 25,3 CM  
Ø 2 IN<sup>7/16</sup> X H 9 IN<sup>15/16</sup>



234102  
**FLÛTE À CHAMPAGNE**  
CHAMPAGNE FLUTE  
FLAUTA CHAMPÁN  
13 CL - 4 OZ<sup>2/8</sup>  
Ø 5 X H 21,7 CM  
Ø 1 IN<sup>5/16</sup> X H 8 IN<sup>9/16</sup>



234104  
**VERRE À VIN BLANC**  
WHITE WINE GLASS  
COPA DE VINO BLANCO  
25 CL - 8 OZ<sup>7/16</sup>  
Ø 7 X H 20 CM  
Ø 2 IN<sup>3/4</sup> X H 8 IN<sup>1/4</sup>



234103  
**VERRE À VIN ROUGE**  
RED WINE GLASS  
COPA DE VINO TINTO  
40 CL - 13 OZ<sup>2/2</sup>  
Ø 8,3 X H 21,7 CM  
Ø 3 IN<sup>1/4</sup> X H 8 IN<sup>9/16</sup>



184561  
**VERRE À EAU À PIED**  
STEMMED GLASS  
COPA DE AGUA  
25 CL - 8 OZ<sup>7/16</sup>  
Ø 7,3 X H 12 CM  
Ø 2 IN<sup>7/8</sup> X H 4 IN<sup>3/4</sup>



234106  
**GOBELET BAS**  
LOW TUMBLER  
VASO BAJO  
33 CL - 11 OZ<sup>1/16</sup>  
Ø 7,9 X H 9,5 CM  
Ø 3 IN<sup>1/8</sup> X H 3 IN<sup>3/4</sup>

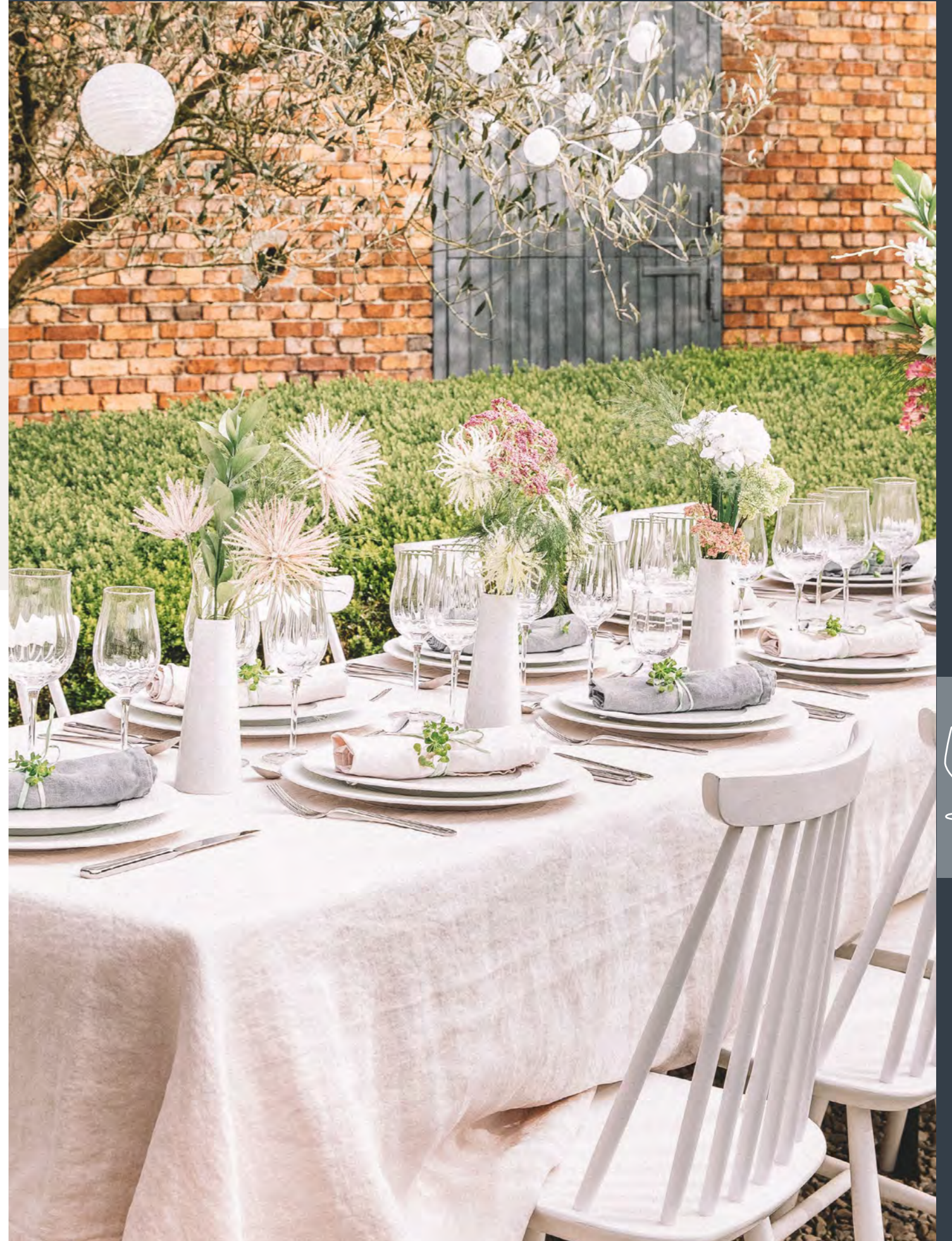
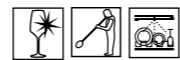



184584  
**FLÛTE À CHAMPAGNE**  
CHAMPAGNE FLUTE  
FLAUTA CHAMPÁN  
27 CL - 9 OZ<sup>1/8</sup>  
Ø 8 X H 24,3 CM  
Ø 3 IN<sup>1/8</sup> X H 9 IN<sup>3/16</sup>



184583  
**VERRE À VIN BLANC**  
WHITE WINE GLASS  
COPA DE VINO BLANCO  
35 CL - 11 OZ<sup>13/16</sup>  
Ø 8 X H 22,3 CM  
Ø 3 IN<sup>1/8</sup> X H 8 IN<sup>3/4</sup>



184582  
**VERRE À VIN ROUGE**  
RED WINE GLASS  
COPA DE VINO TINTO  
42 CL - 14 OZ<sup>17/16</sup>  
Ø 8,3 X H 23,1 CM  
Ø 3 IN<sup>1/4</sup> X H 9 IN<sup>1/8</sup>



184581  
**VERRE À EAU**  
WATER GLASS  
COPA DE AGUA  
48 CL - 16 OZ<sup>1/4</sup>  
Ø 8,9 X H 23,5 CM  
Ø 3 IN<sup>1/2</sup> X H 9 IN<sup>1/4</sup>



©Julie ANSIAU





184551  
**FLÛTE À CHAMPAGNE**  
CHAMPAGNE FLUTE  
FLAUTA CHAMPÁN  
19 CL - 6 OZ<sup>1/16</sup>  
Ø 6,3 X H 22,4 CM  
Ø 2 IN<sup>1/2</sup> X H 8 IN<sup>3/16</sup>



184549  
**VERRE À VIN BLANC**  
WHITE WINE GLASS  
COPA DE VINO BLANCO  
28 CL - 9 OZ<sup>1/16</sup>  
Ø 7,4 X H 20,8 CM  
Ø 2 IN<sup>5/16</sup> X H 8 IN<sup>1/16</sup>



184548  
**VERRE À VIN ROUGE**  
RED WINE GLASS  
COPA DE VINO TINTO  
35 CL - 11 OZ<sup>3/16</sup>  
Ø 8 X H 21,4 CM  
Ø 3 IN<sup>1/16</sup> X H 8 IN<sup>1/16</sup>



184547  
**VERRE À EAU**  
WATER GLASS  
COPA DE AGUA  
45 CL - 15 OZ<sup>3/16</sup>  
Ø 8,4 X H 22,5 CM  
Ø 3 IN<sup>5/16</sup> X H 8 IN<sup>1/16</sup>



184550  
**VERRE À BORDEAUX**  
BORDEAUX GLASS  
COPA DE CAVA  
64,5 CL - 21 OZ<sup>13/16</sup>  
Ø 9,5 X H 23,8 CM  
Ø 3 IN<sup>3/4</sup> X H 9 IN<sup>3/8</sup>



210812  
**VERRE À BOURGOGNE**  
BURGUNDY GLASS  
COPA BOURGOGNE  
70 CL - 23 OZ<sup>1/16</sup>  
Ø 10,5 X H 23,1 CM  
Ø 4 IN<sup>1/8</sup> X H 9 IN<sup>1/8</sup>



184555  
**GOBELET HAUT**  
HIGH TUMBLER  
VASO ALTO  
36 CL - 12 OZ<sup>1/16</sup>  
Ø 6,8 X H 14,2 CM  
Ø 2 IN<sup>1/16</sup> X H 5 IN<sup>9/16</sup>



184554  
**GOBELET BAS**  
LOW TUMBLER  
VASO BAJO  
33 CL - 11 OZ<sup>1/16</sup>  
Ø 8 X H 10,2 CM  
Ø 3 IN<sup>1/16</sup> X H 4 IN



184553  
**GOBELET BAS**  
LOW TUMBLER  
VASO BAJO  
23 CL - 7 OZ<sup>1/4</sup>  
Ø 7,6 X H 9,2 CM  
Ø 3 IN X H 3 IN<sup>5/8</sup>



184552  
**GOBELET BAS/VERRINE**  
LOW TUMBLER/APPETIZER GLASS  
VASO BAJO/VASITOS  
15 CL - 5 OZ<sup>1/16</sup>  
Ø 6,4 X H 8 CM  
Ø 2 IN<sup>1/2</sup> X H 3 IN<sup>1/8</sup>



@Patrick ROUGEREAU  
L'alcool est dangereux pour la santé.  
Engrima prometer responsable drinking and discourages alcohol misuse.  
El abuso de alcohol es peligroso para la salud.





184556  
**FLÛTE À CHAMPAGNE**  
CHAMPAGNE FLUTE  
FLAUTA CHAMPÁN  
20 CL - 6 OZ<sup>3/4</sup>  
Ø 6,7 X H 21,2 CM  
Ø 2 IN<sup>5/8</sup> X H 8 IN<sup>3/8</sup>

190537  
**VERRE À VIN**  
WINE GLASS  
COPA DE VINO  
35 CL - 11 OZ<sup>3/8</sup>  
Ø 7,8 X H 19,6 CM  
Ø 3 IN<sup>1/16</sup> X H 7 IN<sup>1/16</sup>

190536  
**VERRE À EAU**  
WATER GLASS  
COPA DE AGUA  
45 CL - 15 OZ<sup>3/8</sup>  
Ø 8,4 X H 20,5 CM  
Ø 3 IN<sup>5/16</sup> X H 8 IN<sup>1/16</sup>

190538  
**GOBELET**  
TUMBLER  
VASO  
47 CL - 15 OZ<sup>7/8</sup>  
Ø 8,5 X H 12,1 CM  
Ø 3 IN<sup>3/8</sup> X H 4 IN<sup>3/4</sup>



DÉCOR TAILLÉ DANS LE VERRE  
CUT-GLASS DESIGN  
DECORACIÓN TALLADA EN CRISTAL



Relais Bernard LOISEAU

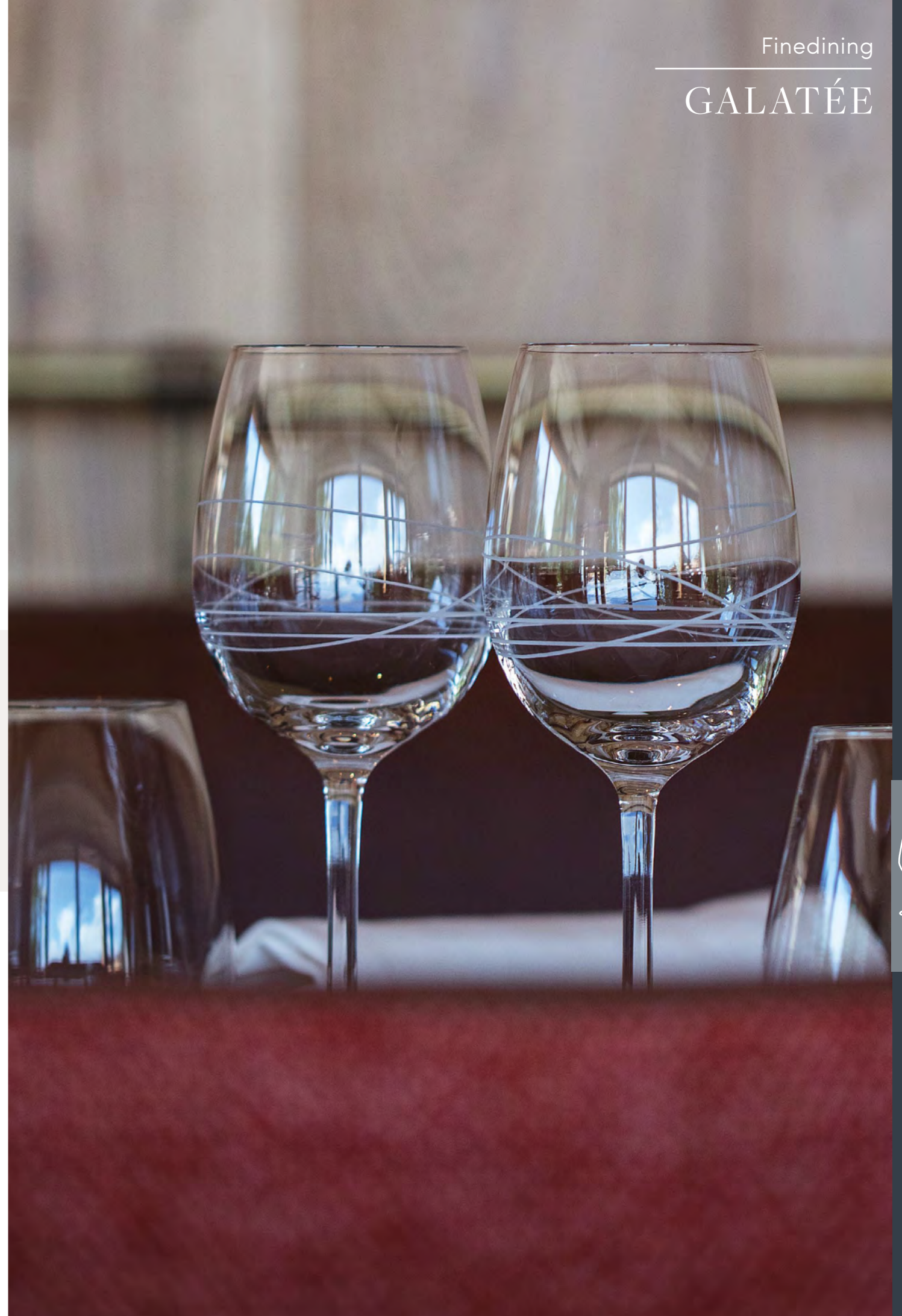



DEGRENNÉ S'EST ASSOCIÉ À **MANUEL PEYRONNET**, MEILLEUR OUVRIER DE FRANCE SOMMELIER 2013 POUR CRÉER **ORIGINE**, LA PREMIÈRE GAMME DE 5 VERRES À PIED PERMETTANT D'ASSOCIER DE MANIÈRE SIMPLE ET ÉVIDENTE UN VIN AVEC LE BON VERRE.

DEGRENNÉ HAS JOINED FORCES WITH **MANUEL PEYRONNET**, THE 2013 WINNER OF THE PRESTIGIOUS MEILLEUR OUVRIER DE FRANCE SOMMELIER AWARD, TO CREATE **ORIGINE**, THE FIRST RANGE OF FIVE STEMMED GLASSES, MAKING IT EASY TO CHOOSE THE RIGHT GLASS FOR YOUR WINE.

DEGRENNÉ SE HA ASOCIADO CON **MANUEL PEYRONNET**, EL MEJOR OBRADOR DE FRANCIA SUMILLER DE 2013 PARA CREAR **ORIGINE**, LA PRIMERA GAMA DE 5 COPAS DE VINO, QUE PERMITE ASOCIAR DE MANERA SENCILLA Y EVIDENTE UN VINO CON LA COPA ADECUADA.

N°1

CHAMPAGNE  
PROSECCO



216733  
**EFFERVESCENCE**  
EFFERVESCENCE  
ESPUMA  
22,5 CL - 7 OZ<sup>5/16</sup>  
Ø 7,1 X H 21 CM  
Ø 2 IN<sup>3/16</sup> X H 8 IN<sup>1/4</sup>

N°2

RIESLING, SAUVIGNON,  
CHENIN, GAMAY,  
CABERNET, FRANC



216730  
**FRAÎCHEUR**  
FRESHNESS  
FRESQUERA  
50 CL - 16 OZ<sup>5/16</sup>  
Ø 8,9 X H 21,5 CM  
Ø 3 IN<sup>1/2</sup> X H 8 IN<sup>7/16</sup>

N°3

GRENACHE, MERLOT,  
MALBEC, SYRHA  
CABERNET SAUVIGNON



216731  
**PUISSANCE**  
STRENGTH  
POTENCIA  
50 CL - 16 OZ<sup>5/16</sup>  
Ø 9,5 X H 21,5 CM  
Ø 3 IN<sup>3/4</sup> X H 8 IN<sup>7/16</sup>

N°4

PINOT NOIR,  
CHARDONNAY,  
BOURGOGNE



216732  
**SUBTILITÉ**  
SUBTLETY  
SUTILEZA  
60 CL - 20 OZ<sup>5/16</sup>  
Ø 10,2 X H 21,5 CM  
Ø 4 IN X H 8 IN<sup>7/16</sup>

N°5

POUR LES VINS MOELLEUX ET LIQUEUREUX  
FOR SWEET & SYRUPY WINES  
PARA LOS VINOS MELOSOS  
Y LICOROSOS



216734  
**DOUCEUR**  
SWEETNESS  
DULZOR  
20 CL - 6 OZ<sup>3/4</sup>  
Ø 6,9 X H 20 CM  
Ø 2 IN<sup>11/16</sup> X H 7 IN<sup>7/16</sup>

**OUVERTURE DU BUVANT**  
THE OPENING OF THE RIM  
LA APERTURA DE LA BOCA



**POUR AFFIRMER  
LA TEXTURE DU VIN**  
AFFIRM THE WINE'S  
TEXTURE  
PARA AFIRMAR  
LA TEXTURA DEL VINO

**HAUTEUR DE PARAISON**  
THE HEIGHT OF THE BULB  
LA ALTURA DEL FONDO



**POUR JOUER SUR  
L'EXPANSION DES BOUQUETS**  
ALLOW THE BOUQUETS TO  
FLOURISH  
PARA JUGAR SOBRE LA  
AMPLIACIÓN DE LOS BUQUÉS

**DIAMÈTRE DE PARAISON**  
THE DIAMETER OF THE BULB  
EL DIÁMETRO DEL FONDO

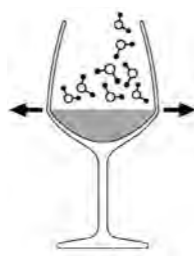

**POUR LAISSER LE VIN  
S'OXYGÉNER**  
ALLOW THE WINE TO  
AERATE  
PARA DEJAR QUE EL VINO  
OXIGENE

**3 LEVIERS ONT ÉTÉ IDENTIFIÉS**  
3 KEY FACTORS WERE IDENTIFIED  
SE HAN IDENTIFICADO 3 PARÁMETROS

**HAUTEUR COMPATIBLE LAVE-VAISSELLE**  
DISHWASHER COMPATIBLE HEIGHT  
ALTURA COMPATIBLE CON LAVA-VAJILLAS

**SERVICE FACILITÉ PAR LA JAUGE NATURELLE DE 12 CL**  
SERVICE IS FACILITATED BY THE 12 CL MARKING  
SERVICIO FACILITADO POR EL INDICADOR DE NIVEL NATURAL DE 12 CL



©Julie ANSIAU

Le bus d'alcool est dangereux pour la santé  
Degrenne promotes responsible drinking and discourages alcohol misuse  
El abuso de alcohol es peligroso para la salud





- |  |   |  |   |  |  |
|--|---|--|---|--|--|
| <p>184566<br/><b>FLÛTE À CHAMPAGNE</b><br/>CHAMPAGNE FLUTE<br/>FLAUTA CHAMPÁN<br/>19 CL - 6 OZ<sup>7/16</sup><br/>Ø 5,3 X H 21,9 CM<br/>Ø 2 IN<sup>1/16</sup> X H 8 IN<sup>5/8</sup></p> | <p>184563<br/><b>VERRE À VIN BLANC</b><br/>WHITE WINE GLASS<br/>COPA DE VINO BLANCO<br/>28 CL - 9 OZ<sup>7/16</sup><br/>Ø 7,3 X H 21,2 CM<br/>Ø 2 IN<sup>7/8</sup> X H 8 IN<sup>3/8</sup></p> | <p>184562<br/><b>VERRE À VIN ROUGE</b><br/>RED WINE GLASS<br/>COPA DE VINO TINTO<br/>37 CL - 12 OZ<sup>1/2</sup><br/>Ø 7,7 X H 21,4 CM<br/>Ø 3 IN<sup>1/16</sup> X H 8 IN<sup>7/16</sup></p> | <p>184561<br/><b>VERRE À EAU</b><br/>WATER GLASS<br/>COPA DE AGUA<br/>49,5 CL - 16 OZ<sup>3/4</sup><br/>Ø 8,6 X H 22,7 CM<br/>Ø 3 IN<sup>3/8</sup> X H 8 IN<sup>15/16</sup></p> | <p>184564<br/><b>VERRE À BORDEAUX</b><br/>BORDEAUX GLASS<br/>COPA DE CAVA<br/>65 CL - 22 OZ<br/>Ø 9,4 X H 23,9 CM<br/>Ø 3 IN<sup>17/16</sup> X H 9 IN<sup>7/16</sup></p> | <p>184565<br/><b>VERRE À BOURGOGNE</b><br/>BURGUNDY GLASS<br/>COPA BOURGOGNE<br/>75 CL - 25 OZ<sup>3/8</sup><br/>Ø 10,7 X H 22,5 CM<br/>Ø 4 IN<sup>1/16</sup> X H 8 IN<sup>7/8</sup></p> |
|--|---|--|---|--|--|







184580  
**FLÛTE À CHAMPAGNE**  
CHAMPAGNE FLUTE  
FLAUTA CHAMPÁN  
21 CL - 7 OZ<sup>1/8</sup>  
Ø 7 X H 21 CM  
Ø 2 IN<sup>3/4</sup> X H 8 IN<sup>1/4</sup>

184578  
**VERRE À VIN**  
WINE GLASS  
COPA DE VINO  
20 CL - 6 OZ<sup>3/4</sup>  
Ø 7 X H 17,4 CM  
Ø 2 IN<sup>3/4</sup> X H 6 IN<sup>7/8</sup>

184577  
**VERRE À VIN BLANC**  
WHITE WINE GLASS  
COPA DE VINO BLANCO  
25 CL - 8 OZ<sup>7/16</sup>  
Ø 7,5 X H 18,4 CM  
Ø 2 IN<sup>5/16</sup> X H 7 IN<sup>1/4</sup>

184576  
**VERRE À VIN ROUGE**  
RED WINE GLASS  
COPA DE VINO TINTO  
32 CL - 10 OZ<sup>13/16</sup>  
Ø 7,8 X H 19,8 CM  
Ø 3 IN<sup>1/16</sup> X H 7 IN<sup>13/16</sup>

184575  
**VERRE À EAU**  
WATER GLASS  
COPA DE AGUA  
42 CL - 14 OZ<sup>7/16</sup>  
Ø 8,7 X H 20,5 CM  
Ø 3 IN<sup>7/16</sup> X H 8 IN<sup>1/16</sup>

184579  
**VERRE À BOURGOGNE**  
BURGUNDY GLASS  
COPA BOURGOGNE  
58 CL - 19 OZ<sup>5/8</sup>  
Ø 10 X H 20 CM  
Ø 3 IN<sup>15/16</sup> X H 7 IN<sup>7/8</sup>

MONTMARTRE  
JAUGÉ



14 CL - 4 oz<sup>3/4</sup>  
12,5 CL - 4 oz<sup>1/4</sup>

208481  
**VERRE À VIN ROUGE  
AVEC DOUBLE JAUGE**  
RED WINE GLASS WITH 2 GAUGES  
COPA DE VINO TINTO  
CON DOBLE INDICADOR  
32 CL - 10 OZ<sup>13/16</sup>  
Ø 7,8 X H 19,8 CM  
Ø 3 IN<sup>1/16</sup> X H 7 IN<sup>13/16</sup>

HYPNOTIC  
JAUGÉ



213816  
**VERRE À VIN  
AVEC DOUBLE JAUGE**  
RED WINE GLASS WITH 2 GAUGES  
COPA DE VINO TINTO  
CON DOBLE INDICADOR  
36,5 CL - 13 OZ  
Ø 8,2 X H 22 CM  
Ø 3 IN<sup>1/4</sup> X H 8 IN<sup>17/16</sup>



**AVEC DOUBLE JAUGE**  
WITH 2 GAUGE  
CON DOBLE INDICADOR  
14 CL - 4 oz<sup>3/4</sup>  
12,5 CL - 4 oz<sup>1/4</sup>



@Sébastien D'Halloy  
Le breuvage alcoolisé est dangereux pour la santé.  
Eligirnos prometer responsable drinking and discourages alcohol misuse.  
El beber de alcohol es peligroso para la salud.





**NEW**  
236288  
**CARAFE**  
PITCHER  
BOTELLA  
75 CL - 25 OZ<sup>3/4</sup>  
Ø 9,1 X H 24 CM  
Ø 3 IN<sup>9/16</sup> X H 4 IN<sup>3/8</sup>



**NEW**  
236287  
**VERRE À PIED**  
STEMMED GLASS  
COPA  
26 CL - 8 OZ<sup>3/4</sup>  
Ø 7,9 X H 11,1 CM  
Ø 3 IN<sup>1/8</sup> X H 4 IN<sup>3/8</sup>



**NEW**  
236289  
**GOBELET**  
TUMBLER  
VASO  
26 CL - 8 OZ<sup>3/4</sup>  
Ø 7,1 X H 9,1 CM  
Ø 2 IN<sup>3/16</sup> X H 3 IN<sup>9/16</sup>



**VERRES EMPILABLES**  
STACKABLE GLASSES  
VASOS APILABLES



234148  
**CARAFE**  
PITCHER  
BOTELLA  
75 CL - 25 OZ<sup>3/4</sup>  
Ø 9,1 X H 24 CM  
Ø 3 IN<sup>9/16</sup> X H 4 IN<sup>3/8</sup>



234149  
**VERRE À PIED**  
STEMMED GLASS  
COPA  
26 CL - 8 OZ<sup>3/4</sup>  
Ø 7,9 X H 11,1 CM  
Ø 3 IN<sup>1/8</sup> X H 4 IN<sup>3/8</sup>



234150  
**GOBELET**  
TUMBLER  
VASO  
26 CL - 8 OZ<sup>3/4</sup>  
Ø 7,1 X H 9,1 CM  
Ø 2 IN<sup>3/16</sup> X H 3 IN<sup>9/16</sup>



234151  
**VERRE À TAPAS**  
TAPAS GLASS  
VASO DE TAPAS  
17 CL - 5 OZ<sup>1/4</sup>  
Ø 7,9 X H 6,3 CM  
Ø 3 IN<sup>1/8</sup> X H 2 IN<sup>1/2</sup>



@Patrick ROUGEREAU  
L'alcool est dangereux pour la santé  
Le verre à pied est un produit de la collection  
Et boire de l'alcool est dangereux pour la santé



# CARAFES DÉCANTEURS



169728  
**DECANTEUR MILLÉSIME**  
DECANTER  
DECANTADOR  
1,35 L - 45 OZ<sup>3/8</sup>  
Ø 20,5 X H 23,5 CM  
Ø 8 IN<sup>1/8</sup> X H 9 IN<sup>1/4</sup>



188969  
**DÉCANTEUR VINDÉMIA**  
DECANTER  
DECANTADOR  
1,35 L - 45 OZ<sup>3/8</sup>  
Ø 23 X H 24 CM  
Ø 9 IN<sup>1/8</sup> X H 9 IN<sup>7/16</sup>



210904  
**DÉCANTEUR NECTAR**  
DECANTER  
DECANTADOR  
1 L - 33 OZ<sup>3/16</sup>  
Ø 13,5 X H 24,5 CM  
Ø 5 IN<sup>5/16</sup> X H 9 IN<sup>5/8</sup>



199027  
**CARAFE À WHISKY ANYTIME**  
WHISKY CARAFE  
JARRA DE WHISKY  
1,2 L - 40 OZ<sup>3/16</sup>  
Ø 9,5 X H 26 CM  
Ø 3 IN<sup>3/4</sup> X H 10 IN<sup>1/4</sup>



**NEW**  
236752  
**CARAFE HÉRITAGE**  
CARAFE  
BOTELLA  
1,1 L - 37 OZ<sup>3/16</sup>  
Ø 5,2 X H 25,3 CM  
Ø 2 IN<sup>1/16</sup> X H 9 IN<sup>15/16</sup>



202639  
**CARAFE À JUS DE FRUITS EVENTO**  
JUICE/BEVERAGE CARAFE  
BOTELLA PARA ZUMOS  
1,2 L - 40 OZ<sup>3/16</sup>  
Ø 10,5 X H 27,5 CM  
Ø 4 IN<sup>1/8</sup> X H 10 IN<sup>15/16</sup>



**NEW**  
236288  
**CARAFE EMPILEO**  
PITCHER  
BOTELLA  
75 CL - 25 OZ<sup>3/8</sup>  
Ø 9,1 X H 24 CM  
Ø 3 IN<sup>9/16</sup> X H 4 IN<sup>3/8</sup>



234148  
**CARAFE EMPILEO**  
PITCHER  
BOTELLA  
75 CL - 25 OZ<sup>3/8</sup>  
Ø 9,1 X H 24 CM  
Ø 3 IN<sup>9/16</sup> X H 4 IN<sup>3/8</sup>

202855  
**BOUCHON DE CARAFE SILICONE EVENTO**  
SILICONE STOPPER  
FOR CARAFE  
TAPÓN PARA BOTELLA  
SILICONA  
Ø 6,5 CM - 2 IN<sup>9/16</sup>



Uso de alcohol en dopereux pour la santé.  
Degree no promote responsible drinking and discourages alcohol misuse.  
El abuso de alcohol es peligroso para la salud.



CHAMPAGNE - CHAMPÁN

BIÈRE - BEER - CERVEZA



184567  
**FLÛTE À CHAMPAGNE**  
CHAMPAGNE FLUTE  
FLAUTA CHAMPÁN  
15 CL - 5 OZ<sup>1/16</sup>  
Ø 6,3 X H 19,3 CM  
Ø 2 IN<sup>1/2</sup> X H 7 IN<sup>5/8</sup>



184597  
**VERRE À CHAMPAGNE**  
CHAMPAGNE GLASS  
FLAUTA CHAMPÁN  
21 CL - 7 OZ<sup>1/8</sup>  
Ø 6,8 X H 20,5 CM  
Ø 2 IN<sup>1/8</sup> X H 8 IN<sup>1/16</sup>



210281  
**COUPE À CHAMPAGNE**  
CHAMPAGNE GLASS  
COPA CHAMPÁN  
23 CL - 7 OZ<sup>3/4</sup>  
Ø 9,5 X H 14,7 CM  
Ø 3 IN<sup>3/4</sup> X H 5 IN<sup>13/16</sup>



184569  
**VERRE À BIÈRE**  
BEER GLASS  
VASO CERVEZA  
39 CL - 13 OZ<sup>3/16</sup>  
Ø 7,3 X H 17,7 CM  
Ø 2 IN<sup>7/8</sup> X H 6 IN<sup>15/16</sup>

COCKTAILS - COCTELES



195628  
**VERRE À MARTINI**  
MARTINI GLASS  
COPA DE MARTINI  
25 CL - 8 OZ<sup>1/16</sup>  
Ø 10,6 X H 16,8 CM  
Ø 4 IN<sup>3/16</sup> X H 6 IN<sup>5/8</sup>



209814  
**VERRE À MARGARITA**  
MARGARITA GLASS  
COPA DE MARGARITA  
34 CL - 11 OZ<sup>1/2</sup>  
Ø 11,1 X H 17,2 CM  
Ø 4 IN<sup>3/8</sup> X H 6 IN<sup>1/4</sup>



209815  
**VERRE À COCKTAIL**  
COCKTAIL GLASS  
COPA COCKTAIL  
48 CL - 16 OZ<sup>1/4</sup>  
Ø 8 X H 20,9 CM  
Ø 3 IN<sup>1/8</sup> X H 8 IN<sup>1/4</sup>

DIGESTIF - LIQUEUR WINE - DIGESTIVOS

VERRINES - APPETIZER GLASSES - VASITOS



184570  
**VERRE À COGNAC**  
COGNAC GLASS  
VASO COÑAC  
61 CL - 20 OZ<sup>5/8</sup>  
Ø 10,4 X H 15,5 CM  
Ø 4 IN<sup>1/8</sup> X H 6 IN<sup>1/8</sup>



190700  
**VERRE À PORTO/SHERRY**  
CHERRY GLASS  
COPA JEREZ/OPORTO  
10,4 CL - 3 OZ<sup>1/2</sup>  
Ø 5,6 X H 16,9 CM  
Ø 2 IN<sup>3/16</sup> X H 6 IN<sup>5/8</sup>



209813  
**VERRE À SHOOTER**  
SHOT GLASS  
COPA SHOOTER  
4,5 CL - 1 OZ<sup>1/2</sup>  
Ø 4,6 X H 8 CM  
Ø 1 IN<sup>3/16</sup> X H 3 IN<sup>1/8</sup>



181874  
**VERRINE RONDO**  
APPETIZER GLASS  
VASITO  
13 CL - 4 OZ<sup>1/8</sup>  
Ø 5,5 X H 6 CM  
Ø 2 IN<sup>3/16</sup> X H 2 IN<sup>3/8</sup>



109439  
**COUPELLE BRAZIL**  
APPETIZER GLASS  
VASO  
30 CL - 10 OZ<sup>1/8</sup>  
Ø 13,2 X H 8,7 CM  
Ø 5 IN<sup>3/16</sup> X H 3 IN<sup>3/16</sup>



210811  
**OSLO BOL SABLÉ**  
FROSTED BOWL  
COPA/VASITO MATE  
30 CL - 10 OZ<sup>1/8</sup>



@Patrick ROUGEREAU  
L'abus d'alcool est dangereux pour la santé.  
Il est recommandé de ne pas conduire après avoir bu.  
Elabrado de alcohol es peligroso para la salud.





184555  
**GOBELET HAUT**  
HIGH TUMBLER  
VASO ALTO  
36 CL - 12 OZ<sup>3/16</sup>  
Ø 6,8 X H 14,2 CM  
Ø 2 IN<sup>11/16</sup> X H 5 IN<sup>9/16</sup>



184554  
**GOBELET BAS**  
LOW TUMBLER  
VASO BAJO  
33 CL - 11 OZ<sup>3/16</sup>  
Ø 8 X H 10,2 CM  
Ø 3 IN<sup>1/8</sup> X H 4 IN



184553  
**GOBELET BAS**  
LOW TUMBLER  
VASO BAJO  
23 CL - 7 OZ<sup>3/4</sup>  
Ø 7,6 X H 9,2 CM  
Ø 3 IN X H 3 IN<sup>5/8</sup>



184552  
**GOBELET BAS/VERRINE**  
LOW TUMBLER/APPETIZER GLASS  
VASO BAJO/VASITOS  
15 CL - 5 OZ<sup>1/16</sup>  
Ø 6,4 X H 8 CM  
Ø 2 IN<sup>1/2</sup> X H 3 IN<sup>1/8</sup>



184601  
**GOBELET HAUT**  
HIGH TUMBLER  
VASO ALTO  
39 CL - 13 OZ<sup>3/16</sup>  
Ø 6,6 X H 14,5 CM  
Ø 2 IN<sup>5/8</sup> X H 5 IN<sup>1/16</sup>



184600  
**GOBELET BAS**  
LOW TUMBLER  
VASO BAJO  
35 CL - 11 OZ<sup>3/16</sup>  
Ø 7,9 X H 9,1 CM  
Ø 3 IN<sup>1/8</sup> X H 3 IN<sup>9/16</sup>



184598  
**GOBELET BAS/VERRINE**  
LOW TUMBLER/APPETIZER GLASS  
VASO BAJO/VASITOS  
19 CL - 6 OZ<sup>7/16</sup>  
Ø 6,7 X H 8,1 CM  
Ø 2 IN<sup>5/8</sup> X H 3 IN<sup>3/16</sup>



184589  
**GOBELET HAUT**  
HIGH TUMBLER  
VASO ALTO  
35 CL - 11 OZ<sup>3/16</sup>  
Ø 6,5 X H 14,4 CM  
Ø 2 IN<sup>11/16</sup> X H 5 IN<sup>11/16</sup>



184588  
**GOBELET HAUT**  
HIGH TUMBLER  
VASO ALTO  
29 CL - 9 OZ<sup>3/16</sup>  
Ø 7 X H 10,7 CM  
Ø 2 IN<sup>3/4</sup> X H 4 IN<sup>3/16</sup>



189774  
**GOBELET BAS**  
LOW TUMBLER  
VASO BAJO  
42 CL - 14 OZ<sup>3/16</sup>  
Ø 8,5 X H 10,6 CM  
Ø 3 IN<sup>3/8</sup> X H 4 IN<sup>3/16</sup>



184586  
**GOBELET BAS**  
LOW TUMBLER  
VASO BAJO  
32 CL - 10 OZ<sup>3/16</sup>  
Ø 8 X H 9,4 CM  
Ø 3 IN<sup>1/8</sup> X H 3 IN<sup>11/16</sup>



©Patrick ROUGEREAU  
L'abus d'alcool est dangereux pour la santé.  
Il est déconseillé de consommer de l'alcool pendant  
la conduite d'un véhicule et de boire pendant  
le travail. Évitez de boire pendant la grossesse.



VERRES SOUFLÉS BOUCHE TEINTÉS DANS LA MASSE  
HAND-BLOWN INTEGRALLY DYED GLASSES  
VASOS SOPLADOS A BOCA, PINTADOS EN MASA



169851  
**GOBELET HAUT  
TRANSPARENT**  
TRANSPARENT HIGH TUMBLER  
VASO ALTO TRANSPARENT  
57 CL - 19 OZ<sup>1/4</sup>  
Ø 6,7 X H 11,5 CM  
Ø 2 IN<sup>3/8</sup> X H 4 IN<sup>1/2</sup>

169852  
**GOBELET BAS  
TRANSPARENT**  
TRANSPARENT LOW TUMBLER  
VASO BAJO TRANSPARENT  
43 CL - 14 OZ<sup>3/16</sup>  
Ø 6,1 X H 10 CM  
Ø 2 IN<sup>3/8</sup> X H 3 IN<sup>5/16</sup>

169856  
**GOBELET BAS  
GRIS**  
GREY LOW TUMBLER  
VASO BAJO GRIS  
43 CL - 14 OZ<sup>3/16</sup>  
Ø 6,1 X H 10 CM  
Ø 2 IN<sup>3/8</sup> X H 3 IN<sup>5/16</sup>



VERRES SOUFLÉS BOUCHE TEINTÉS DANS LA MASSE  
HAND-BLOWN INTEGRALLY DYED GLASSES  
VASOS SOPLADOS A BOCA, PINTADOS EN MASA



234489  
**GOBELET  
TRANSPARENT**  
TRANSPARENT TUMBLER  
VASO TRANSPARENT  
40 CL - 13 OZ<sup>1/2</sup>  
Ø 8 X H 12,1 CM  
Ø 3 IN<sup>1/8</sup> X H 4 IN<sup>3/4</sup>

206936  
**GOBELET  
TRANSPARENT**  
TRANSPARENT TUMBLER  
VASO TRANSPARENT  
29 CL - 9 OZ<sup>13/16</sup>  
Ø 7,2 X H 9,5 CM  
Ø 2 IN<sup>13/16</sup> X H 3 IN<sup>3/4</sup>

234491  
**GOBELET  
GRIS**  
GREY TUMBLER  
VASO GRIS  
40 CL - 13 OZ<sup>1/2</sup>  
Ø 8 X H 12,1 CM  
Ø 3 IN<sup>1/8</sup> X H 4 IN<sup>3/4</sup>

225517  
**GOBELET  
GRIS**  
GREY TUMBLER  
VASO GRIS  
29 CL - 9 OZ<sup>13/16</sup>  
Ø 7,2 X H 9,5 CM  
Ø 2 IN<sup>13/16</sup> X H 3 IN<sup>3/4</sup>

234490  
**GOBELET  
BLEU NUIT**  
BLUE NIGHT TUMBLER  
VASO AZUL  
40 CL - 13 OZ<sup>1/2</sup>  
Ø 8 X H 12,1 CM  
Ø 3 IN<sup>1/8</sup> X H 4 IN<sup>3/4</sup>

199461  
**GOBELET  
BLEU NUIT**  
BLUE NIGHT TUMBLER  
VASO AZUL  
29 CL - 9 OZ<sup>13/16</sup>  
Ø 7,2 X H 9,5 CM  
Ø 2 IN<sup>13/16</sup> X H 3 IN<sup>3/4</sup>



180939  
**GOBELET  
BLANC**  
WHITE TUMBLER  
VASO BLANCO  
29 CL - 9 OZ<sup>13/16</sup>  
Ø 7,2 X H 9,5 CM  
Ø 2 IN<sup>13/16</sup> X H 3 IN<sup>3/4</sup>

225516  
**GOBELET  
ROUGE**  
RED TUMBLER  
VASO ROJO  
29 CL - 9 OZ<sup>13/16</sup>  
Ø 7,2 X H 9,5 CM  
Ø 2 IN<sup>13/16</sup> X H 3 IN<sup>3/4</sup>

180936  
**GOBELET  
NOIR**  
BLACK TUMBLER  
VASO NEGRO  
29 CL - 9 OZ<sup>13/16</sup>  
Ø 7,2 X H 9,5 CM  
Ø 2 IN<sup>13/16</sup> X H 3 IN<sup>3/4</sup>

199462  
**GOBELET  
VERT POMME**  
APPLE GREEN TUMBLER  
VASO VERDE  
29 CL - 9 OZ<sup>13/16</sup>  
Ø 7,2 X H 9,5 CM  
Ø 2 IN<sup>13/16</sup> X H 3 IN<sup>3/4</sup>

174510  
**GOBELET  
CASSIS**  
PURPLE TUMBLER  
VASO PÚRPURA  
29 CL - 9 OZ<sup>13/16</sup>  
Ø 7,2 X H 9,5 CM  
Ø 2 IN<sup>13/16</sup> X H 3 IN<sup>3/4</sup>



©Sébastien D'Halloy  
L'abus d'alcool est dangereux pour la santé.  
Il est recommandé de ne pas boire et conduire.  
El abuso de alcohol es peligroso para la salud.

Finedining

DOLCE



Alldaydining

ALLEGRO





VERRES SOUFLÉS BOUCHE TEINTÉS DANS LA MASSE  
HAND-BLOWN INTEGRALLY DYED GLASSES  
VASOS SOPLADOS A BOCA, PINTADOS EN MASA



**NEW**  
236340  
**VERRE À PIED**  
STEMMED GLASS  
VASO BAJO  
27 CL - 9 OZ<sup>1/8</sup>  
Ø 7,2 X H 11,5 CM  
Ø 2 IN<sup>13/16</sup> X H 4 IN<sup>1/2</sup>



**NEW**  
236338  
**GOBELET BAS**  
LOW TUMBLER  
VASO BAJO  
18 CL - 7 OZ<sup>1/16</sup>  
Ø 7,2 X H 6,5 CM  
Ø 2 IN<sup>13/16</sup> X H 2 IN<sup>9/16</sup>



**NEW**  
236339  
**GOBELET HAUT**  
HIGH TUMBLER  
VASO ALTO  
45 CL - 15 OZ<sup>3/16</sup>  
Ø 7,2 X H 14 CM  
Ø 2 IN<sup>13/16</sup> X H 5 IN<sup>1/2</sup>



Finedining

NEW ROC



VERRES SOUFLÉS BOUCHE TEINTÉS DANS LA MASSE  
HAND-BLOWN INTEGRALLY DYED GLASSES  
VASOS SOPLADOS A BOCA, PINTADOS EN MASA



**NEW**  
236988  
**GOBELET INCOLORE**  
TRANSPARENT TUMBLER  
VASO TRANSPARENT  
30 CL - 10 OZ<sup>1/8</sup>  
Ø 8,8 X H 8,8 CM  
Ø 3 IN<sup>7/16</sup> X H 3 IN<sup>7/16</sup>



235133  
**GOBELET ARGILE VERTE**  
GREEN CLAY TUMBLER  
VASO ARCILLA VERDE  
30 CL - 10 OZ<sup>1/8</sup>  
Ø 8,8 X H 8,8 CM  
Ø 3 IN<sup>7/16</sup> X H 3 IN<sup>7/16</sup>



230891  
**GOBELET GRIS**  
GREY TUMBLER  
VASO GRIS  
30 CL - 10 OZ<sup>1/8</sup>  
Ø 8,8 X H 8,8 CM  
Ø 3 IN<sup>7/16</sup> X H 3 IN<sup>7/16</sup>



230890  
**GOBELET SABLE ROSE**  
PINK TUMBLER  
VASO ROSE  
30 CL - 10 OZ<sup>1/8</sup>  
Ø 8,8 X H 8,8 CM  
Ø 3 IN<sup>7/16</sup> X H 3 IN<sup>7/16</sup>



230889  
**GOBELET BLEU DE ROCHE**  
BLUE TUMBLER  
VASO AZUL  
30 CL - 10 OZ<sup>1/8</sup>  
Ø 8,8 X H 8,8 CM  
Ø 3 IN<sup>7/16</sup> X H 3 IN<sup>7/16</sup>



**VERRES EMPILABLES**  
STACKABLE GLASSES  
VASOS APILABLES



Alldaydining

BILBAO



VERRES SOUFLÉS BOUCHE TEINTÉS DANS LA MASSE  
HAND-BLOWN INTEGRALLY DYED GLASSES  
VASOS SOPLADOS A BOCA, PINTADOS EN MASA



171631  
**GOBELET GRIS**  
GREY TUMBLER  
VASO GRIS  
34 CL - 11 OZ<sup>1/2</sup>  
Ø 8,5 X H 10 CM  
Ø 3 IN<sup>3/8</sup> X H 3 IN<sup>15/16</sup>



171632  
**GOBELET VERT**  
GREEN TUMBLER  
VASO VERDE  
34 CL - 11 OZ<sup>1/2</sup>  
Ø 8,5 X H 10 CM  
Ø 3 IN<sup>3/8</sup> X H 3 IN<sup>15/16</sup>



171633  
**GOBELET VIOLET**  
PURPLE TUMBLER  
VASO VIOLETA  
34 CL - 11 OZ<sup>1/2</sup>  
Ø 8,5 X H 10 CM  
Ø 3 IN<sup>3/8</sup> X H 3 IN<sup>15/16</sup>



171630  
**GOBELET ROUGE**  
RED TUMBLER  
VASO ROJO  
34 CL - 11 OZ<sup>1/2</sup>  
Ø 8,5 X H 10 CM  
Ø 3 IN<sup>3/8</sup> X H 3 IN<sup>15/16</sup>



© Patrick ROUGEREAU



Alldaydining

MAMBO



## LE BUFFET EVENTO

**D**u petit-déjeuner au dîner, des buffets sucrés aux buffets salés, la collection **EVENTO** répond à tous les scénarios de réception. Un design **homogène, harmonieux, fonctionnel et modulable**. La **richesse de ses combinaisons** et la **diversité de ses matériaux** (acier, porcelaine, verre, grès, mélamine pierre et bois etc...) **s'adaptent à votre style** et à la **dimension de votre établissement**. La collection **EVENTO** valorise avec une touche de chic la mise en scène de vos buffets, selon le moment de la journée, de la saison...

### KITCHENWARE FOR YOUR BUFFET

From **breakfast to dinner**, from sweet buffets to savoury spreads, the **EVENTO** collection works for all your reception needs. A **unified, harmonious, practical and modular** design. With a **host of combinations** and a **range of materials** to choose from (steel, porcelain, glass, stoneware, melamine, stone and wood...), you can find what **works for your style** and the **size of your space**. The **EVENTO** collection adds a chic touch to your buffet presentations to reflect the time of day or the season.

### CREACIÓN DE UN BUFÉ

La colección **EVENTO** resulta perfecta para cualquier recepción, tanto para bufés dulces como salados, del **desayuno a la cena**. Un diseño **homogéneo, armonioso, funcional y modulable**. La **riqueza de sus combinaciones** y la **diversidad de sus materiales** (acero, porcelana, cristal, gres, melamina de piedra y madera...) **se amoldan a su estilo** y a las **dimensiones de su establecimiento**. La colección **EVENTO** aporta un toque sofisticado para realzar la presentación de sus bufés según el momento del día, de la temporada.

**EVENTO**  
PLATEAUX POUR MODULES FROIDS P.226  
PLATTERS FOR REFRIGERATED UNITS - BANDEJAS PARA LOS MODULOS REFRIGERADOS  
PLATEAUX RONDS P.234  
ROUND TRAY - BANDEJA REDONDA  
PLATEAUX GN 1/1 - 2/3 - 1/2 - 1/3 - MELAMINE PIERRE - MELAMINE BOIS P.226  
TRAY - BANDEJA - STONE MELAMINE - WOOD MELAMINE  
MELAMINA PIEDRA - MELAMINA MADERA





## CHAFING DISHES\*

LE CHAFING DISH, PAR SON **DESIGN CONTEMPORAIN** ALLIANT ACIER, PORCELAIN ET VERRE OFFRE À VOTRE BUFFET UNE **PRÉSENTATION SOIGNÉE ET RAFFINÉE**.

THE CHAFING DISH, WITH ITS **CONTEMPORARY DESIGN** THAT COMBINES STEEL, PORCELAIN AND GLASS, BRINGS A **SMART AND SOPHISTICATED TOUCH** TO YOUR BUFFET DISPLAY.

EL CHAFING DISH, POR SU **DISEÑO CONTEMPORÁNEO** QUE COMBINA ACERO, PORCELANA Y CRISTAL OFRECE A SU BUFFET UNA PRESENTACIÓN **CUIDADA Y REFINADA**.



**Couvercle en verre transparent** pour percevoir le contenu et rendre le buffet plus gourmand

**Clear glass cover** allows contents to be viewed instantly and makes the buffet more enticing

**Cubierta de vidrio transparente** permite que el contenido pueda ser visto instantáneamente y hace que el buffet más atractivo

**Charnière avec vérin et amortisseur** pour un réel confort d'utilisation et une fermeture en douceur

**The hydraulic buffering hinge** offers user comfort and convenience with its soft closure mechanism

**La bisagra con amortiguación hidráulica** ofrece al usuario comodidad y conveniencia con su mecanismo de cierre suave



**Encoches pour les couverts de service**

**The notch for the serving cutlery**

**El agua condensada se recoge mediante un sistema de la ranura para las piezas de servicio**

**Compatible plaque induction, avec résistance électrique ou porte-brûleur avec gel combustible**

**Compatible with induction, electrical and/or «sterno» fuel heating system**

**Compatible con induccion, eléctrico o sistema de color externo**

**Système de récupération d'eau de condensation**

**Condensation water collection system in the porcelain insert**

**El agua condensada se recoge mediante un sistema de recolección en la base de porcelana**

\*CERTAINES PIÈCES SONT DISPONIBLES EN PIÈCES DÉTACHÉES  
SOME ITEMS ARE AVAILABLE INDIVIDUALLY  
ALGUNOS DE ESTOS ARTICULOS ESTÁN DISPONIBLES COMO PIEZAS SEPARADAS





236195  
**CHAFING DISH SANS BAC FINITION MIROIR**  
CHAFING DISH WITHOUT INSERT MIRROR FINISH  
CHAFING DISH SIN BANDEJA ACABADO BRILLO  
Ø 35,5 CM - P 41 CM - H 15 CM  
Ø 14 IN - D 16 IN<sup>1/8</sup> - H 5 IN<sup>7/8</sup>

Acier inoxydable, couvercle avec gouttière, verre trempé  
Stainless steel, lid with groove, tempered glass  
Acero inoxidable, tapa con canalón vidrio templado



236194  
**CHAFING DISH SANS BAC FINITION BROSSÉE**  
CHAFING DISH WITHOUT INSERT BRUSHED FINISH  
CHAFING DISH SIN BANDEJA ACABADO SATINADO  
Ø 35,5 CM - P 41 CM - H 15 CM  
Ø 14 IN - D 16 IN<sup>1/8</sup> - H 5 IN<sup>7/8</sup>

Acier inoxydable, couvercle avec gouttière, verre trempé  
Stainless steel, lid with groove, tempered glass  
Acero inoxidable, tapa con canalón vidrio templado



203470  
**COUVERCLE AVEC GOUTTIÈRE ACIER, VERRE TREMPÉ**  
LID WITH STAINLESS STEEL GUTTER, TEMPERED GLASS  
TAPA EN ACERO INOX Y VIDRIO TEMPLADO  
Ø 33 CM - 13 IN



216142  
**BAC ACIER POUR CHAFING DISH**  
CHAFING STAINLESS STEEL INSERT  
BANDEJA DE ACERO INOXIDABLE PARA CHAFING  
Ø 35,6 X H 7 CM - CONTENANCE 3L  
Ø 14 X 2 IN<sup>3/4</sup> - CAPACITY 100 OZ



215721  
**BAC PORCELAINE POUR CHAFING DISH**  
CHAFING PORCELAIN INSERT  
BANDEJA DE PORCELANA PARA CHAFING  
Ø 35,6 X H 7 CM - CONTENANCE 3L  
Ø 14 X 2 IN<sup>3/4</sup> - CAPACITY 100 OZ



202635  
**1/2 BAC PORCELAINE POUR CHAFING DISH**  
1/2 CHAFING PORCELAIN INSERT  
1/2 BANDEJA DE PORCELANA PARA CHAFING  
L 29 X L15 X H 4,5 CM - CONTENANCE 1L  
11 IN<sup>7/8</sup> X 5 IN<sup>7/8</sup> X 1 IN<sup>3/4</sup> - CAPACITY 33 OZ<sup>13/16</sup>

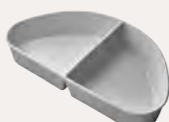

236684 **NEW**  
**1/2 BAC PORCELAINE POUR CHAFING DISH AVEC SEPARATEUR**  
1/2 PORCELAIN INSERT FOR CHAFING DISH  
1/2 BANDEJA DE PORCELANA CON DELIMITADOR PARA CHAFING  
L 29,3 CM X H 4,6 CM  
L 11 IN<sup>3/16</sup> X H 1 IN<sup>13/16</sup>

**SUPPORT CHAFING**  
**ACIER INOXYDABLE POUR RÉSISTANCE ÉLECTRIQUE OU PORTE-BRÛLEUR AVEC GEL COMBUSTIBLE**  
CHAFING STAND STAINLESS STEEL FOR ELECTRICAL AND/OR STERNO HEATING PURPOSES  
SOPORTE PARA CHAFING DISH ACERO INOXIDABLE PARA RESISTENCIA ELÉCTRICA O CALENTADOR EXTERNO

Ø 35 CM - P 40 CM - H 12,5 CM  
Ø 13 IN<sup>3/4</sup> X D 15 IN<sup>3/4</sup> X H 4 IN<sup>5/16</sup>



203005  
**FINITION MIROIR**  
MIRROR FINISH  
ACABADO BRILLO



202859  
**FINITION BROSSÉE**  
BRUSHED FINISH  
ACABADO SATINADO



**RÉSISTANCE AVEC RÉGULATEUR DE TEMPÉRATURE**  
HEATING ELEMENT - HEAT ADJUSTABLE  
RESISTENCIA CON REGULADOR DE TEMPERA  
202860 - 220 /240 V /200 W  
203468 - 110 /120 V  
20 X 20 CM - 7 IN<sup>7/8</sup> X 7 IN<sup>7/8</sup>



202861  
**PORTE-BRÛLEUR POUR GEL COMBUSTIBLE ACIER**  
BURNER HOLDER STEEL  
QUEMADOR ACERO INOXIDABLE  
Ø 9 CM - H 6 CM  
Ø 3 IN<sup>3/16</sup> X 2 IN<sup>3/8</sup>

© Patrick ROUGEREAU



## MODULES FROIDS\*

REFRIGERATED UNITS - MODULOS REFRIGERADOS

LE MODULE RÉFRIGÉRÉ REÇOIT UNE **LARGE GAMME DE CONTENANTS**, PLATEAUX ET ACCESSOIRES **MULTI-MATÉRIAUX** AU FORMAT GN EN PORCELAIN, VERRE, ACIER, ACRYLIQUE, MÉLAMINE PIERRE ET MÉLAMINE BOIS. **ILS PERMETTENT UNE INFINITÉ DE COMBINAISONS.**

THE REFRIGERATED UNIT WILL HOLD A **WIDE RANGE OF PLATTERS AND MULTI-MATERIAL** ACCESSORIES IN INDUSTRY STANDARD FORMAT IN PORCELAIN, GLASS, STEEL, ACRYLIC, STONE AND WOOD MELAMINE **ALLOWING ENDLESS COMBINATIONS.**

EL MÓDULO REFRIGERADO PRESENTA **UNA AMPLIA VARIEDAD DE BANDEJAS Y ACCESORIOS DE MÚLTIPLES MATERIALES** EN FORMATO GN EN PORCELANA, VIDRIO, ACERO, ACRÍLICO, MELAMINA DE PIEDRA Y MELAMINIA MADERA QUE **PERMITEN UN NÚMERO INFINITO DE COMBINACIONES.**



**202864**  
**FINITION MIROIR**  
STAINLESS STEEL MIRROR  
ACABADO BRILLO

**202865**  
**FINITION BROSSÉE**  
STAINLESS STEEL BRUSHED  
ACABADO SATINADO

**202869**  
**NOIR MÉTALLISÉ**  
METALLIC BLACK  
ACABADO NEGRO METALICO

**202871**  
**MODULE ACIER GN 1/2<sup>(1)</sup>**  
**+ BAC PLASTIQUE**  
REFRIGERATED SET  
+ PLASTIC TRAY GN 1/2  
MODULO DE ACERO  
+ BANDEJA GN 1/2  
L 56,5 CM - P 36 CM - H 9,5 CM  
22 IN<sup>1/4</sup> - D 14 IN<sup>3/16</sup> X 3 IN<sup>3/4</sup>

**235356**  
**FINITION MIROIR**  
STAINLESS STEEL MIRROR  
ACABADO BRILLO

**235361**  
**FINITION BROSSÉE**  
STAINLESS STEEL BRUSHED  
ACABADO SATINADO

**235362**  
**NOIR MÉTALLISÉ**  
METALLIC BLACK  
ACABADO NEGRO METALICO

(1) GARANTIE LAVE-VAISSELLE  
DISH WASHER SAFE  
GARANTIA LAVA-VAJILLAS

\*CERTAINES PIÈCES SONT DISPONIBLES EN PIÈCES DÉTACHÉES  
SOME ITEMS ARE AVAILABLE INDIVIDUALLY  
ALGUNOS DE ESTOS ARTICULOS ESTÁN DISPONIBLES COMO  
PIEZAS SEPARADAS

56,5 CM - 22 IN<sup>1/4</sup>

36 CM - 14 IN<sup>13/16</sup>



L 56,5 CM X P 36 CM X H 9,5 CM  
22 IN<sup>1/4</sup> X D 14 IN<sup>3/16</sup> X 3 IN<sup>3/4</sup>



**202871**  
**COUVERCLE MODULE**  
**RÉFRIGÉRÉ POIGNÉE INOXYDABLE**  
LID FOR REFRIGERATED SET/  
STAINLESS STEEL HANDLE  
CUBIERTA PARA EL MÓDULO  
REFRIGERADO/ASA ACERO INOXIDABLE  
56 X 35 X 19 CM  
22 IN<sup>1/16</sup> X 13 IN<sup>3/4</sup> X 7 IN<sup>1/2</sup>

**208357**  
**PLAQUE EUTECTIQUE POUR**  
**MODULE FROID GN1/1**  
BLACK COOLING  
EUTECTIQUE BLOCK FOR UNIT GN1/1  
NEGRO ACUMULADOR DE  
REFRIGERACION 1/1  
48 X 28 X 3 CM  
18 IN<sup>7/8</sup> X 11 IN X 1 IN<sup>1/16</sup>

**234568**  
**PLAQUE EUTECTIQUE POUR**  
**MODULE FROID GN 1/2**  
BLACK COOLING  
EUTECTIQUE BLOCK FOR UNIT GN1/2  
NEGRO ACUMULADOR DE  
REFRIGERACION 1/2  
18 X 25 CM  
7 IN<sup>5/16</sup> X 9 IN<sup>13/16</sup>

© Patrick ROUGEREAU

Modules froids

EVENTO



## PLATEAUX POUR MODULES FROIDS

PLATTERS FOR REFRIGERATED UNITS  
BANDEJAS PARA LOS MODULOS REFRIGERADOS

**GN 1/1**  
53,5 X 32,5 CM  
20 IN<sup>7/8</sup> X 12 IN<sup>13/16</sup>

**GN 2/3**  
35,4 X 32,5 CM  
13 IN<sup>15/16</sup> X 12 IN<sup>13/16</sup>

**GN 1/2**  
26,4 X 32,5 CM  
10 IN<sup>3/8</sup> X 12 IN<sup>13/16</sup>

**GN 1/3**  
17,5 X 32,5 CM  
6 IN<sup>7/8</sup> X 12 IN<sup>13/16</sup>

**GN 1/6**  
8,7 X 32,5 CM  
3 IN<sup>7/16</sup> X 12 IN<sup>13/16</sup>

**PLATEAU GRÈS CARBONE<sup>(1)</sup>**  
GRES STONEWARE TRAY  
BANDEJA GRES TONO CARBONO

234550 - GN 2/3  
234555 - GN 1/3

**PLAT À REBORDS GRÈS CARBONE<sup>(1)</sup>**  
GREY STONEWARE EDGE TRAY  
BANDEJA CON BORDES GRES TONO CARBONO

234556 - GN 1/3

**PLATEAU PORCELAINE**  
WHITE ENAMELLED PORCELAIN TRAY  
BANDEJA PORCELANA

202628 - GN 2/3  
202629 - GN 1/2  
202627 - GN 1/3

**PLAT CREUX PORCELAINE**  
WHITE ENAMELLED PORCELAIN  
DEEP DISH  
BANDEJA PORCELANA

202630 - GN 1/3

**PLATEAU MÉLAMINE BOIS<sup>(2)</sup>**  
WOOD MELAMINE TRAY  
BANDEJA MELAMINA MADERA

234546 - GN 1/1  
234548 - GN 2/3  
234551 - GN 1/2  
234553 - GN 1/3

**PLATEAU 3 TROUS MÉLAMINE BOIS<sup>(2)</sup>**  
WOOD MELAMINE TRAY 3 HOLES  
BANDEJA MELAMINA MADERA CON 3 HUELLAS

234557 - GN 1/6

**PLATEAU MÉLAMINE PIERRE<sup>(2)</sup>**  
STONE MELAMINE TRAY  
BANDEJA MELAMINA PIEDRA

234547 - GN 1/1  
234549 - GN 2/3  
234552 - GN 1/2  
234554 - GN 1/3

**PLATEAU 3 TROUS MÉLAMINE PIERRE<sup>(2)</sup>**  
STONE MELAMINE TRAY 3 HOLES  
BANDEJA MELAMINA PIEDRA CON 3 HUELLAS

234558 - GN 1/6

**PLATEAU ACIER 18-10**  
**NEWPORT FINITION MIROIR**  
SERVING TRAY STAINLESS STEEL 18-10  
MIRROR FINISHED  
BANDEJA RECTANGULAR ACERO 18-10  
ACABADO BRILLO

185021 - 238962\* - GN 1/1  
185019 - 238960\* - GN 1/2

**PLATEAU VERRE ÉPAISSEUR 0,6 CM**  
TEMPERED GLASS TRAY THICKNESS 1/4  
BANDEJA CRISTAL GROSOR 0,6 CM

230752 - GN 1/1  
230753 - GN 2/3

**PLATEAU ACRYLIQUE ÉPAISSEUR 1 CM**  
ACRYLIC TRAY THICKNESS 3/8  
BANDEJA ACRÍLICO GROSOR 1 CM

**2 TROUS - 2 HOLES - 2 AGUJEROS**

230756 - GN 1/1

**1 TROU - 1 HOLE - 1 AGUJERO**

230755 - GN 1/2  
Adapté aux bols 22 cm - Adapted for bowls  
8,6 inch - Adaptados a boles de 22 cm

**2 TROUS - 2 HOLES - 2 AGUJEROS**

230757 - GN 1/3  
Adapté aux bols 14 cm - Adapted for bowls  
5,5 inch - Adaptados a boles de 14 cm

\*NOUVEAUX CODES À PARTIR DU 01/04/2020  
NEW CODES VALID FROM 2020/04/01  
NUEVOS CODIGOS A PARTIR DE 01/04/2020

(1) GARANTIE LAVE-VAISSELLE  
DISH WASHER SAFE  
GARANTIA LAVA-VAJILLAS

GARANTIE MICRO-ONDES  
MICROWAVE SAFE  
GARANTIA MICRO-ONDAS

(2) COMPATIBLE LAVE-VAISSELLE  
DISH WASHER SAFE  
GARANTIA LAVA-VAJILLAS

NON COMPATIBLE MICRO-ONDES  
DON'T USE WITH MICRO-WAVE  
NO VA EN EL MICRO-ONDAS

© Patrick ROUGEREAU

Modules froids

EVENTO



**URNES À JUS DE FRUITS\***  
FRUIT JUICE URNS - DISPENSADORES DE ZUMOS

URNE À JUS DE FRUIT DOTÉE D'UN TUBE CENTRAL EN ACIER POUR GLACE PILÉE :  
**PARFAIT MAINTIEN DE LA FRAÎCHEUR**

FRUIT JUICE URN WITH CENTRAL STEEL TUBE TO HOLD CRUSHED ICE,  
**FOR PERFECT FRESHNESS**

DISPENSADOR DE ZUMOS DOTADO CON UN TUBO CENTRAL DE ACERO PARA  
HIELO PICADO **PARA MANTENER LA FRESCURA**

**URNE À JUS DE FRUITS 4L - ACIER 18-10**  
JUICE DISPENSER 135 OZ STAINLESS STEEL  
DISPENSADOR DE ZUMO ACERO

231303 <b>MIROIR</b> MIRROR ACABADO BRILLO	231304 <b>BROSSÉ</b> BRUSHED ACABADO SATINADO
---	--

202855  
**BOUCHON DE CARAFE SILICONE**  
STOPPER FOR CARAFE - SILICONE  
TAPÓN PARA BOTELLA - SILICONA  
Ø 6,5 CM - H 4,2 CM  
Ø 2 1/8" X H 1 1/8"



202639  
**CARAFE À JUS DE FRUIT - 1,2 L**  
**CRISTALLIN SOUFLÉ BOUCHE**  
JUICE/BEVERAGE CARAFE - 40 OZ 9/16  
HAND BLOWN CRYSTALLINE  
BOTELLA PARA ZUMOS  
CRISTAL SOPLADO EN BOCA  
Ø 10,5 CM - H 27,5 CM  
Ø 4 1/8" X H 10 13/16"



**NEW**  
237501  
**RAFRAICHISSEUR DROIT DOUBLE PAROI**  
CURVED DOUBLE WALL WINE COOLER  
ENFRIADOR DE BOTELLA DOBLE PARED  
Ø 13,9 X H 19,8 CM  
Ø 5 1/2" X H 7 13/16"

202632  
**ÉTIQUETTE PORCELAIN**  
**AVEC AIMANT+ SUPPORT ACIER**  
PORCELAIN STICK + STAINLESS STEEL STAND  
WITH MAGNET  
ÉTIQUETA PORCELANA + SOPORTE ACERO  
INOX CON IMÁN  
10 X 5 CM - 3 1/8" X 1 1/8"



\*CERTAINES PIÈCES SONT DISPONIBLES EN PIÈCES DÉTACHÉES  
SOME ITEMS ARE AVAILABLE INDIVIDUALLY  
ALGUNOS DE ESTOS ARTICULOS ESTÁN DISPONIBLES COMO PIEZAS SEPARADAS

20 CM - 7 1/8"

45 CM - 17 1/8"



4L - 135 OZ  
L 20 CM X P 32 CM X H 45 CM  
W 7 1/8" X D 12 1/8" X H 17 1/8"



**BOUCHON VERSEUR EN SILICONE,**  
**POUR UNE MEILLEURE HYGIÈNE**

HYGIENIC SILICONE POURING STOPPER  
TAPÓN DE SILICONA PARA MAYOR HIGIENE  
Y CONTROL DEL VERTIDO

**POSSIBILITÉ D'AIMANTER**  
**L'ÉTIQUETTE PORCELAIN**  
**SUR LE COUVERCLE**

MAGNETIC PORCELAIN  
NAME PLATE ACCESSORY  
FOR LID PLACEMENT

PLACA DE PORCELAINA  
MAGNÉTICA PARA COLOCAR  
LOS NOMBRES



©Patrick ROUGEREAU

Urnes à jus de fruits

EVENTO



**DISTRIBUTEURS À CÉRÉALES\***  
CEREAL DISPENSERS - DISPENSADORES DE CEREALES

DISTRIBUTEUR À CÉRÉALES 1 OU 3 TUBES  
AVEC AILETTES SOUPLES POUR NE PAS CASSER LES CÉRÉALES

CEREAL DISPENSER 1 OR 3 TUBS WITH  
FLEXIBLE SPOUT SO AS NOT TO BREAK THE CEREALS

DISPENSADOR DE CEREALES 1 O 3 TUBOS CON  
PESTAÑAS FLEXIBLES PARA NO ROMPER LOS CEREALES



50 CM - 19 IN<sup>11/16</sup>

231300 - X3  
L 50 CM X P 20 CM X H 55,5 CM  
W 19 IN<sup>11/16</sup> X D 7 IN<sup>7/8</sup> X H 21 IN<sup>7/8</sup>  
CAPACITÉ : 3 X 3,5 L  
CAPACITY : 3 X 1 GAL

202855  
**BOUCHON DE CARAFE SILICONE**  
STOPPER FOR CARAFE - SILICONE  
TAPON PARA BOTELLA - SILICONA  
Ø 6,5 CM - H 4,2 CM  
Ø 2 IN<sup>9/16</sup> X H 1 IN<sup>5/8</sup>



202636  
**CARAFE À LAIT - 1,2 L  
PORCELAINE**  
PORCELAIN MILK JUG - 40 OZ<sup>9/16</sup>  
BOTELLA PARA LECHE  
PORCELANA  
Ø 10,5 CM - H 27,5 CM  
Ø 4 IN<sup>1/8</sup> X H 10 IN<sup>13/16</sup>

\*CERTAINES PIÈCES SONT DISPONIBLES EN PIÈCES DÉTACHÉES  
SOME ITEMS ARE AVAILABLE INDIVIDUALLY  
ALGUNOS DE ESTOS ARTICULOS ESTÁN DISPONIBLES COMO PIEZAS SEPARADAS

19 CM - 7 IN<sup>1/2</sup>



55 CM - 21 IN<sup>7/8</sup>

231299 - X1  
L 19 CM X P 20 CM X H 55,5 CM  
W 7 IN<sup>1/2</sup> X D 7 IN<sup>7/8</sup> X H 21 IN<sup>7/8</sup>  
CAPACITÉ : 3,5 L  
CAPACITY : 1 GAL

154245  
**BOL MODULO BLANC**  
WHITE MODULO BOWL  
BOL MODULO BLANCO  
14 CM - 5 IN<sup>1/2</sup>



202626  
**BOL EMPILABLE**  
PORCELAIN STACKABLE BOWL  
BOWL PORCELANA APILABLE  
14 CM - 5 IN<sup>1/2</sup>



© Patrick ROUGEREAU

Distributeurs à céréales

EVENTO



**SUPPORTS À FIL RECTANGULAIRES**  
RECTANGULAR TRAYS - SOPORTES RECTANGULARES

DES SUPPORTS EN ACIER NOIR MAT DE HAUTEURS DIFFÉRENTES POUR RYTHMER LES PRÉSENTATIONS

BLACK MAT FINISH SUPPORTS OF DIFFERING HEIGHTS CAN BE USED TO CREATE A VARIED PRESENTATION

SOPORTES DE ACERO NEGRO DE DIFERENTES ALTURAS PARA MARCAR EL RITMO DE LAS PRESENTACIONES

230741  
**SUPPORT RECTANGULAIRE NIVEAU 1**  
RECTANGULAR TRAY, LEVEL 1  
SOPORTE RECTANGULAR, NIVEL 1  
L 44 X P 30,8 X H 10,8 CM  
W 17 IN<sup>5/16</sup> X D 12 IN<sup>1/8</sup> X H 4 IN<sup>1/4</sup>



230742  
**SUPPORT RECTANGULAIRE NIVEAU 2**  
RECTANGULAR TRAY, LEVEL 2  
SOPORTE RECTANGULAR, NIVEL 2  
L 42 X P 30,8 X H 29,8 CM  
W 16 IN<sup>5/16</sup> X D 12 IN<sup>1/8</sup> X H 11 IN<sup>3/4</sup>

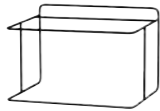

230741 + 230742  
**SUPPORT RECTANGULAIRE NIVEAU 1+2**  
RECTANGULAR TRAY, LEVEL 1+2  
SOPORTE RECTANGULAR, NIVEL 1+2  
L 44 X P 50 X H 29,8 CM  
W 17 IN<sup>5/16</sup> X D 19 IN<sup>11/16</sup> X H 11 IN<sup>3/4</sup>

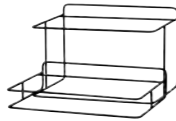

230743  
**SUPPORT RECTANGULAIRE NIVEAU 3**  
RECTANGULAR TRAY, LEVEL 3  
SOPORTE RECTANGULAR, NIVEL 3  
L 40 X P 30,8 X H 48,8 CM  
W 15 IN<sup>3/4</sup> X D 12 IN<sup>1/8</sup> X H 19 IN<sup>3/16</sup>

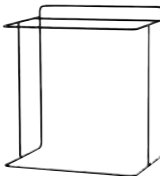

230742 + 230743  
**SUPPORT RECTANGULAIRE NIVEAU 2+3**  
RECTANGULAR TRAY, LEVEL 2+3  
SOPORTE RECTANGULAR, NIVEL 2+3  
L 42 X P 50 X H 48,8 CM  
W 16 IN<sup>5/16</sup> X D 19 IN<sup>11/16</sup> X H 19 IN<sup>3/16</sup>

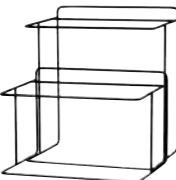

230741 + 230742 + 230743  
**SUPPORT RECTANGULAIRE NIVEAU 1+2+3**  
RECTANGULAR TRAY, LEVEL 1+2+3  
SOPORTE RECTANGULAR, NIVEL 1+2+3  
L 44 X P 68,2 X H 48,8 CM  
W 17 IN<sup>5/16</sup> X D 26 IN<sup>7/8</sup> X H 19 IN<sup>3/16</sup>



230749  
**PANIÈRE RECTANGULAIRE - GN 1/1**  
RECTANGULAR BREAD BASKET  
CESTA BOLLERÍA RECTANGULAR  
54 X 34 X H 7 CM  
21 IN<sup>1/4</sup> X 13 IN<sup>3/8</sup> X 2 IN<sup>3/4</sup>



**PANIÈRE REVERSIBLE POUR UNE PRÉSENTATION DROITE OU INCLINÉE**  
REVERSIBLE BASKET FOR A LEVEL OR TITLED DISPLAY  
PANERA REVERSIBLE PARA UNA PRESENTACION DERECHA O INCLINADA



230744  
**CADRE ACIER POUR SUPPORT RECTANGULAIRE<sup>(1)</sup>**  
STEEL FRAME FOR STAND  
ESTRUCTURA DE ACERO  
L 55,5 X P 35 X H 4,5 CM  
W 21 IN<sup>7/8</sup> X D 13 IN<sup>3/4</sup> X H 1 IN<sup>1/4</sup>

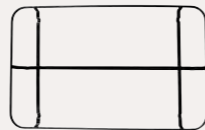

185021 - GN1/1  
**PLATEAU ACIER 18-10 NEWPORT FINITION MIROIR**  
SERVING TRAY STAINLESS STEEL 18-10  
MIRROR FINISHED  
BANDEJA RECTANGULAR ACERO 18-10  
ACABADO BRILLO



230752 - GN1/1  
**PLATEAU VERRE ÉPAISSEUR 0,6 CM**  
TEMPERED GLASS TRAY THICKNESS IN<sup>1/4</sup>  
BANDEJA CRISTAL GROSOR 0,6 CM



234546 - GN1/1  
**PLATEAU MÉLAMINE BOIS<sup>(2)</sup>**  
WOOD MELAMINE TRAY  
BANDEJA MELAMINA MADERA



234547 - GN1/1  
**PLATEAU MÉLAMINE PIERRE<sup>(2)</sup>**  
STONE MELAMINE TRAY  
BANDEJA MELAMINA PIEDRA

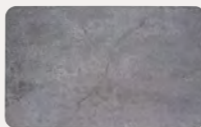

(1) À COMMANDER UNIQUEMENT POUR LES PLATEAUX GN 1/1  
TO ORDER ONLY FOR TRAYS GN 1/1  
SOLO PEDIR PARA LOS BANDEJAS GN1/1

(2) COMPATIBLE LAVE-VAISSELLE NON COMPATIBLE MICRO-ONDES  
DISH WASHER SAFE DON'T USE WITH MICRO-WAVE  
GARANTIA LAVA-VAJILLAS NO VA EN EL MICRO-ONDAS

© Patrick ROUGEREAU



**SUPPORTS À FIL RONDS**  
ROUND TRAYS - RONDOS BANDEJAS

POUR PANIÈRES RONDES, PLATEAUX 32 CM ET SALADIERS  
STANDS FOR ROUND BASKETS, TRAYS 12 IN<sup>5/8</sup> AND SALAD BOWLS  
SOPORTES PARA RONDO, BANDEJAS 32 CM, BOL Y ENSALADERAS

230745  
**SUPPORT ROND BAS**  
ROUND STAND, LOW LEVEL  
SOPORTE REDONDO BAJO  
Ø 25 CM X H 13 CM  
Ø 9 IN<sup>13/16</sup> X H 5 IN<sup>1/8</sup>

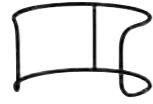

234564  
**SALADIER BAS GRÈS CARBONE<sup>(1)</sup>**  
GREY STONEWARE LOW SALAD BOWL  
ENSALADERA GRÉS TAMANO BAJO  
TONO CARBONO  
Ø 25,4 X 7 CM - 2,4 L  
Ø 10 IN X 2 IN<sup>3/4</sup> - 80 OZ<sup>1/8</sup>



234563  
**SALADIER HAUT GRÈS CARBONE<sup>(1)</sup>**  
GREY STONEWARE HIGH SALAD BOWL  
ENSALADERA GRÉS TAMANO ALTO  
TONO CARBONO  
Ø 25,4 X 13 CM - 5,1 L  
Ø 10 IN X 5 IN<sup>1/8</sup> - 172 OZ<sup>7/16</sup>



230748  
**PANIÈRE RONDE**  
ROUND BREAD BASKET  
CESTA BOLLERÍA REDONDA  
Ø 32 CM X H 8 CM  
Ø 12 IN<sup>5/8</sup> X H 3 IN<sup>1/8</sup>



230750  
**PANIÈRE INDIVIDUELLE**  
INDIVIDUAL BREAD BASKET  
CESTA BOLLERÍA INDIVIDUAL  
Ø 18 CM X H 6 CM  
Ø 7 IN<sup>1/16</sup> X H 2 IN<sup>3/8</sup>



**NEW**

235223  
**SALADIER BAHIA DUNE**  
BEIGE DUNE BOWL  
ENSALADERA BEIS DUNA  
25 CM - 4L  
11 IN - 135 OZ<sup>1/4</sup>



**NEW**

235222  
**SALADIER BAHIA BLEU ROCHE**  
BLUE STONE BOWL  
ENSALADERA AZUL DE ROCA  
25 CM - 4L  
11 IN - 135 OZ<sup>1/4</sup>



<sup>(1)</sup> COMPATIBLE LAVE-VAISSELLE  
DISH WASHER SAFE  
GARANTIA LAVA-VAJILLAS  
COMPATIBLE MICRO-ONDES  
MICROWAVE SAFE  
GARANTIA MICRO-ONDAS

230746  
**SUPPORT ROND HAUT**  
ROUND STAND, HIGH LEVEL  
SOPORTE REDONDO ALTO  
Ø 25 CM X H 26 CM  
Ø 9 IN<sup>13/16</sup> X H 10 IN<sup>1/4</sup>



136524  
**PLATEAU ROND  
PORCELAINE MODULO**  
PIE/PIZZA PLATE, FLAT  
FUENTE PARA PASTEL  
Ø 32 CM - 12 IN<sup>5/8</sup>



234561  
**PLATEAU ROND  
MÉLAMINE BOIS<sup>(2)</sup>**  
WOOD MELAMINE  
ROUND TRAY  
BANDEJA REDONDA  
MELAMINA MADERA  
Ø 32 CM - 12 IN<sup>5/8</sup>

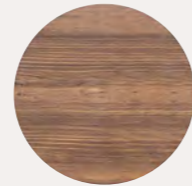

234562  
**PLATEAU ROND  
MÉLAMINE PIERRE<sup>(2)</sup>**  
STONE MELAMINE  
ROUND TRAY  
BANDEJA REDONDA  
MELAMINA PIEDRA  
Ø 32 CM - 12 IN<sup>5/8</sup>



230754  
**PLATEAU ROND  
VERRE GRIS**  
GREY ROUND TRAY  
TEMPERED GLASS  
BANDEJA CRISTAL  
REDONDA  
Ø 32 CM - 12 IN<sup>5/8</sup>



<sup>(2)</sup> COMPATIBLE LAVE-VAISSELLE  
DISH WASHER SAFE  
GARANTIA LAVA-VAJILLAS  
NON COMPATIBLE MICRO-ONDES  
DONT USE WITH MICRO-WAVE  
NO VA EN EL MICRO-ONDAS

© Patrick ROUGEREAU

Supports à fil ronds

EVENTO





## ACCESSOIRES

ACCESSORIES - ACCESORIOS

### 230751 PANIÈRE À BAGUETTE

BAGUETTE BASKET  
CESTA PARA BAGUETTE  
27 CM X H 52 CM  
10 IN<sup>5/8</sup> X H 20 IN<sup>1/2</sup>



### 234559 PLANCHA AVEC MANCHE MÉLAMINE BOIS<sup>(1)</sup>

WOOD MELAMINE BOARD  
PLANCHA CON MANGO  
MELAMINA MADERA  
17,5 X 45 CM - 6 IN<sup>7/8</sup> X 17 IN<sup>11/16</sup>



### 234560 PLANCHA AVEC MANCHE MÉLAMINE PIERRE<sup>(1)</sup>

STONE MELAMINE BOARD  
PLANCHA CON MANGO  
MELAMINA PIEDRA  
17,5 X 45 CM - 6 IN<sup>7/8</sup> X 17 IN<sup>11/16</sup>



### 202632 ÉTIQUETTE PORCELAIN AVEC AIMANT + SUPPORT ACIER

PORCELAIN STICK + STAINLESS STEEL  
STAND + MAGNET  
ETIQUETA PORCELANA + SOPORTE ACERO  
INOX CON IMAN  
10 X 5 CM - 3 IN<sup>15/16</sup> X 1 IN<sup>15/16</sup>



### 202633 SUPPORT COUVERTS DE SERVICE PORCELAIN

SERVING CUTLERY DISPLAY  
WHITE PORCELAIN  
SOPORTE PARA PIEZAS DE SERVICIO  
PORCELANA BLANCA  
21 X 10 X 5 CM  
8 IN<sup>1/4</sup> X 3 IN<sup>15/16</sup> X 1 IN<sup>15/16</sup>



### 168845 CUILLÈRE À SPAGHETTI

SPAGHETTI SERVING SPOON  
CUCHARA PARA ESPAGUETIS  
29 CM - 11 IN<sup>7/16</sup>



### 168844 FOURCHETTE À VIANDE

MEAT FORK  
TENEDOR DE CARNE  
29 CM - 11 IN<sup>7/16</sup>



### 130610 REPOSE CUILLÈRE PORCELAIN

SPOON REST WITH CERAMIC BOWL  
CUCHARA DESCANSA EN PORCELANA  
H 23,5 CM X L 11,5 CM - 9 IN<sup>3/4</sup> X 4 IN<sup>1/2</sup>



### 153193 LOUCHE ASTRÉE MIROIR

SOUP LADLE  
CAZO  
29,7 CM - 11 IN<sup>11/16</sup>



202854 **PLANCHE À PAIN BAMBOU AVEC RÉCUPÉRATEUR DE MIETTES (GN 1/1)**  
BAMBOO BREAD BOARD WITH CRUMB TRAY (GN 1/1)  
PANERA BAMBOO CON RECOGEDOR DE MIGAS (GN 1/1)  
53 X 32,5 CM - 20 IN<sup>7/8</sup> X 12 IN<sup>13/16</sup>



### 229516 COUTEAU L'ECONOME BY STARCK®

POSITIONNABLE DANS LA PLANCHE  
L'ECONOME BY STARCK® BREAD KNIFE FITS  
IN A SLOT IN THE BREAD BOARD  
CUCHILLO DE PAN L'ECONOME BY STARCK®  
SE ENCAJA EN UNA RANURA DE LA PANERA  
24 CM - 9 IN<sup>7/16</sup>



### 217814 COUTEAU L'ECONOME ECO NATURE®

POSITIONNABLE DANS LA PLANCHE  
L'ECONOME ECO NATURE® BREAD KNIFE FITS  
IN A SLOT IN THE BREAD BOARD  
CUCHILLO DE PAN L'ECONOME ECO NATURE®  
SE ENCAJA EN UNA RANURA DE LA PANERA  
18 CM - 7 IN<sup>7/16</sup>



### 217814 PRÉSENTOIR À GÂTEAUX ROND

ROUND APP / PIZZA / PRESENTATION STAND  
EXPOSITOR DE TARTAS



209381

Ø 25 CM - 9 IN<sup>13/16</sup>

209382

Ø 32 CM - 12 IN<sup>5/8</sup>

### 202625 BOL EVENTO BLANC

WHITE EVENTO BOWL  
BOL EVENTO BLANCO  
22 CM - 8 IN<sup>11/16</sup>



### 142722 BOL PORCELAINE MODULO

DEEP BOWL, LARGE  
BOL HONDO  
28 CM - 11 IN  
CONTENANCE : 2,5 L  
CAPACITY : 84 OZ<sup>9/16</sup>  
H : 12 CM - 4 IN<sup>3/4</sup>



### 204499 184355 PINCE À SERVIR

SERVING TONG  
PINZAS PARA SERVIR  
29,5 CM - 11 IN<sup>5/8</sup>



### 204498 101492 PINCE À PAIN

BREAD TONG  
PINZAS PAN  
23 CM - 9 IN<sup>1/16</sup>



### 204496 101494 CISEAUX À GÂTEAUX

PASTRY SCISSORS/TONG  
PINZAS PARA PASTELES  
20 CM - 7 IN<sup>7/8</sup>



### 130994 CUILLÈRE À TOAST

APPETIZER SPOON  
CUCHARA APERITIVO  
11,8 CM - 4 IN<sup>5/8</sup>



<sup>(1)</sup> COMPATIBLE LAVE-VAISSELLE  
DISH WASHER SAFE  
GARANTIA LAVA-VAJILLAS

NON COMPATIBLE MICRO-ONDES  
DONT USE WITH MICRO-WAVE  
NO VA EN EL MICRO-ONDAS

<sup>(1)</sup> PLANCHE DE PRÉSENTATION UNIQUEMENT, NE PAS FAIRE DE DÉCOUPE  
PRESENTATION BOARD, DON'T CUT ON IT  
PLANCHA DE PRESENTACIÓN, NO ES COMPATIBLE CON EL CORTE

© Patrick ROUGÉREAU





29,5 CM - 11 IN<sup>5/8</sup>

56,5 CM - 22 IN<sup>1/4</sup>

56,5 CM - 22 IN<sup>1/4</sup>

56,5 CM - 22 IN<sup>1/4</sup>

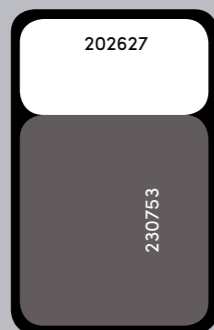
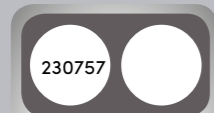
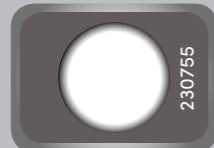
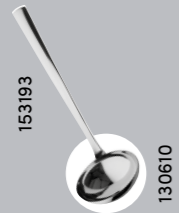

36 CM - 14 IN<sup>3/16</sup>

41 CM - 16 IN<sup>1/8</sup>



35,5 CM - 14 IN



35,5 CM - 14 IN



68,2 CM - 26 IN<sup>7/8</sup>

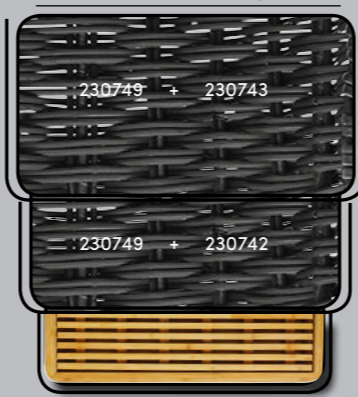

230744 + 202854 + 230741

44 CM - 14 IN



Ø 27 CM X H 52 CM  
Ø 10 IN<sup>5/8</sup> X H 20 IN<sup>1/2</sup>



Ø 25,4 CM X H 13 CM  
Ø 10 IN X H 5 IN<sup>1/8</sup>



234562  
Ø 32 CM - 12 IN<sup>5/8</sup>



20 CM - 7 IN<sup>7/8</sup>

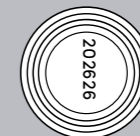
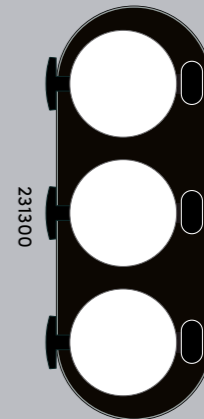

32 CM - 12 IN<sup>5/8</sup>

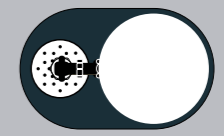
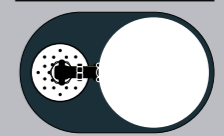

35,5 CM - 14 IN

50 CM - 19 IN<sup>1/8</sup>

20 CM  
7 IN<sup>7/8</sup>

20 CM  
7 IN<sup>7/8</sup>



**CHAFING DISH**

203470  
**COUVERCLE AVEC GOUTTIÈRE  
ACIER ET VERRE TREMPÉ**  
LID WITH STAINLESS STEEL GUTTER,  
TEMPERED GLASS  
TAPA EN ACERO INOX  
Y VIDRIO TEMPLADO  
Ø 33 CM - Ø 13 IN

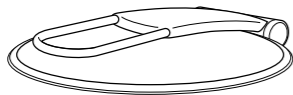

217435  
**KIT SAV VÉRINS POUR CHAFING DISH**  
REPLACING KIT FOR CHAFING DISH CYLINDER  
KIT PARA CAMBIAR EL CILINDRO DE UN CHAFING DISH

227406  
**JOINT POUR CHAFING DISH**  
SEAL FOR CHAFING DISH  
JUNTA PARA CHAFING DISH

**MODULE FROID**  
REFRIGERATED UNIT - MODULO REFRIGERADOS

202866  
**BAC PLASTIQUE**  
PLASTIC TRAY  
BANDEJA  
56 X 35,5 X 8 CM  
22 IN<sup>1/16</sup> X 14 IN X 3 IN<sup>1/8</sup>



235357  
**BAC PLASTIQUE**  
PLASTIC TRAY  
BANDEJA  
29,5 X 35,6 CM  
11 IN<sup>5/8</sup> X 14 IN



**URNE À JUS DE FRUITS**  
FRUIT JUICE URN - DISPENSADOR DE ZUMOS

**COUVERCLE URNE ACIER 18-10**  
LID FOR STAINLESS DISPENSER 18-10  
TAPA PARA ACERO DISPENSADOR 18-10  
Ø 17,9 CM - 7 IN<sup>1/16</sup>

202881 **MIROIR** 202891 **BROSSÉ**  
MIRROR BRUSHED  
ACABADO BRILLO ACABADO SATINADO

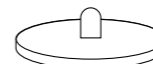

202884  
**TUBE ACIER POUR GLACE**  
ICE TUBE STAINLESS STEEL  
TUBO PARA HIELO ACERO 18-10  
Ø 9 CM - 3 IN<sup>3/16</sup>

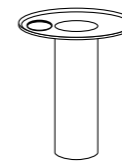

202883  
**FÛT CYLINDRIQUE URNE**  
CONTAINER FOR DISPENSER  
CONTENEDOR PARA EL DISPENSADOR SAN  
5L - 169 OZ<sup>1/16</sup>  
Ø 17,7 CM X H 25,5 CM  
Ø 6 IN<sup>15/16</sup> X H 10 IN<sup>1/16</sup>

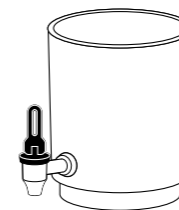

214724  
**ROBINET ACIER**  
STAINLESS STEEL FAUCET  
GRIFO ACERO  
+ ABS NOIR, BLACK, NEGRO

**BASE ACIER 18-10 URNE**  
STAINLESS STEEL STAND FOR DISPENSER 18-10  
SOPORTE ACERO PARA DISPENSADOR 18-10  
Ø 17,6 CM - H 19 CM  
Ø 6 IN<sup>15/16</sup> X H 7 IN<sup>1/2</sup>

202890 **MIROIR** 202889 **BROSSÉ**  
MIRROR BRUSHED  
ACABADO BRILLO ACABADO SATINADO

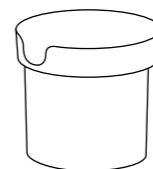

045963  
**GRILLE ACIER POUR GOUTTES - 18/10**  
STAINLESS STEEL GRID DROP COLLECTOR  
REJILLA DE ACERO PARA RECOGER EL GOTEÓ  
Ø 9 CM - 3 IN<sup>3/16</sup>



230758  
**SOCLE NOIR ACRYLIQUE URNE**  
STAND FOR BLACK DISPENSER  
BASE DEL DISPENSADOR NEGRO  
20 X 32 CM  
7 IN<sup>7/8</sup> X 12 IN<sup>5/8</sup>  
ÉPAISSEUR/ESPESOR : 2 CM  
THICKNESS: 13/16 IN



**EVENTO**

**DISTRIBUTEUR À CÉRÉALES**  
CEREALES DISPENSER - DISPENSADOR DE CEREALES

213078  
**COUVERCLE DISTRIBUTEUR CEREALES  
ACIER FINITION MIROIR - 18/10**  
LID FOR CEREAL DISPENSER, STAINLESS STEEL,  
MIRROR FINISH  
TAPA PARA DISPENSADOR EN BRILLO, ACERO  
Ø 12,5 CM - Ø 4 IN<sup>15/16</sup>



213076  
**FÛT CYLINDRIQUE AVEC AILETTE  
ET POIGNEE DISTRIBUTEUR CEREALES**  
BARREL + HANDLE + ROLLING TAP  
FOR CEREAL DISPENSER  
CONTENEDOR PARA EL DISPENSADOR  
CON ALETA Y ASA  
P 16,1 X H 42 CM - D 6 IN<sup>5/16</sup> X H 16 IN<sup>9/16</sup>

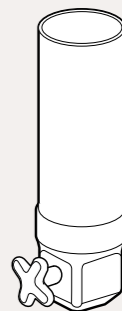

231301  
**BASE + TUBE + SOCLE X1  
DISTRIBUTEUR À CEREALES**  
STAINLESS STEEL STAND + TUB  
+ ACRYLIC STAND FOR CEREAL DISPENSER  
BASE + TUBO + ZÓCALO DISPENSADOR  
DE CEREALES  
L 19 X H 27,5 CM - L 7 IN<sup>1/2</sup> X H 29 IN<sup>3/4</sup>

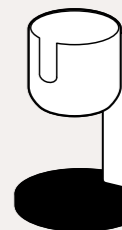

231302  
**BASE + TUBE + SOCLE X3  
DISTRIBUTEUR À CEREALES**  
STAINLESS STEEL STAND + TUB  
+ ACRYLIC STAND FOR CEREAL DISPENSER  
BASE + TUBO + ZÓCALO  
X3 DISPENSADOR DE CEREALES  
L 50 X H 27,5 CM - L 19 IN<sup>11/16</sup> X H 29 IN<sup>3/4</sup>

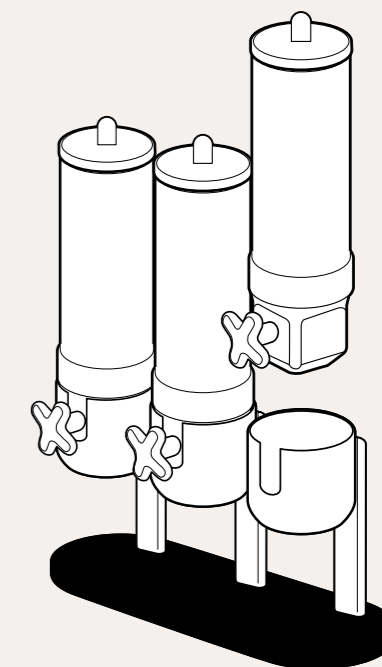
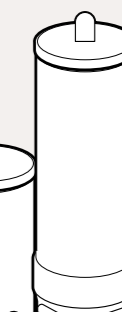



## CUISINE

Véritable tradition pour DEGRENNE, le culinaire se décline en **ustensiles de cuisson, de préparation, de découpe et d'affutage**, pour inviter les chefs à la réalisation de recettes savoureuses et délicates. Les gammes coutellerie l'**Unique Sabatier** ainsi que les ustensiles de préparation de la célèbre marque **L'Econome®**, sont **gages de qualité et témoignent d'un véritable esprit précurseur** dans l'histoire de la cuisine française. Experte dans le travail de l'acier et notamment sur l'embouti, DEGRENNE présente également **Newcook Expert, une gamme d'ustensiles de cuisson 100% fabriquée en France**. En alliant **précision, technologie** Multiply et **design**, Newcook Expert promet des moments de création uniques.

## KITCHENWARE

Kitchenware is a real tradition at DEGRENNE and our range comprises **cooking, preparation, slicing and sharpening utensils** to encourage chefs to make flavoursome and delicate dishes. The **Unique Sabatier** cutlery ranges and the famous **L'Econome®** brand's food preparation utensils, are a **guarantee of quality** and bear witness to a trailblazing spirit in the history of French cuisine. DEGRENNE has steel-working and specifically metal stamping expertise, and is also presenting **Newcook Expert, a range of cooking utensils entirely made in France**. Newcook Expert promises unique creative moments, as the range combines **precision, Multiply technology** and **great design**.

## COCINA

Verdadera tradición para DEGRENNE, lo culinario se declina en **utensilios de cocción, de preparación, de corte y de afilado**, para invitar a los chefs a la preparación de recetas sabrosas y delicadas. Las gamas de cuchillería, **Unique Sabatier**, así como los utensilios de preparación de la famosa marca, **L'Econome®**, son garantía de calidad y dan fe de un verdadero espíritu pionero en la historia de la cocina francesa. Experta en el trabajo del acero, sobre todo en el estampado, DEGRENNE también presenta **Newcook Expert, una gama de utensilios de cocina, 100 % fabricada en Francia**. Aliando **precisión, tecnología** Multiply y **diseño**, Newcook Expert promete momentos de creación únicos.



**COUPEAU OFFICE**  
PARING KNIFE  
CUCHILLO MONDADOR  
8 CM - 3 IN<sup>1/16</sup>  
218590 IDÉAL FORGÉ



**COUPEAU OFFICE**  
PARING KNIFE  
CUCHILLO MONDADOR  
10 CM - 4 IN  
218587 IDÉAL FORGÉ  
218591 IDÉAL FORGÉ OLIVIER



**COUPEAU OFFICE BEC OISEAU**  
CURVED BLADE PARING KNIFE  
CUCHILLON MONDADOR PICO DE PAJARO  
8 CM - 3 IN<sup>1/16</sup>  
218585 IDÉAL FORGÉ



**COUPEAU DE CUISINE**  
CHEF'S KNIFE  
CUCHILLO DE COCINA  
15 CM - 6 IN  
218593 IDÉAL FORGÉ  
218595 IDÉAL FORGÉ OLIVIER



**COUPEAU DE CUISINE**  
CHEF'S KNIFE  
CUCHILLO DE COCINA  
20 CM - 8 IN  
218596 IDÉAL FORGÉ  
218599 IDÉAL FORGÉ OLIVIER



**COUPEAU DE CUISINE**  
CHEF'S KNIFE  
CUCHILLO DE COCINA  
25 CM - 10 IN  
218600 IDÉAL FORGÉ  
218602 IDÉAL FORGÉ OLIVIER



**COUPEAU TRANCHELARD**  
SLICING KNIFE  
CUCHILLO PARA CORTAR  
15 CM - 6 IN  
218609 IDÉAL FORGÉ  
218612 IDÉAL FORGÉ OLIVIER



**COUPEAU TRANCHELARD**  
SLICING KNIFE  
CUCHILLO PARA CORTAR  
20 CM - 8 IN  
218613 IDÉAL FORGÉ



**COUPEAU TRANCHELARD**  
SLICING KNIFE  
CUCHILLO PARA CORTAR  
25 CM - 10 IN  
218616 IDÉAL FORGÉ



**COUPEAU SANTOKU**  
SANTOKU KNIFE GRANTON EDGE  
CUCHILLO SANTOKU  
18 CM - 7 IN<sup>1/16</sup>  
218629 IDÉAL FORGÉ  
218630 IDÉAL FORGÉ OLIVIER



**COUPEAU FILET DE SOLE**  
FILETING KNIFE  
CUCHILLO PARA FILETAR  
15 CM - 6 IN  
218611 IDÉAL FORGÉ

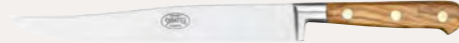

**COUPEAU À JAMBON ALVÉOLÉ**  
HAM SLICER HOLLOW EDGE  
CUCHILLO JAMONERO ALVEOLADO  
30 CM - 12 IN  
218583 IDÉAL FORGÉ

**COUPEAU À DÉOSSER**  
BONING KNIFE  
CUCHILLO DESHUESADOR  
13 CM - 5 IN  
218626 IDÉAL FORGÉ

**COUPEAU À DÉOSSER**  
BONING KNIFE  
CUCHILLO DESHUESADOR  
15 CM - 6 IN  
218628 IDÉAL FORGÉ

**FUSIL À AIGUISER-ABS**  
SHARPENING STEEL-ABS  
AFILADOR-ABS  
30 CM - 12 IN  
217879 AFFUTAGE COUTELLERIE

**FUSIL À AIGUISER**  
SHARPENING STEEL  
AFILADOR  
25 CM - 10 IN  
217880 IDÉAL FORGÉ

**FUSIL À AIGUISER**  
SHARPENING STEEL  
AFILADOR  
20 CM - 8 IN  
217883 IDÉAL FORGÉ OLIVIER

**COUPEAU À DÉCOUPER YATAGAN**  
YATAGAN CARVING KNIFE  
CUCHILLO DE TRINCHAR YATAGAN  
20 CM - 8 IN  
218623 IDÉAL FORGÉ  
218625 IDÉAL FORGÉ OLIVIER

**FOURCHETTE À VIANDE**  
MEAT FORK  
TENEDOR DE CARNE  
17 CM - 6 IN<sup>11/16</sup>  
217868 IDÉAL FORGÉ  
217872 IDÉAL FORGÉ OLIVIER

**COUPEAU À STEAK**  
STEAK KNIFE  
CUCHILLO CHULETERO  
13 CM - 5 IN  
218579 IDÉAL FORGÉ

**COUPEAU À PAIN**  
BREAD KNIFE  
CUCHILLO DE PAN  
20 CM - 8 IN  
218619 IDÉAL FORGÉ  
218622 IDÉAL FORGÉ OLIVIER



**L'ÉCONOME® ECO NATURE**  
NATURAL HUE - TINTE NATURAL



217523  
**ÉCONOME**  
PEELER  
PELADOR  
10 CM - 4 IN



217687  
**COUPEAU OFFICE POINTU**  
PARING KNIFE  
CUCHILLO MONDADOR  
9 CM - 3 IN <sup>15/16</sup>



226270  
**COUPEAU OFFICE BEC OISEAU**  
CURVED BLADE PARING KNIFE  
CUCHILLON MONDADOR PICO DE PAJARO  
6,5 CM - 2 IN <sup>5/8</sup>



217804  
**COUPEAU À DÉCOUPER**  
CARVING KNIFE  
CUCHILLO DE TRINCHAR  
20 CM - 8 IN



217806  
**COUPEAU DE CUISINE**  
CHEF'S KNIFE  
CUCHILLO DE COCINA  
15 CM - 6 IN



217808  
**COUPEAU DE CUISINE**  
CHEF'S KNIFE  
CUCHILLO DE COCINA  
20 CM - 8 IN



217814  
**COUPEAU À PAIN**  
BREAD KNIFE  
CUCHILLO DE PAN  
18 CM - 7 IN <sup>11/16</sup>

**L'ÉCONOME**  
BY  
STARCK®

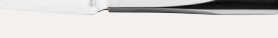

229514  
**PACK 4 PIECES - ECONOME/  
COUPEAU BEC OISEAU/  
FLEXICONOME/COUPEAU OFFICE**  
PACK 4 PIECES SET - PEELER/  
CURVED BLADE PARING KNIFE/  
FLEXICONOME/PARING KNIFE  
PAQUETE DE 4 PIEZAS - ECONOME/  
BECK CUCHILLOS /FLEXICONOME/  
CUCHILLO MONDADOR



229515  
**COUPEAU DE CUISINE**  
CHEF'S KNIFE  
CUCHILLO DE COCINO  
14 CM - 5 IN <sup>1/2</sup>



229516  
**COUPEAU À PAIN**  
BREAD KNIFE  
CUCHILLO DE COCINO  
24 CM - 9 IN <sup>7/16</sup>

**L'ÉCONOME® BOIS LAQUÉ**  
GLOSS FINISH WOOD - MADERA LACADA



217528  
**ÉCONOME® AUBERGINE**  
PEELER PURPLE  
PELADOR BERENJENA  
10 CM - 4 IN



217529  
**ÉCONOME® MANDARINE**  
PEELER ORANGE  
PELADOR MANDARINA  
10 CM - 4 IN



217532  
**ÉCONOME® ANIS**  
PEELER ANISE  
PELADOR ANIS  
10 CM - 4 IN



217533  
**ÉCONOME® FUCHSIA**  
PEELER FUCHSIA  
PELADOR FUCHSIA  
10 CM - 4 IN



217691  
**COUPEAU OFFICE POINTU  
AUBERGINE**  
PARING KNIFE PURPLE  
CUCHILLO MONDADOR BERENJENA  
9 CM - 3 IN <sup>15/16</sup>



217692  
**COUPEAU OFFICE POINTU  
MANDARINE**  
PARING KNIFE ORANGE  
CUCHILLO MONDADOR MANDARINA  
9 CM - 3 IN <sup>15/16</sup>

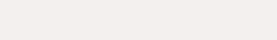

217695  
**COUPEAU OFFICE POINTU  
ANIS**  
PARING KNIFE ANISE  
CUCHILLO MONDADOR ANIS  
9 CM - 3 IN <sup>15/16</sup>

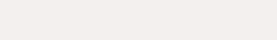

217696  
**COUPEAU OFFICE POINTU  
FUCHSIA**  
PARING KNIFE FUCHSIA  
CUCHILLO MONDADOR FUCHSIA  
9 CM - 3 IN <sup>15/16</sup>



217795  
**COUPEAU OFFICE BEC OISEAU  
AUBERGINE**  
CURVED BLADE PARING KNIFE PURPLE  
CUCHILLON MONDADOR PICO DE PAJARO BERENJENA  
6,5 CM - 2 IN <sup>5/8</sup>



217796  
**COUPEAU OFFICE BEC OISEAU  
MANDARINE**  
CURVED BLADE PARING KNIFE ORANGE  
CUCHILLON MONDADOR PICO DE PAJARO MANDARINA  
6,5 CM - 2 IN <sup>5/8</sup>



217799  
**COUPEAU OFFICE BEC OISEAU  
ANIS**  
CURVED BLADE PARING KNIFE ANISE  
CUCHILLON MONDADOR PICO DE PAJARO ANIS  
6,5 CM - 2 IN <sup>5/8</sup>



217800  
**COUPEAU OFFICE BEC OISEAU  
FUCHSIA**  
CURVED BLADE PARING KNIFE FUCHSIA  
CUCHILLON MONDADOR PICO DE PAJARO FUCHSIA  
6,5 CM - 2 IN <sup>5/8</sup>



217540  
**FLEXICONOME JULIENNE  
AUBERGINE**  
JULIENNE FLEXICONOME PURPLE  
ABADEJO FLEXICONOME BERENJENA  
9 CM - 3 IN <sup>15/16</sup>



217538  
**FLEXICONOME TOMATE  
ANIS**  
TOMATO FLEXICONOME ANISE  
TOMATO FLEXICONOME ANIS  
9 CM - 3 IN <sup>15/16</sup>



217536  
**FLEXICONOME UNIVERSEL  
FUCHSIA**  
UTILITY FLEXICONOME FUCHSIA  
UNIVERSAL FLEXICONOME FUCHSIA  
9 CM - 3 IN <sup>15/16</sup>



**L'ÉCONOME®**  
MADE IN FRANCE

**CASSEROLES - SAUCEPAN - CAZO**



223972  
**CASSEROLE**  
SAUCEPAN  
CAZO  
14 CM - 5 IN<sup>1/2</sup>

223973  
**CASSEROLE**  
SAUCEPAN  
CAZO  
16 CM - 6 IN<sup>5/16</sup>

223974  
**CASSEROLE**  
SAUCEPAN  
CAZO  
18 CM - 7 IN<sup>1/16</sup>

223975  
**CASSEROLE**  
SAUCEPAN  
CAZO  
20 CM - 7 IN<sup>7/8</sup>

223993  
**ENSEMBLE DE 3 CASSEROLES**  
SET OF 3 SAUCEPAN  
SET DE 3 CAZOS  
16/18/20 CM  
6 IN<sup>5/16</sup> TO 7 IN<sup>7/8</sup>

**COUVERCLES - LIDS - TAPAS**



223987  
14 CM - 5 IN<sup>1/2</sup>

223988  
16 CM - 6 IN<sup>5/16</sup>

223989  
18 CM - 7 IN<sup>1/16</sup>

223990  
20 CM - 7 IN<sup>7/8</sup>

223991  
24 CM - 9 IN<sup>7/16</sup>

223992  
28 CM - 11 IN

**POÊLES - FRYING PAN - SARTÉN**



223977  
**POÊLE**  
FRYING PAN  
SARTÉN  
24 CM - 9 IN<sup>7/16</sup>

**COCOTTE - FRENCH OVEN - OLLA**



223979  
**POÊLE**  
FRYING PAN  
SARTÉN  
28 CM - 11 IN

223986  
**COCOTTE OVALE AVEC COUVERCLE**  
OVAL FRENCH OVEN WITH LID  
OLLA OVALADA CON TAPA  
24 X 30 CM - 11 IN<sup>1/16</sup> X 9 IN<sup>7/16</sup>

**FAITOUT - STEWPOT - OLLA**



223985  
**FAITOUT**  
STEWPOUT  
OLLA  
24 CM - 9 IN<sup>7/16</sup>

ACIER INOXYDABLE  
STAINLESS STEEL  
ACERO INOXIDABLE

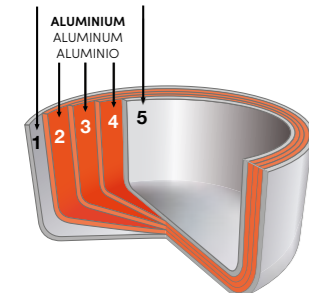

**CONDUCTION HOMOGENE ET OPTIMALE DE LA CHALEUR DU FOND JUSQU'EN HAUT DES PAROIS POUR UNE PARFAITE MAÎTRISE DE LA TEMPÉRATURE DE CUISSON**

**CORPS EXTÉRIEUR EN FINITION INOX ET INTÉRIEUR BROSSÉ**

**GRADUATION INTÉRIEURE DES LITRAGES**

**PERFORMANCES PROCHES DES QUALITÉS DE CUISSON OBTENUES AVEC DES USTENSILES EN CUIVRE OU EN FONTE**

**COMPATIBLE TOUS FEUX DONT INDUCTION**

UNIFORM AND OPTIMAL HEAT CONDUCTION FROM THE BASE OF THE PAN TO THE TOP OF THE SIDES FOR A PERFECT CONTROL OF THE COOKING TEMPERATURE

OUTER BODY IN STAINLESS STEEL FINISH AND INSIDE IN BRUSHED STAINLESS STEEL

INTERNAL LITRE SCALE

THE PERFORMANCE IS CLOSE TO COOKING QUALITIES USUALLY OBTAINED FROM COOKING WITH COPPER OR CAST IRON COOKWARE

SUITABLE FOR ALL HOB TYPES INCLUDING INDUCTION

CONDUCCIÓN HOMOGENEA Y ÓPTIMA DEL CALOR DEL FONDO HASTA ARRIBA DE LAS PAREDES PARA UN PERFECTO CONTROL DE LA TEMPERATURA DE COCCIÓN

CUERPO EXTERIOR EN ACABADO DE ACERO INOXIDABLE E INTERIOR EN MATE

GRADUACIÓN INTERIOR DE LOS LITROS

RENDIMIENTOS CERCANOS A LAS CALIDADES DE COCCIÓN OBTENIDAS CON USTENSILIOS DE COBRE O HIERRO FUNDIDO

COMPATIBLE CON TODO TIPO DE FUEGOS, INCLUIDOS LO DE INDUCCIÓN

**NEWCOOK EXPERT**

MADE IN FRANCE





---

## SERVICE DE RÉASSORT R

---

**D**EGRENNE s'engage à vos côtés en vous offrant la possibilité d'effectuer **une commande de réassort pendant les 3 années qui suivent l'arrêt de commercialisation de nos couverts**. Ce service s'applique aux collections identifiées dans ce catalogue par ce pictogramme. Dans le cadre de ce service, **vous avez la possibilité de commander les pièces qui vous manquent, une fois par an et selon les conditions définies** : contactez nos équipes commerciales pour toute demande. Le service de réassort est valable pour les pièces suivantes : Fourchette de table – Cuillère de table – Couteau de table (excepté couteaux monoblocs) – Fourchette à poisson – Couteau à poisson – Fourchette à dessert – Cuillère à dessert – Couteau à dessert (excepté couteaux monoblocs) – Cuillère à café – Cuillère à moka.

---

## REPLACEMENT PRODUCT SERVICE R

---

DEGRENNÉ enables you to **order replacement products for a further three years after cutlery is discontinued**. This service applies to the collections bearing the logo in the catalogue. This service enables you to **order any items you need once a year and in accordance with the following terms and conditions**: please contact our sales teams if you need to order any products. The replacement products service is available for the following products: table fork, table spoon, table knife (excluding solid handle knife) fish fork, fish knife, dessert fork, dessert spoon, dessert knife (excluding solid handle knife) coffee/tea spoon and moka spoon.

---

## SERVICIOS R

---

DEGRENNÉ se compromete a ofrecerle la **posibilidad de efectuar un pedido de renovación de existencias durante los 3 años siguientes al final de la comercialización de nuestros cubiertos**. Ese servicio se aplica a las colecciones identificadas en este catálogo con el pictograma. En el marco de ese servicio, **tiene la posibilidad de pedir las piezas que le falten, una vez al año y según las condiciones definidas**: póngase en contacto con nuestros equipos comerciales para cualquier solicitud. El servicio de renovación de existencias es válido para las siguientes piezas : Tenedor de mesa – Cuchara de mesa – Cuchillo de mesa (salvo cuchillo pesado) – Tenedor de pescado – Cuchillo de pescado – Tenedor de postre – Cuchara de postre – Cuchillo de postre (salvo cuchillo pesado) – Cucharilla de café – Cucharilla de moka.





---

## SERVICE DE PERSONNALISATION

---

Créez votre table personnalisée grâce au savoir-faire DEGRENNE. **DEGRENNE rend votre table unique grâce à ses services de personnalisation** : couverts, verres, plateaux ou vaisselle, découvrez un large choix de produits et de finitions. Chaque projet de personnalisation est un **service sur-mesure** qui fait l'objet d'une **étude personnalisée** par nos commerciaux.

---

### CUSTOM - MADE SERVICE

---

Use DEGRENNE's expertise to create your own table. **DEGRENNE's custom - made service can make your table unique**: explore our wide range of products and finishes, including cutlery, glasses, trays and tableware. Our sales executives deliver **a bespoke service for each and every personalization order**.

---

### SERVICIO DE PERSONALIZACIÓN

---

Cree su mesa personalizada gracias al saber hacer de DEGRENNE. **DEGRENNE hace que su mesa sea única gracias a sus servicios de personalización**: cubiertos, copas, bandejas o vajilla, descubra una amplia elección de productos y de acabados. Cada proyecto de personalización es un **servicio a medida** que es objeto de un **estudio personalizado** por parte de nuestros comerciales.



## VERRERIE

GLASSWARE  
COPAS

AJOUTEZ VOTRE LOGO SUR LE PIED DU VERRE  
AJOUTEZ VOTRE LOGO OU UN TRAIT DE JAUGE SUR LA PARAISSON  
(LE LOGO SUR LA PARAISSON PEUT ÉGALEMENT FAIRE OFFICE DE JAUGE)

ADD YOUR LOGO TO THE BASE OF THE GLASS  
ADD YOUR LOGO OR A MEASURE MARKING ON THE BOWL  
(THE LOGO ON THE BOWL CAN ALSO BE USED AS THE MEASURE MARKING)

AÑADA SU LOGOTIPO EN LA BASE DE LA COPA  
AÑADA SU LOGOTIPO O UN INDICADOR DE NIVEL EN EL CÁLIZ  
(EL LOGOTIPO EN EL CÁLIZ TAMBIÉN PUEDE SERVIR COMO INDICADOR DE NIVEL)



## VAISSELLE

DINNERWARE  
VAJILLA

AJOUTEZ VOTRE LOGO  
RÉALISEZ UN DÉCOR SPÉCIFIQUE  
APPLIQUEZ UN FILET DE LA COULEUR DE VOTRE CHOIX

ADD YOUR LOGO  
ADD A SPECIAL PATTERN  
APPLY A THIN STRIPE OF THE COLOUR OF YOUR CHOICE

AÑADA SU LOGOTIPO  
REALICE UNA DECORACIÓN ESPECÍFICA  
APLIQUE UN BORDE DE COLOR DE SU ELECCIÓN





# COUVERTS FLATWARE CUBIERTOS & PLATERIE HOLLOWARE ORFEBRERÍA

AJOUTEZ VOTRE LOGO : EN FONCTION DE VOS ATTENTES, NOUS PROPOSONS LA GRAVURE LASER POUR UNE GRANDE PRÉCISION OU LE MARQUAGE AU POINÇON POUR UNE TENUE INALTÉRABLE DANS LE TEMPS

ADD YOUR LOGO : IN ACCORDANCE WITH YOUR REQUIREMENTS, WE OFFER LASER ENGRAVING IF HIGH PRECISION IS NEEDED, OR ALTERNATIVELY METAL STAMPING FOR ITEMS NEEDING TO STAND THE TEST OF TIME

AÑADA SU LOGOTIPO: EN FUNCIÓN DE SUS EXPECTATIVAS, LE PROPONEMOS EL GRABADO LÁSER PARA UNA GRAN PRECISIÓN O EL MARCADO CON PUNZÓN PARA UNA RESISTENCIA EN EL TIEMPO INALTERABLE

# PERSONNALISEZ VOTRE FINITION

PERSONALIZE THE FINISH  
PERSONALICE SU ACABADO

L'ARGENTURE AVEC POINÇON DE MAÎTRE : ARGENTURE DE CLASSE I (33 MICRONS POUR LES ARTICLES À USAGE FRÉQUENT) OU ARGENTURE QUALITÉ HÔTELIÈRE (10 MICRONS)

SILVER PLATING WITH A MAKER'S MARK: CLASS I SILVER PLATING (33 MICRONS FOR FREQUENTLY USED ITEMS) OR HOTEL QUALITY SILVER-PLATING (10 MICRONS)

LA PLATEADURA CON PUNZÓN DE MAESTRO: PLATEADURA DE CLASE I (33 MICRONES PARA LOS ARTÍCULOS DE USO FRECUENTE) O PLATEADURA DE CALIDAD HOTELERA (10 MICRONES)



LA FINITION PVD: PROCÉDÉ DE MÉTALLISATION QUI PERMET DE RÉALISER UN PLACAGE IONIQUE. DISPONIBLE DANS LES COLORIS NOIR, DORÉ, CUIVRE ET HOLOGRAPHIC SOUS CONDITIONS PARTICULIÈRES, CONTACTEZ NOS ÉQUIPES.

PVD FINISH: VACUUM DEPOSIT METALLIZATION PROCESS. AVAILABLE IN BLACK, GOLD, COPPER AND HOLOGRAPHIC COLORS UNDER SPECIAL CONDITIONS, CONTACT OUR SALES TEAMS.

RECUBRIMIENTO PVD: PROCEDIMIENTO DE METALIZACIÓN POR DEPÓSITO AL VACÍO. DISPONIBLE EN LOS COLORIDOS NEGRO, DORADO, COBRE Y HOLOGRÁFICA BAJO CONDICIONES PARTICULARES, PÓNGASE EN CONTACTO CON NUESTROS EQUIPOS.



LA DORURE : DORURE À L'OR FIN DES COUVERTS OU DE CERTAINES PARTIES DES COUVERTS

GILDING : CUTLERY OR ALTERNATIVELY SOME SECTIONS OF CUTLERY CAN BE GILDED WITH FINE GOLD

LA DORADURA : DORADURA CON ORO FINO DE LOS CUBIERTOS O DE ALGUNAS PARTES DE LOS CUBIERTOS



LA FINITION ÉTAÏN : POLISSAGE SPÉCIFIQUE DES COUVERTS POUR UN EFFET VIEILLI FAÇON ÉTAÏN

PEWTER FINISH: SPECIALLY POLISHED CUTLERY FOR A PEWTER-STYLE ANTIQUE EFFECT

EL ACABADO DE ESTAÑO : PULIDO ESPECÍFICO DE LOS CUBIERTOS PARA UN EFECTO ENVEJECIDO TIPO ESTAÑO



LA FINITION BROSSÉE OU SATINÉE : POLISSAGE SPÉCIFIQUE DES COUVERTS OU DES ACCESSOIRES DE PLATERIE POUR UN RENDU MAT

BRUSHED OR SATIN FINISH: SPECIALLY POLISHED CUTLERY AND HOLLOWWARE ACCESSORIES FOR A MATT FINISH

EL ACABADO MATE O SATINADO : PULIDO ESPECÍFICO DE LOS CUBIERTOS O DE LOS ACCESORIOS DE PLATERÍA PARA UN ACABADO MATE

A series of horizontal dotted lines for writing notes.



A series of horizontal dotted lines for writing notes.





**GARANTIE MICRO-ONDES**  
MICROWAVE SAFE  
GARANTÍA MICRO-ONDAS



**GARANTIE LAVE-VAISSELLE**  
DISHWASHER SAFE  
GARANTÍA LAVA-VAJILLAS



**GARANTIE CONGÉLATEUR**  
FREEZER SAFE  
GARANTÍA CONGELADOR



**GARANTIE FOUR**  
OVEN SAFE  
GARANTÍA HORNO



**FINITION MÉTAL ARGENTÉ - ARGENTURE**  
**CLASSE 1 - 33 MICRONS (POUR LES**  
**ARTICLES À USAGE FRÉQUENT)**  
SILVER PLATED FINISH - CLASS 1 SILVERPLATING -  
33 MICRONS  
ACABADO PLATEADO - TIPO CLASE 1 - 33 MICRAS



**ARGENTURE QUALITÉ HÔTELIÈRE-10 MICRONS**  
SILVER PLATED HOTEL QUALITY- 10 MICRONS  
ACABADO HOTEL QUALITY - 10 MICRONES



**FINITION MIROIR**  
MIRROR FINISH  
ACABADO BRILLO



**FINITION SATINÉE**  
SATIN FINISH  
ACABADO CEPILLADO



**FINITION VINTAGE**  
VINTAGE FINISH  
ACABADO VINTAGE



**FORGÉ**  
FORGED  
FORJADO



**ACIER INOXYDABLE**  
STAINLESS STEEL  
ACERO INOXIDABLE



**EPAISSEUR FOURCHETTE DE TABLE**  
THICKNESS TABLE FORK  
ESPESOR TENEDOR DE MESA



**RÉASSORT**  
REPLACEMENT  
RENOVACIÓN



**REVÊTEMENT PVD**  
PVD COATING  
REVESTIMIENTO PVD



**VERRE**  
GLASS  
CRISTAL



**SHQ/ SODOCALCIQUE**  
**HAUTE QUALITÉ**  
HIGH QUALITY SODA - LIME  
SODOCÁLCICO ALTA CALIDAD



**CRISTALLIN HAUTE QUALITÉ**  
HQ LOW LEAD CRYSTAL  
CRISTALINO ALTA CALIDAD



**VERRE SOUFFLÉ BOUCHE TEINTÉ**  
**DANS LA MASSE**  
HAND-BLOWN INTEGRALLY DYED GLASS  
VASO SOPLADO A BOCA, PINTADO EN MASA



**1000 CYCLES GARANTIS MINIMUM**  
1000 WASH CYCLES GUARANTEED  
1000 CICLOS DE LAVADO GARANTIZADOS



**PORCELAINE**  
PORCELAIN  
PORCELANA



**PORCELAINE DE LIMOGES**  
LIMOGES PORCELAIN  
PORCELANA DE LIMOGES



**AIMANTÉ**  
WITH MAGNET  
CON IMÁN



**GRÈS**  
STONEWARE  
ARENISCA

MARQUES DÉPOSÉES / COPYRIGHTS / MARCAS REGISTRADAS



FRANCE USA

**SIEGE SOCIAL / HEAD OFFICE / SEDE SOCIAL**  
**SERVICE CLIENTS / CUSTOMER SERVICES / ATENCIÓN AL CLIENTE**

RUE GUY DEGRENNE - BP 50056  
14502 VIRE CEDEX  
FRANCE  
FRANCE - TEL : +33 (0)2 31 66 44 15

OTHER COUNTRIES / OTROS PAÍSES  
TEL : +33 (0)2 31 66 44 00

infohotel@degrenne.fr

**FILIALE USA / US SUBSIDIARY**

DNA/DEGRENNE NORTH AMERICA INC.  
390 GEORGE STREET - SUITE 404  
NEW BRUNSWICK, NJ 08901 - USA

TEL : 732 565 0820  
FAX : 732 565 0828

csrv.dna@degrenneparis.com  
www.degrenneparis.us

**DIRECTION GÉNÉRALE / GENERAL MANAGEMENT / DIRECCIÓN GENERAL**  
**DIRECTION MARKETING - MARKETING DIVISION - DIRECCIÓN DE MARKETING**  
**DIRECTION COMMERCIALE - SALES DIVISION - DIRECCIÓN COMERCIAL**  
**SHOWROOM (SUR RENDEZ-VOUS)**

89 RUE LA BOÉTIE  
75008 PARIS  
FRANCE

**SHOWROOM (BY APPOINTMENT)**

NEW YORK (41 MADISON)







**FRANCE**  
infohotel@degrenne.fr  
Tel : +33 (0)2 31 66 44 15

**OTHER COUNTRIES/OTROS PAISES**  
infohotel@degrenne.fr  
Tel : +33 (0)2 31 66 44 00

**FILIALE USA/US SUBSIDIARY**  
csrv.dna@degrenneparis.com  
Tel : 732 565 0820



[www.pro.degrenne.fr](http://www.pro.degrenne.fr)