



DEGRENNE

P A R I S

Since 1948



PRIX CONSEILLÉS HORS TAXES DESTINÉS AUX PROFESSIONNELS AU 1ER JANVIER 2020
EXPORT PRICE LIST ON JANUARY 1ST 2020
PRECIOS SIN IVA PARA LOS PROFESIONALES A PARTIR DEL 1 DE ENERO DE 2020

COUVERTS
FLATWARE - CUBIERTOS

p.5-44

Absolu.....	6
Aloa.....	7
Aquatic.....	8
Astrée.....	9
Astrée Ciséle.....	10
Blois.....	11
Capucin.....	43
Confidence.....	12
Florenca.....	13
Fuse NEW	14
Fuse martelé NEW	15
Guest.....	16
Guest cuivre.....	17
Guest star.....	18
Guest vintage.....	19
L'E Starck®.....	20
Laguiole.....	43
Lutèce.....	21
Marquise.....	22
Mikado.....	23
Mikado vintage.....	24
Milady.....	25
Mirage.....	26,43
Mirage Les Essences.....	43
Neuilly.....	27
Normandy.....	28
Norway.....	29
Onde.....	30
Petit Gourmet.....	31
Pièces complémentaires.....	32-33
Quartz.....	34-35
Serenity.....	36
Solstice.....	37
Squadro.....	38
Verlaine.....	39
Vieux Paris satiné.....	40
XY Miroir.....	41
XY black Miroir.....	42
Service Argenture -Silver plating -Servicio plateadura.....	44

VAISSELLE
DINNERWARE - VAJILLA

p.45-68

API.....	46
Bahia.....	46-48
Boréal blanc.....	49
Boréal satin.....	49
Cocottes.....	50-51
Collection L Couture NEW	52
Collection L.....	52
Collection L Fragment.....	53
Collection L Perles de Rosée.....	53
Eclipse.....	54
Essentielle.....	54
Graphique.....	54
La Vaisselle de l'Econome NEW	55-56
Modulo.....	57

LÉGENDE - LEGEND - LEYENDA

18%	acier inoxydable stainless steel acero inoxidable	finition brossée brushed finish acabado cepillado
épaisseur thickness espesor		forgé forged forjado
finition métal argenté silver plated finish acabado plateado		garantie lave-vaisselle dishwasher safe garantía lavavajillas
argenteur qualité hôtelière silver plated hotel quality acabado hotel quality		réassort replacement renovación
finition miroir mirror finish acabado brillo		Revêtement PVD PVD coating Revestimiento PVD
finition vintage vintage finish acabado vintage		Sélection Degrenne Degrenne's selection selección Degrenne

Modulo color.....	58
Modulo Nature.....	58-60
Mondo.....	60-61
Newcook modulo.....	62
Newport.....	62
Salam.....	63-64
Salam Accessoires.....	65
Salam Thé.....	65
Smoos.....	66

PLATERIE
HOLLOWARE - ORFEBRERIA

p.67-74

Accessoires - Accessories - Accesorios.....	68-69
Newport.....	70-73
Newport cubique.....	74
Newport Lounge.....	74
Normandy.....	74

BUFFET EVENTO
BUFFET-BUFÉ

p.75-82

Chafing dish.....	76
Module froid - Refrigerated unit -modulos refrigerados.....	77-78
Urne à jus de fruits - Fruit juice urn - Dispensadores de zumos.....	79
Distributeur à céréales - Cereal dispenser - Dispensador de cereales.....	80
Supports fils & accessoires Trays & accessories-Soportes & accesorios.....	81-82

CUISINE
KITCHENWARE - COCINA

p.83-86

Ideal forgé.....	84
Ideal forgé olivier.....	84
L'Econome®.....	85
L'Econome by Starck®.....	85
Newcook Expert.....	86

VERRES
GLASS - CRISTALERIA

p.87-93

Allegro.....	88
Anytime.....	88
Bilbao.....	89
Carafes/Décanteurs.....	89
Cosmopolitain.....	89
Dandy.....	90
Dolce.....	90
Domaine.....	90
Empilé.....	90
Galatée.....	91
Héritage NEW	91
Hypnotic jaugé.....	91
Loop.....	91
Mambo.....	92
Montmartre.....	92
Muse.....	92-93
Roc NEW	93
Origine.....	93
Oslo.....	93

porcelaine porcelain porcelana	aimanté with magnet con imán
porcelaine de Limoges Limoges porcelain porcelana de Limoges	verre glass cristal
garantie réfrigérateur freezer safe garantía congelador	cristallin HQ HQ low lead crystal cristalino alta calidad
garantie micro-ondes microwave safe garantía microondas	sodocalcique haute qualité soda-lime high quality sodocalcico alta calidad
garantie four oven safe garantía horno	verre soufflé bouche teinté dans la masse hand-blown integrally dyed glass vaso soplado a boca, pintado en masa
descente internationale international range gama internacional	1000 cycles garantis minimum 1000 wash cycles guaranteed 1000 ciclos de lavado garantizados

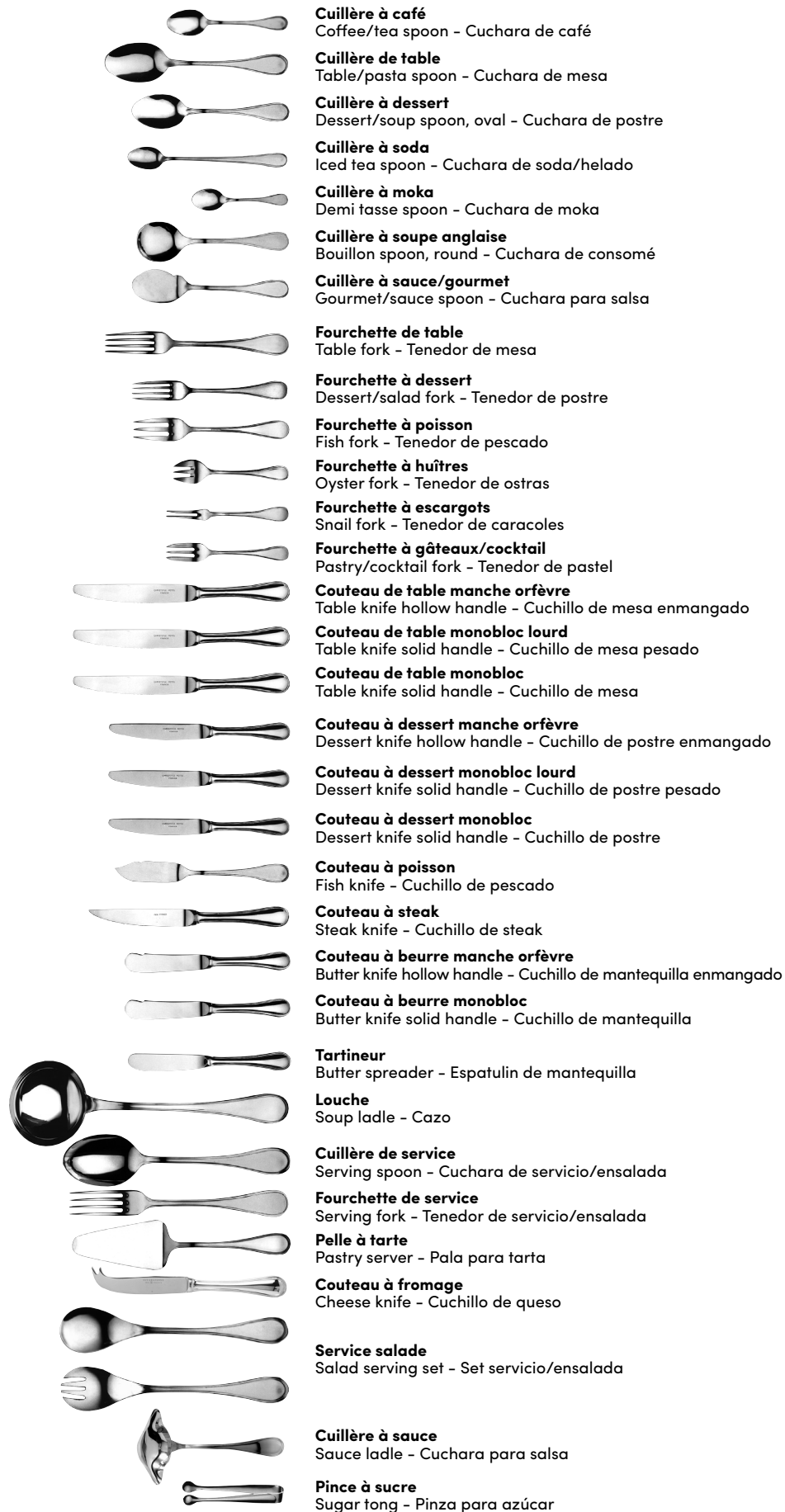



DEGRENNE

PARIS



COUVERTS
FLATWARE
CUBIERTOS



Absolu

	cm inch	MVM	CS		€
Fourchette de table Table fork Tenedor de mesa	20,2 7 ^{15/16}	12	144	126556	9,50
Couteau de table manche orfèvre lame unie Table knife hollow handle Cuchillo de mesa emangado hoja lisa	23 9 ^{1/16}	12	144	126565	19,95
Couteau de table manche orfèvre lame scie Table knife hollow handle serrated Cuchillo de mesa emangado hoja sierra	23 9 ^{1/16}	12	144	130332	19,95
Cuillère de table Table/pasta spoon Cuchara de mesa	20,5 8 ^{1/16}	12	144	126553	9,50
Cuillère à dessert Dessert/soup spoon, oval Cuchara de postre	18 7 ^{1/16}	12	144	126569	9,05
Fourchette à dessert Dessert/salad fork Tenedor de postre	18 7 ^{1/16}	12	144	126572	9,05
Couteau à dessert manche orfèvre lame unie Dessert knife hollow handle Cuchillo de postre emangado hoja lisa	20,5 8 ^{1/16}	12	144	126575	19,05
Couteau à beurre manche orfèvre Butter knife hollow handle Cuchillo de mantequilla emangado hoja lisa	18,8 7 ^{3/8}	12	144	154828	19,05

	cm inch	MVM	CS		€
Fourchette à poisson Fish fork Tenedor de pescado	18 7 ^{1/16}	12	144	126578	9,05
Couteau à poisson Fish knife Cuchillo de pescado	20,1 7 ^{15/16}	12	144	126581	9,05
Cuillère à café Coffee/tea spoon Cuchara de café	13,9 5 ^{1/2}	12	300	126559	5,75
Cuillère à moka Demi tasse spoon Cuchara de moka	11,1 4 ^{3/8}	12	300	155452	4,80
Fourchette de service Serving fork Tenedor de servicio/ensalada	24,8 9 ^{3/4}	1		126591	24,90
Cuillère de service Serving spoon Cuchara de servicio/ensalada	25 9 ^{13/16}	1		126589	24,90
Pelle à tarte manche orfèvre Pastry server hollow handle Pala para tarta emangado	24 9 ^{7/16}	1		126587	66,90
Louche à sauce Sauce ladle Cazo para salsa	17 6 ^{11/16}	1		126595	47,80



	cm inch	MVM	CS	€	
Fourchette de table Table fork Tenedor de mesa	20,9 8 ^{1/4}	12	144	163580	4,05
Couteau de table monobloc lame scie Table knife solid handle serrated Cuchillo de mesa hoja sierra	22,9 9	12	144	189969	5,30
Couteau à steak monobloc lame scie Steak knife solid handle serrated Cuchillo de steak hoja sierra	23,6 9 ^{5/16}	12	144	207189	5,30
Cuillère de table Table/pasta spoon Cuchara de mesa	21,1 8 ^{5/16}	12	144	163579	4,05
Cuillère à dessert Dessert/soup spoon, oval Cuchara de postre	19 7 ^{1/2}	12	144	164713	3,95
Fourchette à dessert Dessert/salad fork Tenedor de postre	18,9 7 ^{7/16}	12	144	164714	3,95
Couteau à dessert monobloc lame scie Dessert knife solid handle serrated Cuchillo de postre hoja sierra	20,6 8 ^{1/8}	12	144	210627	4,90
Couteau à beurre monobloc lame unie Butter knife solid handle Cuchillo de mantequilla hoja lisa	18,8 7 ^{3/8}	12	144	189971	3,50
Fourchette à poisson Fish fork Tenedor de pescado	18,9 7 ^{7/16}	12	144	164708	3,95
Couteau à poisson/gourmet Gourmet/Fish knife Cuchillo de pescado	21 8 ^{1/4}	12	144	164709	3,95
Cuillère à café Coffee/tea spoon Cuchara de café	14,3 5 ^{5/8}	12	300	163581	2,50

	cm inch	MVM	CS	€	
Cuillère à moka «touillette» Demi tasse spoon Cuchara de moka	11 4 ^{5/16}	12	300	164715	1,65
Cuillère à soda Iced tea spoon Cuchara de soda/helado	19 7 ^{1/2}	12	144	189973	2,90
Fourchette à gâteaux/cocktail Pastry/cocktail fork Tenedor de pastel	14,4 5 ^{11/16}	12	300	164705	2,90
Fourchette à huîtres Oyster fork Tenedor de ostras	14,1 5 ^{3/16}	12	300	189974	2,70
Fourchette/pique à escargots/cocktail Cocktail, snail fork Tenedor de caracoles/cocktail	10,8 4 ^{1/4}	12	300	162728	1,75
Curette à crustacé Seafood scraper Rasqueta para cangrejo	19,1 7 ^{1/2}	12	144	162730	2,70
Fourchette de service Serving fork Tenedor de servicio/ensalada	26,6 10 ^{1/2}	1		231218	15,50
Cuillère de service Serving spoon Cuchara de servicio/ensalada	26,6 10 ^{1/2}	1		231219	15,50
Pelle à tarte monobloc Pastry server solid handle Pala para tarta	25,2 9 ^{15/16}	1		231221	15,50
Louche Soup ladle Cazo	29 11 ^{7/16}	1		231220	28,90



Aquatic

	cm inch	MVM	CS		€
Fourchette de table Table fork Tenedor de mesa	20,1 7 ^{15/16}	12	144	126355	5,80
Couteau de table monobloc lame scie Table knife solid handle serrated Cuchillo de mesa hoja sierra	23,5 9 ^{1/4}	12	144	210731	8,25
Couteau à steak monobloc lame scie Steak knife solid handle serrated Cuchillo de steak hoja sierra	23,6 9 ^{5/16}	12	144	207189	5,30
Cuillère de table Table/pasta spoon Cuchara de mesa	20,3 8	12	144	126352	5,80
Cuillère à soupe anglaise Bouillon spoon, round Cuchara de consommé	17,9 7 ^{1/16}	12	300	140855	5,80
Cuillère à dessert Dessert/soup spoon, oval Cuchara de postre	17,8 7	12	144	126368	5,50
Fourchette à dessert Dessert/salad fork Tenedor de postre	17,7 6 ^{15/16}	12	144	126371	5,50
Couteau à dessert monobloc lame unie Dessert knife solid handle Cuchillo de postre hoja lisa	20,7 8 ^{1/8}	12	144	210732	7,50
Couteau à beurre monobloc lame unie Butter knife solid handle Cuchillo de mantequilla hoja lisa	18,9 7 ^{7/16}	12	144	189971	3,50
Fourchette à poisson Fish fork Tenedor de pescado	17,7 6 ^{15/16}	12	144	126377	5,50

	cm inch	MVM	CS		€
Couteau à poisson/gourmet Gourmet/fish knife Cuchillo de pescado	20,1 7 ^{15/16}	12	144	181181	5,50
Cuillère à café Coffee/tea spoon Cuchara de café	13,7 5 ^{3/8}	12	300	126358	3,50
Cuillère à moka Demi tasse spoon Cuchara de moka	11 4 ^{5/16}	12	300	140852	3,15
Cuillère à soda Iced tea spoon Cuchara de soda/helado	19 7 ^{1/2}	12	144	189973	2,90
Fourchette à gâteaux/cocktail Pastry/cocktail fork Tenedor de pastel	13,7 5 ^{3/8}	12	300	126383	4,15
Fourchette à huîtres Oyster fork Tenedor de ostras	14,1 5 ^{9/16}	12	300	189974	2,70
Fourchette de service Serving fork Tenedor de servicio/ensalada	26,6 10 ^{1/2}	1		231218	15,50
Cuillère de service Serving spoon Cuchara de servicio/ensalada	26,6 10 ^{1/2}	1		231219	15,50
Pelle à tarte monobloc Pastry server solid handle Pala para tarta	25,2 9 ^{15/16}	1		231221	15,50
Louche Soup ladle Cazo	29 11 ^{7/16}	1		231220	28,90



Astrée

	cm inch	MVM	CS		€
Fourchette de table Table fork Tenedor de mesa	20,7 8 ^{1/8}	12	144	153188	4,05
Couteau de table monobloc lame scie Table knife solid handle serrated Cuchillo de mesa hoja sierra	23,5 9 ^{1/4}	12	144	153196	5,30
Couteau à steak monobloc lame scie Steak knife solid handle serrated Cuchillo de steak hoja sierra	22,1 8 ^{11/16}	12	144	122418	4,50
Cuillère de table Table/pasta spoon Cuchara de mesa	20,7 8 ^{1/8}	12	144	153185	4,05
Cuillère à soupe anglaise Bouillon spoon, round Cuchara de consommé	18,3 7 ^{3/16}	12	144	184758	4,05
Cuillère à dessert Dessert/soup spoon, oval Cuchara de postre	18,6 7 ^{5/16}	12	144	153209	3,90
Fourchette à dessert Dessert/salad fork Tenedor de postre	18,6 7 ^{5/16}	12	144	153212	3,90
Couteau à dessert monobloc lame scie Dessert knife solid handle serrated Cuchillo de postre hoja sierra	21,1 8 ^{5/16}	12	144	153200	4,90
Couteau à beurre monobloc lame unie Butter knife solid handle Cuchillo de mantequilla hoja lisa	19,4 7 ^{5/8}	12	144	154612	3,50
Fourchette à poisson Fish fork Tenedor de pescado	18,6 7 ^{5/16}	12	144	153203	3,90
Couteau à poisson Fish knife Cuchillo de pescado	21,1 8 ^{5/16}	12	144	153206	3,90
Cuillère à café Coffee/tea spoon Cuchara de café	14,1 5 ^{3/16}	12	300	153191	2,50

	cm inch	MVM	CS		€
Cuillère à moka Demi tasse spoon Cuchara de moka	11,1 4 ^{3/8}	12	300	154609	2,00
Cuillère à soda Iced tea spoon Cuchara de soda/helado	19 7 ^{1/2}	12	144	190018	2,90
Fourchette à gâteaux/cocktail Pastry/cocktail fork Tenedor de pastel	13,9 5 ^{1/2}	12	300	197516	3,05
Fourchette à huîtres Oyster fork Tenedor de ostras	14,1 5 ^{3/16}	12	300	190424	2,70
Fourchette/pique à escargots/cocktail Cocktail, snail fork Tenedor de caracoles/cocktail	10,8 4 ^{1/4}	12	300	162728	1,75
Curette à crustacé Seafood scraper Rasqueta para cangrejo	19,1 7 ^{1/2}	12	144	162730	2,70
Fourchette de service Serving fork Tenedor de servicio/ensalada	26,6 10 ^{1/2}	1		197522	15,50
Cuillère de service Serving spoon Cuchara de servicio/ensalada	27 10 ^{5/8}	1		197523	15,50
Service à salade Salad serving set Set servicio de ensalada	30 11 ^{3/16}	1		197525	31,00
Pelle à tarte monobloc Pastry server solid handle Pala para tarta	25,1 9 ^{7/8}	1		197527	15,50
Louche Soup ladle Cazo	29,7 11 ^{11/16}	1		153193	28,90
Louche à sauce Sauce ladle Cazo para salsa	18,5 7 ^{5/16}	1		154606	16,50

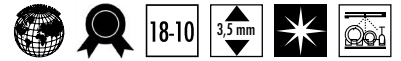

Astrée ciselé

	cm inch	MVM	CS		€		cm inch	MVM	CS		€
Fourchette de table Table fork Tenedor de mesa	20,7 8 ^{1/8}	12	144	153998	4,70	Couteau à poisson Fish knife Cuchillo de pescado	21,1 8 ^{5/16}	12	144	154561	4,45
Couteau de table monobloc lame scie Table knife solid handle serrated Cuchillo de mesa hoja sierra	23,5 9 ^{1/4}	12	144	154002	6,10	Cuillère à café Coffee/tea spoon Cuchara de café	14,1 5 ^{3/16}	12	300	154001	2,85
Couteau à steak monobloc lame scie Steak knife solid handle serrated Cuchillo de steak hoja sierra	22,8 9	12	144	199761	7,00	Cuillère à moka Demi tasse spoon Cuchara de moka	11,1 4 ^{3/8}	12	300	154577	2,40
Cuillère de table Table/pasta spoon Cuchara de mesa	20,7 8 ^{1/8}	12	144	153996	4,70	Cuillère à soda Iced tea spoon Cuchara de soda/helado	19 7 ^{1/2}	12	144	190016	3,30
Cuillère à soupe anglaise Bouillon spoon, round Cuchara de consommé	18,3 7 ^{3/16}	12	144	190015	4,70	Fourchette à gâteaux/cocktail Pastry/cocktail fork Tenedor de pastel	14 5 ^{1/2}	12	300	154547	3,30
Cuillère à dessert Dessert/soup spoon, oval Cuchara de postre	18,6 7 ^{5/16}	12	144	154571	4,45	Fourchette de service Serving fork Tenedor de servicio/ensalada	25,1 9 ^{7/8}	1		154563	15,50
Fourchette à dessert Dessert/salad fork Tenedor de postre	18,6 7 ^{5/16}	12	144	154574	4,45	Cuillère de service Serving spoon Cuchara de servicio/ensalada	25,5 10 ^{1/16}	1		154562	15,50
Couteau à dessert monobloc lame scie Dessert knife solid handle serrated Cuchillo de postre hoja sierra	21,1 8 ^{5/16}	12	144	154555	5,60	Service à salade Salad serving set Set servicio de ensalada	24,3 9 ^{9/16}	1		154566	31,00
Couteau à beurre monobloc lame unie Butter knife solid handle Cuchillo de mantequilla hoja lisa	19,4 7 ^{5/8}	12	144	154580	3,95	Pelle à tarte monobloc Pastry server solid handle Pala para tarta	25,3 9 ^{15/16}	1		154552	15,50
Fourchette à poisson Fish fork Tenedor de pescado	18,7 7 ^{3/8}	12	144	154558	4,45	Louche Soup ladle Cazo	29,7 11 ^{11/16}	1	12	154550	27,90

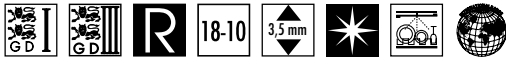

	cm inch	MVM	CS		€		cm inch	MVM	CS		€
Fourchette de table Table fork Tenedor de mesa	20,8 8 ^{3/16}	12	144	104485	5,30	Cuillère à sauce/gourmet Gourmet/sauce spoon Cuchara para salsa	17,9 7 ^{1/16}	12	144	145451	5,05
Couteau de table monobloc lourd lame scie Table knife solid handle serrated Cuchillo de mesa pesado hoja sierra	24,6 9 ^{11/16}	12	144	182466	6,85	Cuillère à café Coffee/tea spoon Cuchara de café	14 5 ^{1/2}	12	300	104561	3,20
Couteau de table manche orfèvre lame unie Table knife hollow handle Cuchillo de mesa emangado hoja lisa	24,6 9 ^{11/16}	12	144	161390	11,65	Cuillère à moka Demi tasse spoon Cuchara de moka	11 4 ^{5/16}	12	300	161398	2,65
Couteau de table manche orfèvre lame scie Table knife hollow handle serrated Cuchillo de mesa emangado hoja sierra	24,6 9 ^{11/16}	12	144	161391	11,65	Cuillère à soda Iced tea spoon Cuchara de soda/helado	18,2 7 ^{3/16}	12	144	124259	3,70
Couteau à steak manche orfèvre lame scie Steak knife hollow handle serrated Cuchillo de steak emangado hoja sierra	23,9 9 ^{7/16}	12	144	122759	11,70	Fourchette à gâteaux/cocktail Pastry/cocktail fork Tenedor de pastel	13,8 5 ^{5/16}	12	300	104480	3,75
Cuillère de table Table/pasta spoon Cuchara de mesa	20,8 8 ^{3/16}	12	144	104526	5,30	Fourchette à huîtres* Oyster fork Tenedor de ostras	12,9 5 ^{1/16}	12	300	123434	1,85
Cuillère à soupe anglaise* Bouillon spoon, round Cuchara de consommé	17,2 6 ^{3/4}	12	144	112695	2,85	Couteau à fromage manche orfèvre lame unie Cheese knife hollow handle Cuchillo queso emangado	19,3 7 ^{5/8}	1		189208	13,90
Cuillère à dessert Dessert/soup spoon, oval Cuchara de postre	18 7 ^{1/16}	12	144	104484	5,05	Fourchette de service Serving fork Tenedor de servicio/ensalada	24,8 9 ^{3/4}	1		195757	15,50
Fourchette à dessert Dessert/salad fork Tenedor de postre	17,8 7	12	144	104543	5,05	Cuillère de service Serving spoon Cuchara de servicio/ensalada	25 9 ^{13/16}	1		195755	15,50
Couteau à dessert monobloc lourd lame unie Dessert knife solid handle Cuchillo de postre pesado hoja lisa	20,5 8 ^{1/16}	12	144	182467	6,25	Fourchette à découper Carving fork Tenedor trinchante	24,8 9 ^{3/4}	1		195757	15,50
Couteau à dessert manche orfèvre lame unie Dessert knife hollow handle Cuchillo de postre emangado hoja lisa	20,5 8 ^{1/16}	12	144	161394	11,15	Couteau à découper manche orfèvre lame unie Carving knife hollow handle Cuchillo trinchante emangado	28,7 11 ^{5/16}	1		189511	67,90
Couteau à beurre lourd monobloc lame unie Butter knife solid handle Cuchillo de mantequilla pesado hoja lisa	18,7 7 ^{3/8}	12	96	190419	6,25	Service à salade Salad serving set Set servicio/ensalada	25,7 10 ^{1/8}	1		195750	31,00
Couteau à beurre manche orfèvre lame unie Butter knife hollow handle Cuchillo de mantequilla hoja lisa	18,7 7 ^{3/8}	12	144	122760	11,20	Pelle à tarte monobloc Pastry server solid handle Pala para tarta	24,9 9 ^{13/16}	1		195753	15,50
Fourchette à poisson* Fish fork Tenedor de pescado	17,8 7	12	144	108922	2,65	Louche Soup ladle Cazo	29,8 11 ^{3/4}	1		195762	29,50
Couteau à poisson* Fish knife Cuchillo de pescado	19,7 7 ^{3/4}	12	144	108924	2,65	Louche à sauce Sauce ladle Cazo para salsa	15,7 6 ^{13/16}	1		195759	25,50



Confidence

	cm inch	MVM	CS		€		cm inch	MVM	CS		€
Fourchette de table Table fork Tenedor de mesa	20,3 8	12	144	141094	2,75	Cuillère à moka Demi tasse spoon Cuchara de moka	11 4 ^{5/16}	12	300	109471	1,40
Couteau de table monobloc lame scie Table knife solid handle serrated Cuchillo de mesa hoja sierra	23,7 9 ^{5/16}	12	144	103857	3,60	Cuillère à soda* Iced tea spoon Cuchara de soda/helado	18,2 7 ^{3/16}	12	144	105800	3,70
Couteau à steak monobloc lame scie Steak knife solid handle serrated Cuchillo de steak hoja sierra	23,6 9 ^{5/16}	12	144	160433	3,60	Fourchette à gâteaux/cocktail Pastry/cocktail fork Tenedor de pastel	15 5 ^{7/8}	12	300	109472	1,95
Cuillère de table Table/pasta spoon Cuchara de mesa	20,4 8 ^{1/16}	12	144	141092	2,75	Fourchette à huîtres Oyster fork Tenedor de ostras	12,9 5 ^{1/16}	12	300	123440	1,80
Cuillère à soupe anglaise Bouillon spoon, round Cuchara de consommé	17,2 6 ^{3/4}	12	144	112692	2,75	Fourchette à escargots Snail fork Tenedor de caracoles	13,5 5 ^{5/16}	12	300	132782	1,65
Cuillère à dessert Dessert/soup spoon, oval Cuchara de postre	17,9 7 ^{1/16}	12	144	108232	2,65	Fourchette de service* Serving fork Tenedor de servicio/ensalada	24,8 9 ^{3/4}	1		002185	15,50
Fourchette à dessert Dessert/salad fork Tenedor de postre	17,8 7	12	144	108234	2,65	Cuillère de service* Serving spoon Cuchara de servicio/ensalada	25 9 ^{13/16}	1		002186	15,50
Couteau à dessert monobloc lame scie Dessert knife solid handle serrated Cuchillo de postre hoja sierra	20,6 8 ^{1/16}	12	144	210628	3,30	Service à salade* Salad serving set Set servicio de ensalada	25,8 10 ^{3/16}	1		040646	30,80
Fourchette à poisson Fish fork Tenedor de pescado	17,8 7	12	144	108918	2,65	Pelle à tarte monobloc* Pastry server solid handle Pala para tarta	24,9 9 ^{13/16}	1		083340	15,50
Couteau à poisson Fish knife Cuchillo de pescado	19,7 7 ^{3/4}	12	144	108920	2,65	Louche* Soup ladle Cazo	29,8 11 ^{3/4}	1	12	097717	29,50
Cuillère à café Coffee/tea spoon Cuchara de café	13,5 5 ^{5/16}	12	300	103564	1,70	Louche à sauce* Sauce ladle Cazo para salsa	15,7 6 ^{3/16}	1		002179	25,80

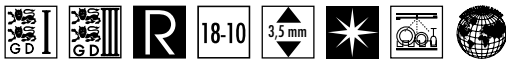

Florenzia

	cm inch	MVM	CS		€
Fourchette de table Table fork Tenedor de mesa	20,8 8 ^{3/16}	12	144	126077	6,65
Couteau de table monobloc lourd lame scie Table knife solid handle serrated Cuchillo de mesa pesado recto mango hoja sierra	24,6 9 ^{11/16}	12	144	190643	8,35
Couteau de table manche orfèvre manche droit lame scie Table knife hollow handle serrated Cuchillo de mesa enmangado recto mango hoja sierra	24,6 9 ^{11/16}	12	144	130140	13,90
Couteau à steak manche orfèvre manche droit lame scie Steak knife hollow handle serrated Cuchillo de steak enmangado recto mango hoja sierra	23,9 9 ^{7/16}	12	144	127654	13,90
Cuillère de table Table/pasta spoon Cuchara de mesa	20,8 8 ^{3/16}	12	144	126074	6,65
Cuillère à soupe anglaise Bouillon spoon, round Cuchara de consommé	17,4 6 ^{7/8}	12	144	127651	6,65
Cuillère à dessert Dessert/soup spoon, oval Cuchara de postre	18 7 ^{1/16}	12	144	126090	6,30
Fourchette à dessert Dessert/salad fork Tenedor de postre	17,8 7	12	144	126093	6,30
Couteau à dessert monobloc lourd lame unie Dessert knife solid handle Cuchillo de postre pesado hoja lisa	20,5 8 ^{1/16}	12	144	190644	7,70
Couteau à dessert manche orfèvre lame unie Dessert knife hollow handle Cuchillo de postre enmangado hoja lisa	20,5 8 ^{1/16}	12	144	126096	13,25

	cm inch	MVM	CS		€
Couteau à beurre lourd monobloc lame unie Butter knife solid handle Cuchillo de mantequilla pesado hoja lisa	18,7 7 ^{3/8}	12	96	190417	7,70
Couteau à beurre manche orfèvre lame unie Butter knife hollow handle Cuchillo de mantequilla enmangado hoja lisa	18,7 7 ^{3/8}	12	144	129344	13,25
Fourchette à poisson Fish fork Tenedor de pescado	17,7 6 ^{5/16}	12	144	126099	6,30
Couteau à poisson Fish knife Cuchillo de pescado	19,9 7 ^{13/16}	12	144	126102	6,30
Cuillère à sauce/gourmet Gourmet/sauce spoon Cuchara para salsa	17,9 7 ^{1/16}	12	144	129958	6,30
Cuillère à café Coffee/tea spoon Cuchara de café	14 5 ^{1/2}	12	300	126080	3,95
Cuillère à moka Demi tasse spoon Cuchara de moka	11 4 ^{5/16}	12	300	126105	3,35
Cuillère à soda Iced tea spoon Cuchara de soda/helado	18,2 7 ^{3/16}	12	144	130146	4,65
Fourchette à gâteaux/cocktail Pastry/cocktail fork Tenedor de pastel	13,8 5 ^{7/16}	12	144	126108	4,65
Fourchette à huîtres Oyster fork Tenedor de ostras	13 5 ^{1/8}	12	300	190418	4,35

PIECES DE SERVICE
SERVING PIECES
SET SERVICIO
VERLAINE
P. 39

Fuse NEW



	cm inch	MVM	CS		€		cm inch	MVM	CS		€
Fourchette de table Table fork Tenedor de mesa	21,5 8 ^{7/16}	12	144	236700	3,95	Couteau à dessert monobloc lame scie Dessert knife solid handle serrated Cuchillo de postre hoja sierra	19,2 7 ^{9/16}	12	144	236720	4,75
Couteau de table monobloc lame scie Table knife solid handle serrated Cuchillo de mesa hoja sierra	21,5 8 ^{7/16}	12	144	236702	5,15	Cuillère à café Coffee/tea spoon Cuchara de café	15 5 ^{7/8}	12	300	236703	2,40
Cuillère de table Table/pasta spoon Cuchara de mesa	21,5 8 ^{7/16}	12	144	236701	3,95	Cuillère à moka Demi tasse spoon Cuchara de moka	11 4 ^{5/16}	12	300	236722	2,10
Cuillère à soupe anglaise Bouillon spoon, round Cuchara de consommé	18,5 7 ^{5/16}	12	144	236726	3,95	Tartineur Butter spreader Espatulin de mantequilla	16,5 6 ^{1/2}	12	144	236727	3,40
Cuillère à dessert Dessert/soup spoon, oval Cuchara de postre	19,1 7 ^{1/2}	12	144	236721	3,80	Fourchette de service Serving fork Tenedor de servicio/ensalada	26 10 ^{1/4}	1		236724	10,30
Fourchette à dessert Dessert/salad fork Tenedor de postre	19,1 7 ^{1/2}	12	144	236719	3,80	Cuillère de service Serving spoon Cuchara de servicio/ensalada	26 10 ^{1/4}	1		236723	10,30



NEW Fuse martelé

	cm inch	MVM	CS		€		cm inch	MVM	CS		€
Fourchette de table Table fork Tenedor de mesa	21,5 8 ^{7/16}	12	144	236790	4,55	Cuillère à café Coffee/tea spoon Cuchara de café	15 5 ^{7/8}	12	300	236798	2,75
Couteau de table monobloc lame scie Table knife solid handle serrated Cuchillo de mesa hoja sierra	21,5 8 ^{7/16}	12	144	236791	5,90	Cuillère à moka Demi tasse spoon Cuchara de moka	11 4 ^{5/16}	12	300	236797	2,30
Cuillère de table Table/pasta spoon Cuchara de mesa	21,5 8 ^{7/16}	12	144	236789	4,55	Tartineur Butter spreader Espatulin de mantequilla	16,5 6 ^{1/2}	12	144	236804	3,95
Cuillère à soupe anglaise Bouillon spoon, round Cuchara de consommé	18,5 7 ^{5/16}	12	144	236802	4,55	Pic apéro Cocktail pic Pico de coctel	15 5 ^{7/8}	12	144	236806	3,20
Cuillère à dessert Dessert/soup spoon, oval Cuchara de postre	19,1 7 ^{1/2}	12	144	236796	4,30	Fourchette cocktail/escargot Cocktail/snail fork Tenedor caracoles/cocktail	15 5 ^{7/8}	12	144	236805	3,20
Fourchette à dessert Dessert/salad fork Tenedor de postre	19,1 7 ^{1/2}	12	144	236794	4,30	Fourchette de service Serving fork Tenedor de servicio/ensalada	26 10 ^{1/4}	1		236800	14,85
Couteau à dessert monobloc lame scie Dessert knife solid handle serrated Cuchillo de postre hoja sierra	19,2 7 ^{9/16}	12	144	236795	5,40	Cuillère de service Serving spoon Cuchara de servicio/ensalada	26 10 ^{1/4}	1		236799	14,85

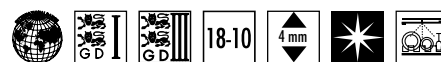

Guest

	cm inch	MVM	CS	€		cm inch	MVM	CS	€		
Fourchette de table Table fork Tenedor de mesa	21,3 8 ^{3/8}	12	144	197507	5,10	Couteau à poisson/gourmet Gourmet/fish knife Cuchillo de pescado	21,3 8 ^{3/8}	12	144	197515	4,85
Couteau de table monobloc lame scie Table knife solid handle serrated Cuchillo de mesa hoja sierra	23,2 9 ^{1/8}	12	144	197509	6,65	Cuillère à café Coffee/tea spoon Cuchara de café	14,3 5 ^{5/8}	12	300	197508	3,05
Couteau de table monobloc lame scie Table knife solid handle serrated Cuchillo de mesa hoja sierra	23,7 9 ^{5/16}	12	144	235481	6,65	Cuillère à moka Demi tasse spoon Cuchara de moka	11,7 4 ^{5/8}	12	300	197510	2,60
Couteau à steak monobloc lame scie Steak knife solid handle serrated Cuchillo de steak hoja sierra	23,2 9 ^{1/8}	12	144	197521	6,65	Cuillère à soda Iced tea spoon Cuchara de soda/helado	19 7 ^{1/2}	12	144	190018	2,90
Cuillère de table Table/pasta spoon Cuchara de mesa	21,6 8 ^{1/2}	12	144	197506	5,10	Fourchette à gâteaux Pastry fork Tenedor de pastel	13,9 5 ^{1/2}	12	300	197516	3,05
Cuillère à soupe anglaise Bouillon spoon, round Cuchara de consommé	18,5 7 ^{5/16}	12	144	197518	5,10	Fourchette à huîtres Oyster fork Tenedor de ostras	14,1 5 ^{9/16}	12	300	190424	2,70
Cuillère à dessert Dessert/soup spoon, oval Cuchara de postre	19,5 7 ^{11/16}	12	144	197512	4,85	Fourchette de service Serving fork Tenedor de servicio/ensalada	26,6 10 ^{1/2}	1		197522	15,50
Fourchette à dessert Dessert/salad fork Tenedor de postre	19,2 7 ^{9/16}	12	144	197511	4,85	Cuillère de service Serving spoon Cuchara de servicio/ensalada	27 10 ^{5/8}	1		197523	15,50
Couteau à dessert monobloc lame scie Dessert knife solid handle serrated Cuchillo de postre hoja sierra	20,9 8 ^{3/16}	12	144	210629	6,10	Service à salade Salad serving set Set servicio de ensalada	30 1 ^{13/16}	1		197525	31,00
Couteau à dessert monobloc lame scie Dessert knife solid handle serrated Cuchillo de postre hoja sierra	21,3 8 ^{3/8}	12	144	235482	6,10	Pelle à tarte monobloc Pastry server solid handle Pala para tarta	25,1 9 ^{7/8}	1		197527	15,50
Couteau à beurre monobloc lame unie Butter knife solid handle Cuchillo de mantequilla hoja lisa	19,3 7 ^{5/8}	12	144	197520	6,10	Louche Soup ladle Cazo	29,7 11 ^{11/16}	1	12	153193	28,90
Fourchette à poisson Fish fork Tenedor de pescado	19,2 7 ^{9/16}	12	144	197514	4,85	Louche à sauce Sauce ladle Cazo para salsa	18,5 7 ^{5/16}	1		154606	16,50



Guest cuivre

	cm inch	MVM	CS		€
Fourchette de table Table fork Tenedor de mesa	21,3 8 ^{3/8}	12	144	230848	14,30
Couteau de table monobloc lame scie Table knife solid handle serrated Cuchillo de mesa hoja sierra	23,2 9 ^{1/8}	12	144	230850	18,75
Cuillère de table Table/pasta spoon Cuchara de mesa	21,6 8 ^{1/2}	12	144	230849	14,30
Cuillère à dessert Dessert/soup spoon, oval Cuchara de postre	19,5 7 ^{11/16}	12	144	230854	13,65

	cm inch	MVM	CS		€
Fourchette à dessert Dessert/salad fork Tenedor de postre	19,2 7 ^{9/16}	12	144	230853	13,65
Couteau à dessert monobloc lame scie Dessert knife solid handle serrated Cuchillo de postre hoja sierra	20,9 8 ^{3/16}	12	144	230855	17,30
Cuillère à café Coffee/tea spoon Cuchara de café	14,3 5 ^{5/8}	12	300	230851	9,25
Cuillère à moka Demi tasse spoon Cuchara de moka	11,7 4 ^{5/8}	12	300	230852	8,70



Décor sur les 2 faces / On both sides

Guest star

	cm inch	MVM	CS		€		cm inch	MVM	CS		€
Fourchette de table Table fork Tenedor de mesa	21,3 8 ^{3/8}	12	144	223482	6,80	Couteau à poisson/gourmet Gourmet/fish knife Cuchillo de pescado	21,3 8 ^{3/8}	12	144	223488	6,45
Couteau de table monobloc lame scie Table knife solid handle serrated Cuchillo de mesa hoja sierra	23,2 9 ^{1/8}	12	144	202995	8,80	Cuillère à café Coffee/tea spoon Cuchara de café	14,3 5 ^{5/8}	12	300	223483	4,05
Couteau à steak monobloc lame scie Steak knife solid handle serrated Cuchillo de steak hoja sierra	23,2 9 ^{1/8}	12	144	203017	8,80	Cuillère à moka Demi tasse spoon Cuchara de moka	11,7 4 ^{5/8}	12	300	223484	3,40
Cuillère de table Table/pasta spoon Cuchara de mesa	21,6 8 ^{1/2}	12	144	223481	6,80	Cuillère à soda Iced tea spoon Cuchara de soda/helado	18,9 7 ^{7/16}	12	144	223492	4,75
Cuillère à soupe anglaise Bouillon spoon, round Cuchara de consommé	18,5 7 ^{5/16}	12	144	223491	6,80	Fourchette à gâteaux Pastry fork Tenedor de pastel	13,9 5 ^{1/2}	12	300	223489	4,75
Cuillère à dessert Dessert/soup spoon, oval Cuchara de postre	19,5 7 ^{11/16}	12	144	223486	6,45	Fourchette de service Serving fork Tenedor de servicio/ensalada	26,6 10 ^{1/2}	1		223493	20,50
Fourchette à dessert Dessert/salad fork Tenedor de postre	19,2 7 ^{9/16}	12	144	223485	6,45	Cuillère de service Serving spoon Cuchara de servicio/ensalada	27 10 ^{5/8}	1		223494	20,50
Couteau à dessert monobloc lame scie Dessert knife solid handle serrated Cuchillo de postre hoja sierra	20,9 8 ^{3/16}	12	144	210630	8,15	Service à salade Salad serving set Set servicio de ensalada	30 1 ^{13/16}	1		223496	41,00
Couteau à beurre monobloc lame unie Butter knife solid handle Cuchillo de mantequilla hoja lisa	19,3 7 ^{5/8}	12	144	203016	8,15	Pelle à tarte monobloc Pastry server solid handle Pala para tarta	25,1 9 ^{7/8}	1		223497	20,50
Fourchette à poisson Fish fork Tenedor de pescado	19,2 7 ^{9/16}	12	144	223487	6,45						



Guest vintage

	cm inch	MVM	CS		€		cm inch	MVM	CS		€
Fourchette de table Table fork Tenedor de mesa	21,3 8 ^{3/8}	12	144	217139	6,10	Couteau à dessert monobloc lame scie Dessert knife solid handle serrated Cuchillo de postre hoja sierra	20,9 8 ^{3/16}	12	144	217145	8,20
Couteau de table monobloc lame scie Table knife solid handle serrated Cuchillo de mesa hoja sierra	23,2 9 ^{1/8}	12	144	217140	8,85	Tartineur Butter spreader Espatulin de mantequilla	16 6 ^{5/16}	12	144	232307	6,85
Couteau à steak monobloc lame scie* Steak knife solid handle serrated Cuchillo de steak hoja sierra	23,2 9 ^{1/8}	12	144	230339	8,85	Fourchette à poisson* Fish fork Tenedor de pescado	19,2 7 ^{9/16}	12	144	230411	5,90
Cuillère de table Table/pasta spoon Cuchara de mesa	21,6 8 ^{1/2}	12	144	217141	6,10	Couteau à poisson/gourmet* Gourmet/fish knife Cuchillo de pescado	21,3 8 ^{3/8}	12	144	230412	5,90
Cuillère à dessert Dessert/soup spoon, oval Cuchara de postre	19,5 7 ^{11/16}	12	144	217143	5,90	Cuillère à café Coffee/tea spoon Cuchara de café	14,3 5 ^{5/8}	12	300	217142	4,00
Fourchette à dessert Dessert/salad fork Tenedor de postre	19,2 7 ^{9/16}	12	144	217144	5,90	Cuillère à moka Demi tasse spoon Cuchara de moka	11,7 4 ^{5/8}	12	300	217146	3,75

*Disponible sur commande / Available upon order receipt/ Disponible bajo pedido



L'E Starck®

	cm inch	MVM	CS	€		cm inch	MVM	CS	€		
Fourchette de table Table fork Tenedor de mesa	20,5 8 ^{1/16}	12	144	233011	5,10	Couteau à dessert monobloc à bout rond lame scie Dessert knife solid handle rounded blade Cuchillo de postre hoja lisa	20,9 8 ^{1/4}	12	144	233019	6,10
Couteau de table monobloc à bout pointu lame scie Table knife solid handle pointed blade serrated Cuchillo de mesa hoja sierra	23,3 9 ^{3/16}	12	144	233013	6,65	Couteau à beurre monobloc lame unie Butter knife solid handle Cuchillo de mantequilla hoja lisa	17,5 6 ^{7/8}	12	96	233023	5,10
Couteau de table monobloc à bout rond lame scie Table knife solid handle rounded blade serrated Cuchillo de mesa hoja sierra	23,3 9 ^{3/16}	12	144	233014	6,65	Cuillère gourmet Gourmet spoon Cuchara para salsa	18,5 7 ^{5/16}	12	144	233021	4,85
Couteau de table manche orfèvre lame unie Table knife hollow handle Cuchillo de mesa enmangado hoja lisa	23,3 9 ^{3/16}	12	144	229520	13,90	Cuillère à café Coffee/tea spoon Cuchara de café	13,9 5 ^{1/2}	12	300	233015	3,05
Cuillère de table Table/pasta spoon Cuchara de mesa	20,5 8 ^{1/16}	12	144	233012	5,10	Cuillère à moka Demi tasse spoon Cuchara de moka	11,7 4 ^{5/8}	12	300	233016	2,60
Cuillère à soupe anglaise Bouillon spoon, round Cuchara de consommé	18,5 7 ^{5/16}	12	144	233022	5,10	Fourchette à gâteaux/cocktail Pastry/cocktail fork Tenedor de pastel	13,9 5 ^{1/2}	12	144	233020	3,60
Cuillère à dessert Dessert/soup spoon Cuchara de postre	18,5 7 ^{5/16}	12	144	233018	4,85	Fourchette de service Serving fork Tenedor de servicio/ensalada	26,3 10 ^{3/8}	1		233024	15,50
Fourchette à dessert Dessert/salad fork Tenedor de postre	18,5 7 ^{5/16}	12	144	233017	4,85	Cuillère de service Serving spoon Cuchara de servicio/ensalada	26,3 10 ^{3/8}	1		233025	15,50



	cm inch	MVM	CS		€		cm inch	MVM	CS		€
Fourchette de table Table fork Tenedor de mesa	20,9 8 ^{3/16}	12	144	105021	6,25	Couteau à dessert manche orfèvre lame unie Dessert knife hollow handle Cuchillo de postre enmangado hoja lisa	20,6 8 ^{1/8}	12	144	104989	12,45
Couteau de table monobloc lourd lame scie Table knife solid handle serrated Cuchillo de mesa pesado hoja sierra	24,8 9 ^{3/4}	12	96	190415	7,85	Couteau à beurre monobloc lourd lame unie Butter knife solid handle Cuchillo de mantequilla pesado hoja lisa	19,7 7 ^{3/4}	12	144	190414	7,15
Couteau de table manche orfèvre lame scie Table knife hollow handle serrated Cuchillo de mesa enmangado hoja sierra	24,7 9 ^{3/4}	12	144	105006	13,05	Couteau à beurre manche orfèvre lame unie Butter knife hollow handle Cuchillo de mantequilla enmangado hoja lisa	18,9 7 ^{7/16}	12	144	016394	12,45
Couteau à steak manche orfèvre lame scie Steak knife hollow handle serrated Cuchillo de steak enmangado hoja sierra	23,8 9 ^{3/8}	12	144	122746	13,05	Fourchette à poisson Fish fork Tenedor de pescado	17,9 7 ^{1/16}	12	144	104994	5,90
Cuillère de table Table/pasta spoon Cuchara de mesa	21,1 8 ^{5/16}	12	144	104988	6,25	Couteau à poisson Fish knife Cuchillo de pescado	20 7 ^{7/8}	12	144	104995	5,90
Cuillère à soupe anglaise Bouillon spoon, round Cuchara de consommé	17,4 6 ^{7/8}	12	144	104975	6,25	Cuillère à sauce/gourmet Gourmet/sauce spoon Cuchara para salsa	18 7 ^{1/16}	12	144	104977	5,90
Cuillère à dessert Dessert/soup spoon, oval Cuchara de postre	18 7 ^{1/16}	12	144	104985	5,90	Cuillère à café Coffee/tea spoon Cuchara de café	14,1 5 ^{9/16}	12	300	104986	3,75
Fourchette à dessert Dessert/salad fork Tenedor de postre	17,9 7 ^{1/16}	12	144	105013	5,90	Cuillère à moka Demi tasse spoon Cuchara de moka	11,2 4 ^{7/16}	12	300	104993	3,15
Couteau à dessert monobloc lourd lame unie Dessert knife solid handle Cuchillo de postre pesado hoja lisa	21,3 8 ^{3/8}	12	96	190416	7,15	Fourchette à gâteaux/cocktail Pastry/cocktail fork Tenedor de pastel	13,9 5 ^{1/2}	12	300	105012	4,40



Marquise

	cm inch	MVM	CS		€		cm inch	MVM	CS		€
Fourchette de table Table fork Tenedor de mesa	20,8 8 ^{3/16}	12	144	182968	6,65	Couteau à poisson Fish knife Cuchillo de pescado	19,9 7 ^{13/16}	12	144	182973	6,30
Couteau de table manche orfèvre lame scie Table knife hollow handle serrated Cuchillo de mesa emangado hoja sierra	24,6 9 ^{11/16}	12	144	182970	13,90	Cuillère à sauce/gourmet Gourmet/sauce spoon Cuchara para salsa	17,9 7 ^{1/16}	12	144	186277	6,30
Couteau à steak manche orfèvre lame scie Steak knife hollow handle serrated Cuchillo de steak emangado hoja sierra	23,9 9 ^{7/16}	12	144	186278	13,90	Cuillère à café Coffee/tea spoon Cuchara de café	14 5 ^{1/2}	12	300	182969	3,95
Cuillère de table Table/pasta spoon Cuchara de mesa	20,8 8 ^{3/16}	12	144	182967	6,65	Cuillère à moka Demi tasse spoon Cuchara de moka	11 4 ^{5/16}	12	300	182976	3,35
Cuillère à soupe anglaise Bouillon spoon, round Cuchara de consommé	17,4 6 ^{7/8}	12	144	186276	6,65	Cuillère à soda Iced tea spoon Cuchara de soda/helado	18,2 7 ^{3/16}	12	240	186275	4,65
Cuillère à dessert Dessert/soup spoon, oval Cuchara de postre	18 7 ^{1/16}	12	144	182974	6,30	Fourchette à gâteaux/cocktail Pastry/cocktail fork Tenedor de pastel	13,8 5 ^{7/16}	12	300	186274	4,65
Fourchette à dessert Dessert/salad fork Tenedor de postre	17,8 7	12	144	182975	6,30	Fourchette à huîtres Oyster fork Tenedor de ostras	13 5 ^{1/8}	12	300	190681	4,35
Couteau à dessert manche orfèvre lame unie Dessert knife hollow handle Cuchillo de postre emangado hoja lisa	20,5 8 ^{1/16}	12	144	182971	13,25	Fourchette de service Serving fork Tenedor de servicio/ensalada	24,8 9 ^{3/4}	1		183803	17,90
Couteau à beurre manche orfèvre lame unie Butter knife hollow handle Cuchillo de mantequilla hoja lisa	18,7 7 ^{3/8}	12	144	186279	13,25	Cuillère de service Serving spoon Cuchara de servicio/ensalada	25 9 ^{13/16}	1		183802	17,90
Fourchette à poisson Fish fork Tenedor de pescado	17,7 6 ^{15/16}	12	144	182972	6,30						



Mikado

	cm inch	MVM	CS	€	
Fourchette de table Table fork Tenedor de mesa	20,3 8	12	144	141089	2,75
Couteau de table monobloc lourd lame scie Table knife solid handle serrated Cuchillo de mesa pesado hoja sierra	24,4 9 ^{5/8}	12	144	113017	4,15
Couteau à steak monobloc lame scie Steak knife solid handle serrated Cuchillo de steak hoja sierra	23,2 9 ^{1/8}	12	144	160427	3,60
Cuillère de table Table/pasta spoon Cuchara de mesa	20,4 8 ^{1/16}	12	144	141086	2,75
Cuillère à soupe anglaise Bouillon spoon, round Cuchara de consommé	17,2 6 ^{3/4}	12	144	112695	2,85
Cuillère à dessert Dessert/soup spoon, oval Cuchara de postre	17,9 7 ^{1/16}	12	144	108236	2,65
Fourchette à dessert Dessert/salad fork Tenedor de postre	17,8 7	12	144	108238	2,65
Couteau à dessert monobloc lourd lame unie Dessert knife solid handle Cuchillo de postre pesado hoja lisa	21 8 ^{1/4}	12	144	113019	3,85
Couteau à beurre monobloc lame unie Butter knife solid handle Cuchillo de mantequilla hoja lisa	18,9 7 ^{7/16}	12	144	189971	3,50
Fourchette à poisson Fish fork Tenedor de pescado	17,8 7	12	144	108922	2,65
Couteau à poisson Fish knife Cuchillo de pescado	19,7 7 ^{3/4}	12	144	108924	2,65

	cm inch	MVM	CS	€	
Cuillère à café Coffee/tea spoon Cuchara de café	13,5 5 ^{5/16}	12	300	103550	1,70
Cuillère à moka Demi tasse spoon Cuchara de moka	11 4 ^{5/16}	12	300	109465	1,40
Cuillère à soda* Iced tea spoon Cuchara de soda/helado	18,2 7 ^{3/16}	12	144	124259	3,70
Fourchette à gâteaux/cocktail Pastry/cocktail fork Tenedor de pastel	15 5 ^{7/8}	12	300	109466	1,95
Fourchette à huîtres Oyster fork Tenedor de ostras	12,9 5 ^{1/16}	12	300	123434	1,85
Fourchette de service* Serving fork Tenedor de servicio/ensalada	24,8 9 ^{3/4}	1		195757	15,50
Cuillère de service* Serving spoon Cuchara de servicio/ensalada	25 9 ^{13/16}	1		195755	15,50
Service à salade* Salad serving set Set servicio de ensalada	25,7 10 ^{1/8}	1		195750	31,00
Pelle à tarte monobloc* Pastry server solid handle Pala para tarta	24,9 9 ^{13/16}	1		195753	15,50
Louche* Soup ladle Cazo	29,8 11 ^{3/4}	1		195762	29,50
Louche à sauce* Sauce ladle Cazo para salsa	15,7 6 ^{3/16}	1		195759	25,50

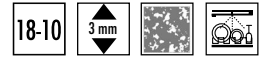

Mikado vintage

	cm inch	MVM	CS		€		cm inch	MVM	CS		€
Fourchette de table Table fork Tenedor de mesa	20,3 8	12	144	230285	3,20	Fourchette à dessert Dessert/salad fork Tenedor de postre	17,8 7	12	144	230290	3,05
Couteau de table monobloc lourd lame scie Table knife solid handle serrated Cuchillo de mesa pesado hoja sierra	24,4 9 ^{5/8}	12	144	230287	4,80	Couteau à dessert monobloc lourd lame unie Dessert knife solid handle Cuchillo de postre pesado hoja lisa	21 8 ^{1/4}	12	144	230292	4,45
Couteau à steak monobloc lame scie Steak knife solid handle serrated Cuchillo de steak hoja sierra	23,2 9 ^{1/8}	12	144	230293	4,05	Couteau à beurre monobloc lame unie Butter knife solid handle Cuchillo de mantequilla hoja lisa	18,9 7 ^{7/16}	12	144	232308	4,45
Cuillère de table Table/pasta spoon Cuchara de mesa	20,4 8 ^{1/16}	12	144	230286	3,20	Cuillère à café Coffee/tea spoon Cuchara de café	13,5 5 ^{5/16}	12	300	230288	1,90
Cuillère à dessert Dessert/soup spoon, oval Cuchara de postre	17,9 7 ^{1/16}	12	144	230291	3,05	Cuillère à moka Demi tasse spoon Cuchara de moka	11 4 ^{5/16}	12	300	230289	1,75



Milady

	cm inch	MVM	CS		€
Fourchette de table Table fork Tenedor de mesa	20,8 8 ^{3/16}	12	144	127442	6,65
Couteau de table monobloc lourd lame scie Table knife solid handle serrated Cuchillo de mesa pesado hoja sierra	24,6 9 ^{11/16}	12	144	226578	8,35
Couteau de table manche orfèvre lame scie Table knife hollow handle serrated Cuchillo de mesa emangado hoja sierra	24,6 9 ^{11/16}	12	144	139158	13,90
Couteau à steak manche orfèvre lame scie Steak knife hollow handle serrated Cuchillo de steak emangado hoja sierra	23,9 9 ^{7/16}	12	144	128841	13,90
Cuillère de table Table/pasta spoon Cuchara de mesa	20,8 8 ^{3/16}	12	144	127439	6,65
Cuillère à soupe anglaise Bouillon spoon, round Cuchara de consommé	17,4 6 ^{7/8}	12	144	130273	6,65
Cuillère à dessert Dessert/soup spoon, oval Cuchara de postre	18 7 ^{1/16}	12	144	127464	6,30
Fourchette à dessert Dessert/salad fork Tenedor de postre	17,8 7	12	144	127467	6,30
Couteau à dessert monobloc lourd lame unie Dessert knife solid handle Cuchillo de postre pesado hoja lisa	21,1 8 ^{5/16}	12	144	226579	7,65
Couteau à dessert manche orfèvre lame unie Dessert knife hollow handle Cuchillo de postre emangado hoja lisa	20,5 8 ^{1/16}	12	144	127470	13,25

	cm inch	MVM	CS		€
Couteau à beurre monobloc lourd lame unie Butter knife solid handle Cuchillo de mantequilla pesado hoja lisa	19 7 ^{1/2}	12	144	226580	7,65
Couteau à beurre manche orfèvre lame unie Butter knife solid handle Cuchillo de mantequilla emangado hoja lisa	18,7 7 ^{3/8}	12	144	122769	13,25
Fourchette à poisson Fish fork Tenedor de pescado	17,7 6 ^{15/16}	12	144	127473	6,30
Couteau à poisson Fish knife Cuchillo de pescado	19,9 7 ^{13/16}	12	144	127477	6,30
Cuillère à sauce/gourmet Gourmet/sauce spoon Cuchara para salsa	17,9 7 ^{1/16}	12	144	130542	6,30
Cuillère à café Coffee/tea spoon Cuchara de café	14 5 ^{1/2}	12	300	127455	3,95
Cuillère à moka Demi tasse spoon Cuchara de moka	11 4 ^{5/16}	12	300	127479	3,35
Fourchette à gâteaux/cocktail Pastry/cocktail fork Tenedor de pastel	13,8 5 ^{7/16}	12	300	127482	4,65
Fourchette à huîtres Oyster fork Tenedor de ostras	13 5 ^{1/8}	12	300	130266	4,35

PIECES DE SERVICE
SERVING PIECES
SET SERVICIO
VERLAINE
P. 39



Mirage

	cm inch	MVM	CS		€		cm inch	MVM	CS		€
Fourchette de table Table fork Tenedor de mesa	21 8 ^{1/4}	12	144	226167	4,05	Cuillère à moka Demi tasse spoon Cuchara de moka	11,6 4 ^{9/16}	12	300	226170	2,00
1 Couteau de table monobloc lame scie n°1 Table knife solid handle serrated n°1 Cuchillo de mesa hoja sierra n°1	22,8 9	12	144	226177	7,95	Cuillère à soda Iced tea spoon Cuchara de soda/helado	19 7 ^{1/2}	12	144	226175	2,90
2 Couteau de table monobloc lame scie n°2 Table knife solid handle serrated n°2 Cuchillo de mesa hoja sierra n°2	22,8 9	12	144	226176	5,30	Fourchette à gâteaux/cocktail Pastry/cocktail fork Tenedor de pastel	14,5 5 ^{11/16}	12	300	226174	2,90
Cuillère de table Table/pasta spoon Cuchara de mesa	21 8 ^{1/4}	12	144	226168	4,05	Fourchette à huîtres Oyster fork Tenedor de ostras	14,1 5 ^{5/16}	12	300	190424	2,70
Cuillère à dessert Dessert/soup spoon, oval Cuchara de postre	18,9 7 ^{7/16}	12	144	226172	3,90	Fourchette de service Serving fork Tenedor de servicio/ensalada	26,6 10 ^{1/2}	1		197522	15,50
Fourchette à dessert Dessert/salad fork Tenedor de postre	18,9 7 ^{7/16}	12	144	226171	3,90	Cuillère de service Serving spoon Cuchara de servicio/ensalada	27 10 ^{5/8}	1		197523	15,50
1 Couteau à dessert monobloc lame unie n°1 Dessert knife solid handle n°1 Cuchillo de postre hoja lisa n°1	20,5 8 ^{1/16}	12	144	226179	7,15	Service à salade Salad serving set Set servicio de ensalada	30 1 ^{13/16}	1		197525	31,00
2 Couteau à dessert monobloc lame unie n°2 Dessert knife solid handle n°2 Cuchillo de postre hoja lisa n°2	20,5 8 ^{1/16}	12	144	226178	4,90	Pelle à tarte monobloc Pastry server solid handle Pala para tarta	25,1 9 ^{7/8}	1		197527	15,50
Fourchette à poisson Fish fork Tenedor de pescado	18,9 7 ^{7/16}	12	144	226171	3,90	Louche Soup ladle Cazo	29,7 11 ^{11/16}	1		153193	28,90
Couteau à poisson/gourmet Gourmet/fish knife Cuchillo de pescado	21 8 ^{1/4}	12	144	226173	3,90	Louche à sauce Sauce ladle Cazo para salsa	18,5 7 ^{5/16}	1		154606	16,50
Cuillère à café Coffee/tea spoon Cuchara de café	14,5 5 ^{11/16}	12	300	226169	2,45						



	cm inch	MVM	CS		€
Fourchette de table Table fork Tenedor de mesa	20,8 8 ^{3/16}	12	144	105278	6,65
Couteau de table manche orfèvre lame scie Table knife hollow handle serrated Cuchillo de mesa enmangado hoja sierra	24,6 9 ^{11/16}	12	144	105274	13,90
Cuillère de table Table/pasta spoon Cuchara de mesa	20,8 8 ^{3/16}	12	144	105310	6,65
Cuillère à dessert Dessert/soup spoon, oval Cuchara de postre	18 7 ^{1/16}	12	144	105294	6,30

	cm inch	MVM	CS		€
Fourchette à dessert Dessert/salad fork Tenedor de postre	17,8 7	12	144	105290	6,30
Couteau à dessert manche orfèvre lame unie Dessert knife hollow handle Cuchillo de postre enmangado hoja lisa	20,5 8 ^{1/16}	12	144	105305	13,25
Cuillère à café Coffee/tea spoon Cuchara de café	14 5 ^{1/2}	12	300	105303	3,95
Cuillère à moka Demi tasse spoon Cuchara de moka	11 4 ^{5/16}	12	300	105293	3,35



Normandy

	cm inch	MVM	CS		€		cm inch	MVM	CS		€
Fourchette de table Table fork Tenedor de mesa	20,3 8	12	144	232963	6,65	Fourchette à dessert Dessert fork Tenedor de postre	18,3 7 ^{3/16}	12	144	234656	6,30
Couteau de table monobloc lame scie Table knife solid handle serrated Cuchillo de mesa hoja sierra	24 9 ^{7/16}	12	144	232966	8,35	Couteau à dessert monobloc lame unie Dessert knife solid handle Cuchillo de postre hoja lisa	21,5 8 ^{7/16}	12	144	234657	7,70
Cuillère de table Table/pasta spoon Cuchara de mesa	20,3 8	12	144	232964	6,65	Couteau à beurre monobloc lame unie Butter knife solid handle Cuchillo de mantequilla hoja lisa	18,5 7 ^{5/16}	12	144	234658	7,70
Cuillère à soupe anglaise Bouillon spoon Cuchara de consommé	17,6 6 ^{15/16}	12	144	234654	6,65	Cuillère à café Coffee/tea spoon Cuchara de café	14 5 ^{1/2}	12	300	232965	3,95
Cuillère à dessert Dessert spoon Cuchara de postre	18,2 7 ^{3/16}	12	144	234659	6,30	Cuillère à moka Demi tasse spoon Cuchara de moka	11,1 4 ^{3/8}	12	300	234660	3,35
Cuillère gourmet Gourmet spoon Cuchara Gourmet	18,2 7 ^{3/16}	12	144	234655	6,30	Fourchette à gâteaux/cocktail Pastry/cocktail fork Tenedor de pastel	14 5 ^{1/2}	12	300	234661	4,65



Norway

	cm inch	MVM	CS		€
Fourchette de table Table fork Tenedor de mesa	20,4 8 ^{1/16}	12	144	111894	3,40
Couteau de table monobloc lame scie Table knife solid handle serrated Cuchillo de mesa hoja sierra	23 9 ^{1/16}	12	144	111921	4,45
Cuillère de table Table/pasta spoon Cuchara de mesa	20,4 8 ^{1/16}	12	144	111891	3,40
Cuillère à dessert Dessert/soup spoon, oval Cuchara de postre	18 7 ^{1/16}	12	144	111904	3,25

	cm inch	MVM	CS		€
Fourchette à dessert Dessert/salad fork Tenedor de postre	18 7 ^{1/16}	12	144	111907	3,25
Couteau à dessert monobloc lame scie Dessert knife solid handle serrated Cuchillo de postre hoja sierra	20,3 8	12	144	210631	4,10
Cuillère à café Coffee/tea spoon Cuchara de café	13,6 5 ^{3/8}	12	300	111897	2,05
Cuillère à moka Demi tasse spoon Cuchara de moka	11 4 ^{5/16}	12	300	114437	1,70



Petit Gourmet

Miroir - mirror

	cm inch	MVM	CS		€
Cuillère à café Coffee/tea spoon Cuchara de café	13,2 5 ^{3/16}	12	300	207256	3,55
Fourchette à dessert Dessert/salad fork Tenedor de postre	16,5 6 ^{1/2}	12	144	207257	4,95

	cm inch	MVM	CS		€
Couteau à dessert monobloc lame unie Dessert knife solid handle Cuchillo de postre hoja lisa	17,7 6 ^{15/16}	12	144	207259	6,45
Cuillère à dessert Dessert/soup spoon, oval Cuchara de postre	16,5 6 ^{1/2}	12	144	207258	4,95

Métal argenté silver plated - plateado

	cm inch	MVM	CS		€
Cuillère à café Coffee/tea spoon Cuchara de café	13,2 5 ^{3/16}	12	300	207537	12,45
Fourchette à dessert Dessert/salad fork Tenedor de postre	16,5 6 ^{1/2}	12	144	207538	15,85

	cm inch	MVM	CS		€
Couteau à dessert monobloc lame unie Dessert knife solid handle Cuchillo de postre hoja lisa	17,7 6 ^{15/16}	12	144	207540	17,30
Cuillère à dessert Dessert/soup spoon, oval Cuchara de postre	16,5 6 ^{1/2}	12	144	207539	15,85

Pièces complémentaires

Cuillère à soda

Iced tea spoon - Cuchara de soda

	cm - inch	MVM	CS		€
Aloa - Aquatic	19 - 7 ^{1/2}	12	144	189973	2,90
Astrée - Guest - Serenity - Solstice - XY	19 - 7 ^{1/2}	12	144	190018	2,90
Astrée ciselé	19 - 7 ^{1/2}	12	144	190016	3,30
Blois - Mikado	18,2 - 7 ^{3/16}	12	144	124259	3,70
Confidence - Verlaine	18,2 - 7 ^{3/16}	12	144	105800	3,70
Florenzia	18,2 - 7 ^{3/16}	12	144	130146	4,65



	cm - inch	MVM	CS		€
Guest star	18,9 - 7 ^{7/16}	12	144	223492	4,75
Marquise	18,2 - 7 ^{3/16}	12	144	186275	4,65
Mirage	19 - 7 ^{1/2}	12	144	226175	2,90
Squadro	18,8 - 7 ^{3/8}	12	144	199169	4,65
XY black miroir	19 - 7 ^{1/2}	12	144	196674	12,75

Fourchette à huîtres

Oyster fork - Tenedor de ostras

	cm - inch	MVM	CS		€
Aloa - Aquatic	14,1 - 5 ^{9/16}	12	300	189974	2,70
Astrée - Guest - Mirage - Serenity - Solstice	14,1 - 5 ^{9/16}	12	300	190424	2,70
Blois - Mikado	12,9 - 5 ^{1/16}	12	300	123434	1,85
Confidence - Verlaine	12,9 - 5 ^{1/16}	12	300	123440	1,80
Florenzia	13 - 5 ^{1/8}	12	300	190418	4,35



	cm - inch	MVM	CS		€
Marquise	13 - 5 ^{1/8}	12	300	190681	4,35
Milady	13 - 5 ^{1/8}	12	300	130266	4,35
Vieux paris satiné	13,2 - 5 ^{3/16}	12	300	105803	1,55
XY black miroir	14,1 - 5 ^{9/16}	12	300	196014	12,05

Crustacés

Seafood - Crustáceos

	cm inch	MVM	CS		€
Curette à crustacés Seafood scraper Rasqueta para crustáceos	19,1 7 ^{1/2}	12	144	162730	2,70
Pince à crustacés Seafood cracker Tenacillas para crustáceos	16,5 6 ^{1/2}	1	84	184492	11,90



	cm inch	MVM	CS		€
Pince à homard Lobster cracker Tenacillas para bogavante	18,5 7 ^{5/16}	1	84	204497	50,95
Pince à homard Lobster cracker Tenacillas para bogavante	18,5 7 ^{5/16}	1	84	101493	103,00

Pièces complémentaires

Couteaux à steak Steak knife - Cuchillo de steak



cm
inch MVM CS €

Couteau à steak monobloc lame scie Steak knife solid handle serrated Cuchillo de steak hoja sierra	23,5 9 ^{1/4}	12	144	159451	7,40
--	--------------------------	----	-----	--------	------



cm
inch MVM CS €

Couteau à steak monobloc lame scie Steak knife solid handle serrated Cuchillo de steak hoja sierra	22,1 8 ^{11/16}	12	144	122418	4,50
--	----------------------------	----	-----	--------	------

Couteaux à beurre Butter knife - Cuchillo de mantequilla



cm
inch MVM CS €

Couteau à beurre monobloc lame unie Butter knife solid handle Cuchillo de mantequilla hoja lisa	19,4 7 ^{5/8}	12	144	154612	3,50
---	--------------------------	----	-----	--------	------



cm
inch MVM CS €

Couteau à beurre monobloc lame unie Butter knife solid handle Cuchillo de mantequilla hoja lisa	18,9 7 ^{7/16}	12	144	189971	3,50
---	---------------------------	----	-----	--------	------

Fourchette à escargots Snail fork - Tenedor de caracoles



cm - inch MVM CS €

Aloa - Astrée miroir - Modulo	10,8 - 4 ^{1/4}	12	300	162728	1,75
Confidence - Verlainé	13,5 - 5 ^{5/16}	12 <td>300</td> <td>132782</td> <td>1,65</td>	300	132782	1,65



cm
inch MVM CS €

Pince à escargots Snail tong Pinzas caracoles	16 6 ^{5/16}	1	84	004013	3,45
---	-------------------------	---	----	--------	------

Pinces Tong - Pan



cm
inch MVM CS €

Pince à pain Bread tong Pinzas pan	23 9 ^{1/16}	1	84	204498	18,40
Pince à pain Bread tong Pinzas pan	23 9 ^{1/16}	1	84	101492	51,35



cm
inch MVM CS €

Pince à servir Serving tong Pinzas para servir	29,5 11 ^{5/8}	1	84	204499	26,90
Pince à servir Serving tong Pinzas para servir	29,5 11 ^{5/8}	1	84	184355	53,15

Ciseaux Cissors - Pinzas



cm
inch MVM CS €

Ciseaux à gâteaux Pastry cissors/tong Pinzas para pasteles	20 7 ^{7/8}	1	84	204496	50,40
Ciseaux à gâteaux Pastry cissors/tong Pinzas para pasteles	20 7 ^{7/8}	1	84	101494	80,50



cm
inch MVM CS €

Cuillère à agrumes Citrus fruits spoon Cuchara para pomelo	15,3 6	12	300	162724	2,70
--	-----------	----	-----	--------	------



Quartz

Carbone - Carbon - Carbono

	cm inch	MVM	CS		€
Fourchette de table Table fork Tenedor de mesa	21,6 8 ^{1/2}	12	144	205883	3,60
Couteau à steak monobloc lame scie Steak knife solid handle serrated Cuchillo de steak hoja sierra	23 9 ^{1/16}	12	144	205885	5,20

	cm inch	MVM	CS		€
Cuillère de table Table/pasta spoon Cuchara de mesa	21,8 8 ^{9/16}	12	144	205884	3,60
Cuillère à café Coffee/tea spoon Cuchara de café	15,2 6	12	300	205886	2,95

Bleu marin

Steel blue - Azul Marino

	cm inch	MVM	CS		€
Fourchette de table Table fork Tenedor de mesa	21,6 8 ^{1/2}	12	144	226772	3,60
Couteau à steak monobloc lame scie Steak knife solid handle serrated Cuchillo de steak hoja sierra	23 9 ^{1/16}	12	144	226774	5,20

	cm inch	MVM	CS		€
Cuillère de table Table/pasta spoon Cuchara de mesa	21,8 8 ^{9/16}	12	144	226773	3,60
Cuillère à café Coffee/tea spoon Cuchara de café	15,2 6	12	300	226775	2,95

Cèpe - Taupe - Topo

	cm inch	MVM	CS		€
Fourchette de table Table fork Tenedor de mesa	21,6 8 ^{1/2}	12	144	226787	3,60
Couteau à steak monobloc lame scie Steak knife solid handle serrated Cuchillo de steak hoja sierra	23 9 ^{1/16}	12	144	226789	5,20

	cm inch	MVM	CS		€
Cuillère de table Table/pasta spoon Cuchara de mesa	21,8 8 ^{9/16}	12	144	226788	3,60
Cuillère à café Coffee/tea spoon Cuchara de café	15,2 6	12	300	226790	2,95



Quartz

NEW

Azur - Green - Verde

	cm inch	MVM	CS	€	
Fourchette de table Table fork Tenedor de mesa	21,6 8 ^{1/2}	12	144	238531	3,60
Couteau à steak monobloc lame scie Steak knife solid handle serrated Cuchillo de steak hoja sierra	23 9 ^{1/16}	12	144	238536	5,20

	cm inch	MVM	CS	€	
Cuillère de table Table/pasta spoon Cuchara de mesa	21,8 8 ^{9/16}	12	144	238533	3,60
Cuillère à café Coffee/tea spoon Cuchara de café	15,2 6	12	300	238535	2,95

NEW

Orchidée - Purple - Morado

	cm inch	MVM	CS	€	
Fourchette de table Table fork Tenedor de mesa	21,6 8 ^{1/2}	12	144	238530	3,60
Couteau à steak monobloc lame scie Steak knife solid handle serrated Cuchillo de steak hoja sierra	23 9 ^{1/16}	12	144	238537	5,20

	cm inch	MVM	CS	€	
Cuillère de table Table/pasta spoon Cuchara de mesa	21,8 8 ^{9/16}	12	144	238532	3,60
Cuillère à café Coffee/tea spoon Cuchara de café	15,2 6	12	300	238534	2,95



Serenity

	cm inch	MVM	CS	€		cm inch	MVM	CS	€		
Fourchette de table Table fork Tenedor de mesa	20,9 8 ^{3/16}	12	144	143770	8,20						
1 Couteau de table monobloc lame scie Table knife solid handle serrated Cuchillo de mesa hoja sierra	23,2 9 ^{1/8}	12	144	159484	8,35	Couteau à poisson/gourmet Gourmet/fish knife Cuchillo de pescado	20,1 7 ^{15/16}	12	144	181467	7,80
2 Couteau de table monobloc lame scie Table knife solid handle serrated Cuchillo de mesa hoja sierra	23 9 ^{1/16}	12	144	208624	8,35	Cuillère à café Coffee/tea spoon Cuchara de café	14,9 5 ^{7/8}	12	300	143772	4,95
Couteau à steak monobloc lame scie Steak knife solid handle serrated Cuchillo de steak hoja sierra	23,5 9 ^{1/4}	12	144	159451	7,40	Cuillère à moka Demi tasse spoon Cuchara de moka	11 4 ^{5/16}	12	300	148855	4,10
Cuillère de table Table/pasta spoon Cuchara de mesa	21,2 8 ^{3/8}	12	144	143767	8,20	Cuillère à soda Iced tea spoon Cuchara de soda/helado	19 7 ^{1/2}	12	144	190018	2,90
Cuillère à soupe anglaise Bouillon spoon, round Cuchara de consommé	17,1 6 ^{3/4}	12	144	148852	8,20	Fourchette à gâteaux/cocktail Pastry/cocktail fork Tenedor de pastel	14,9 5 ^{7/8}	12	300	143782	5,70
Cuillère à dessert Dessert/soup spoon, oval Cuchara de postre	18,7 7 ^{3/8}	12	144	143801	7,80	Fourchette à huîtres Oyster fork Tenedor de ostras	14,1 5 ^{9/16}	12	300	190424	2,70
Fourchette à dessert Dessert/salad fork Tenedor de postre	18,4 7 ^{1/4}	12	144	143804	7,80	Fourchette de service Serving fork Tenedor de servicio/ensalada	26,6 10 ^{1/2}	1		197522	15,50
1 Couteau à dessert monobloc lame unie Dessert knife solid handle Cuchillo de postre hoja lisa	20,4 8 ^{1/16}	12	144	159492	7,60	Cuillère de service Serving spoon Cuchara de servicio/ensalada	27 10 ^{5/8}	1		197523	15,50
2 Couteau à dessert monobloc lame scie Dessert knife solid handle serrated Cuchillo de postre hoja sierra	20,7 8 ^{1/8}	12	144	208625	7,60	Service à salade Salad serving set Set servicio de ensalada	30 11 ^{3/16}	1		197525	31,00
Tartineur Butter spreader Espatulin de mantequilla	16 6 ^{5/16}	12	144	181112	5,80	Pelle à tarte monobloc Pastry server solid handle Pala para tarta	25,1 9 ^{7/8}	1		197527	15,50
Fourchette à poisson Fish fork Tenedor de pescado	18,5 7 ^{5/16}	12	144	143790	7,80	Louche Soup ladle Cazo	29,7 11 ^{11/16}	1	12	153193	28,90
						Louche à sauce Sauce ladle Cazo para salsa	18,5 7 ^{5/16}	1		154606	16,50



	cm inch	MVM	CS		€
Fourchette de table Table fork Tenedor de mesa	20,9 8 ^{3/16}	12	144	205540	5,90
1 Couteau de table monobloc lame scie Table knife solid handle serrated Cuchillo de mesa hoja sierra	23,2 9 ^{1/8}	12	144	159484	8,35
2 Couteau de table monobloc lame scie Table knife solid handle serrated Cuchillo de mesa hoja sierra	23 9 ^{1/16}	12	144	208624	8,35
Couteau à steak monobloc lame scie Steak knife solid handle serrated Cuchillo de steak hoja sierra	23,5 9 ^{1/4}	12	144	159451	7,40
Cuillère de table Table/pasta spoon Cuchara de mesa	20,9 8 ^{1/4}	12	144	205541	5,90
Cuillère à soupe anglaise Bouillon spoon, round Cuchara de consommé	17,8 7	12	144	205542	5,90
Cuillère à dessert Dessert/soup spoon, oval Cuchara de postre	18,4 7 ^{1/4}	12	144	205547	5,70
Fourchette à dessert Dessert/salad fork Tenedor de postre	18,4 7 ^{1/4}	12	144	205546	5,70
1 Couteau à dessert monobloc lame unie Dessert knife solid handle Cuchillo de postre hoja lisa	20,4 8 ^{1/16}	12	144	159492	7,60
2 Couteau à dessert monobloc lame scie Dessert knife solid handle serrated Cuchillo de postre hoja sierra	20,7 8 ^{1/8}	12	144	208625	7,60
Couteau à beurre monobloc lame unie Butter knife solid handle Cuchillo de mantequilla hoja lisa	19,4 7 ^{5/8}	12	144	154612	3,50
Fourchette à poisson Fish fork Tenedor de pescado	18,4 7 ^{1/4}	12	144	205544	5,70

	cm inch	MVM	CS		€
Couteau à poisson/gourmet Gourmet/fish knife Cuchillo de pescado	20,7 8 ^{1/8}	12	144	205545	5,70
Cuillère à café Coffee/tea spoon Cuchara de café	14 5 ^{1/2}	12	300	205543	3,55
Cuillère à moka Demi tasse spoon Cuchara de moka	11,1 4 ^{3/8}	12	300	159512	2,95
Cuillère à soda Iced tea spoon Cuchara de soda/helado	19 7 ^{1/2}	12	144	190018	2,90
Fourchette à gâteaux/cocktail Pastry/cocktail fork Tenedor de pastel	14,1 5 ^{3/16}	12	300	205548	4,20
Fourchette à huîtres Oyster fork Tenedor de ostras	14,5 5 ^{11/16}	12	300	190424	2,70
Fourchette de service Serving fork Tenedor de servicio/ensalada	26 10 ^{1/4}	1		159501	17,90
Cuillère de service Serving spoon Cuchara de servicio/ensalada	26 10 ^{1/4}	1		159500	17,90
Service à salade Salad serving set Set servicio de ensalada	30 11 ^{3/16}	1		159504	35,80
Pelle à tarte monobloc Pastry server solid handle Pala para tarta	26,2 10 ^{1/4}	1		159490	17,90
Louche Soup ladle Cazo	29,7 11 ^{11/16}	1	12	153193	28,90
Louche à sauce Sauce ladle Cazo para salsa	18,5 7 ^{5/16}	1		154606	16,50



Squadro

	cm inch	MVM	CS		€		cm inch	MVM	CS		€
Fourchette de table Table fork Tenedor de mesa	20,7 8 ^{1/8}	12	144	205533	6,65	Fourchette à poisson Fish fork Tenedor de pescado	18,2 7 ^{3/16}	12	144	205538	6,30
Couteau de table manche orfèvre lame scie Table knife hollow handle serrated Cuchillo de mesa enmangado hoja sierra	23,3 9 ^{3/16}	12	144	199160	13,90	Couteau à poisson Fish knife Cuchillo de pescado	21,2 8 ^{3/8}	12	144	205537	6,30
Couteau de table manche orfèvre lame scie ronde Table knife hollow handle serrated rounded blade Cuchillo de mesa enmangado redonda hoja sierra	23,3 9 ^{3/16}	12	144	215601	13,90	Cuillère à café Coffee/tea spoon Cuchara de café	14,1 5 ^{9/16}	12	300	199159	3,95
Cuillère de table Table/pasta spoon Cuchara de mesa	20,7 8 ^{1/8}	12	144	205534	6,65	Cuillère à moka Demi tasse spoon Cuchara de moka	11,2 4 ^{7/16}	12	300	199161	3,35
Cuillère à soupe anglaise Bouillon spoon, round Cuchara de consommé	17,7 6 ^{15/16}	12	144	205535	6,65	Cuillère à soda Iced tea spoon Cuchara de soda/helado	18,8 7 ^{3/8}	12	144	199169	4,65
Cuillère à dessert Dessert/soup spoon, oval Cuchara de postre	18,2 7 ^{3/16}	12	144	205539	6,30	Fourchette à gâteaux Pastry fork Tenedor de pastel	14,2 5 ^{9/16}	12	300	199167	4,65
Fourchette à dessert Dessert/salad fork Tenedor de postre	18,2 7 ^{3/16}	12	144	205538	6,30	Fourchette de service Serving fork Tenedor de servicio/ensalada	25 9 ^{13/16}	1		199172	16,30
Couteau à dessert manche orfèvre lame unie Dessert knife hollow handle serrated Cuchillo de postre enmangado hoja lisa	20,6 8 ^{1/8}	12	144	199164	13,25	Cuillère de service Serving spoon Cuchara de servicio/ensalada	25 9 ^{13/16}	1		199171	16,30
Couteau à dessert manche orfèvre lame unie ronde Dessert knife hollow handle rounded blade Cuchillo de postre enmangado redonda hoja lisa	20,6 8 ^{1/8}	12	144	215602	13,25	Pelle à tarte monobloc Pastry server solid handle Pala para tarta	23,9 9 ^{7/16}	1		199173	16,30
Couteau à beurre manche orfèvre lame unie Butter knife hollow handle Cuchillo de mantequilla enmangado hoja lisa	18,5 7 ^{5/16}	12	144	199170	13,25	Louche Soup ladle Cazo	30,2 11 ^{7/8}	1	12	199174	30,90

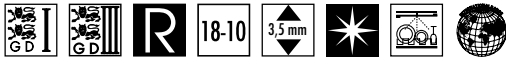

	cm inch	MVM	CS		€
Fourchette de table Table fork Tenedor de mesa	20,8 8 ^{3/16}	12	144	105831	6,35
Couteau de table monobloc lourd lame scie Table knife solid handle serrated Cuchillo de mesa pesado hoja sierra	24,6 9 ^{11/16}	12	96	182460	7,95
Couteau de table manche orfèvre lame unie Table knife hollow handle Cuchillo de mesa emangado hoja lisa	24,6 9 ^{11/16}	12	144	105886	13,35
Couteau de table manche orfèvre lame scie Table knife hollow handle serrated Cuchillo de mesa emangado hoja sierra	24,6 9 ^{11/16}	12	144	105860	13,35
Couteau à steak manche orfèvre lame scie Steak knife hollow handle serrated Cuchillo de steak emangado hoja sierra	23,9 9 ^{7/16}	12	144	105801	13,35
Cuillère de table Table/pasta spoon Cuchara de mesa	20,8 8 ^{3/16}	12	144	105798	6,35
Cuillère à soupe anglaise* Bouillon spoon, round Cuchara de consommé	17,2 6 ^{3/4}	12	144	112692	2,75
Cuillère à dessert Dessert/soup spoon, oval Cuchara de postre	18 7 ^{1/16}	12	144	105861	6,05
Fourchette à dessert Dessert/salad fork Tenedor de postre	17,8 7	12	144	105885	6,05
Couteau à dessert monobloc lourd lame unie Dessert knife solid handle Cuchillo de postre pesado hoja lisa	21,1 8 ^{5/16}	12	144	182463	7,30
Couteau à dessert manche orfèvre lame unie Dessert knife hollow handle Cuchillo de postre emangado hoja lisa	20,5 8 ^{1/16}	12	144	105832	12,70
Couteau à beurre monobloc lourd lame unie Butter knife solid handle Cuchillo de mantequilla pesado hoja lisa	19 7 ^{1/2}	12	144	190420	7,30
Couteau à beurre manche orfèvre lame unie Butter knife hollow handle Cuchillo de mantequilla hoja lisa	18,7 7 ^{3/8}	12	144	003332	12,70
Fourchette à poisson* Fish fork Tenedor de pescado	17,8 7	12	144	108918	2,65
Couteau à poisson* Fish knife Cuchillo de pescado	19,7 7 ^{3/4}	12	144	108920	2,65
Cuillère à sauce/gourmet Gourmet/sauce spoon Cuchara para salsa	17,9 7 ^{1/16}	12	300	105910	6,05

	cm inch	MVM	CS		€
Cuillère à café Coffee/tea spoon Cuchara de café	14 5 ^{1/2}	12	300	105833	3,85
Cuillère à moka Demi tasse spoon Cuchara de moka	11 4 ^{5/16}	12	300	105906	3,20
Cuillère à soda Iced tea spoon Cuchara de soda/helado	18,2 7 ^{3/16}	12	300	105800	3,70
Fourchette à gâteaux Pastry fork Tenedor de pastel	13,8 5 ^{7/16}	12	300	105795	4,45
Fourchette à huîtres* Oyster fork Tenedor de ostras	12,9 5 ^{1/16}	12	300	123440	1,80
Fourchette à escargots* Snail fork Tenedor de caracoles	13,5 5 ^{5/16}	12	300	132782	1,65
Cuillère à toast Appetizer spoon Cuchara de aperitivo	11,8 4 ^{5/8}	1	50	130994	2,60
Couteau à fromage manche orfèvre lame unie Cheese knife hollow handle Cuchillo queso emangado	19,3 7 ^{5/8}	1	25	003390	16,80
Fourchette de service Serving fork Tenedor de servicio/ensalada	24,8 9 ^{3/4}	1		002185	15,50
Cuillère de service Serving spoon Cuchara de servicio/ensalada	25 9 ^{13/16}	1		002186	15,50
Service à salade Salad serving set Set servicio de ensalada	25,8 10 ^{3/16}	1		040646	30,80
Pelle à tarte monobloc Pastry server solid handle Pala para tarta	24,9 9 ^{13/16}	1		083340	15,50
Louche Soup ladle Cazo	29,8 11 ^{3/4}	1	12	097717	29,50
Louche à sauce Sauce ladle Cazo para salsa	15,7 6 ^{3/16}	1		002179	25,80
Pince à sucre Sugar tong Pinza para azúcar	11,5 4 ^{1/2}	12		002191	4,15

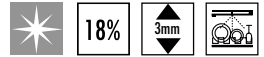

Vieux Paris Satiné

	cm inch	MVM	CS		€		cm inch	MVM	CS		€
Fourchette de table Table fork Tenedor de mesa	21 8 ^{1/4}	12	144	105804	2,25	Couteau à dessert manche orfèvre lame unie Dessert knife hollow handle Cuchillo de postre enmangado hoja lisa	20,5 8 ^{1/16}	12	144	105802	11,15
Couteau de table monobloc lame scie Table knife solid handle serrated Cuchillo de mesa hoja sierra	25 9 ^{13/16}	12	144	105892	2,95	Fourchette à poisson Fish fork Tenedor de pescado	18 7 ^{1/16}	12	144	105837	2,15
Couteau de table manche orfèvre lame unie Table knife hollow handle Cuchillo de mesa enmangado hoja lisa	24,7 9 ^{3/4}	12	144	105864	11,65	Couteau à poisson Fish knife Cuchillo de pescado	20 7 ^{7/8}	12	144	105912	2,15
Couteau de table manche orfèvre lame scie Table knife hollow handle serrated Cuchillo de mesa enmangado hoja sierra	24,7 9 ^{3/4}	12	144	105913	11,65	Cuillère à café Coffee/tea spoon Cuchara de café	14,1 5 ^{3/16}	12	300	105838	1,40
Couteau à steak monobloc lame scie Steak knife solid handle serrated Cuchillo de steak hoja sierra	23,2 9 ^{1/8}	12	144	160424	2,95	Cuillère à moka Demi tasse spoon Cuchara de moka	11 4 ^{5/16}	12	300	105891	1,20
Cuillère de table Table/pasta spoon Cuchara de mesa	21 8 ^{1/4}	12	144	105911	2,25	Fourchette à gâteaux Pastry fork Tenedor de pastel	13,9 5 ^{1/2}	12	300	105805	1,65
Cuillère à dessert Dessert/soup spoon, oval Cuchara de postre	18 7 ^{1/16}	12	144	105863	2,15	Fourchette à huîtres Oyster fork Tenedor de ostras	13,2 5 ^{3/16}	12	300	105803	1,55
Fourchette à dessert Dessert/salad fork Tenedor de postre	18 7 ^{1/16}	12	144	105890	2,15	Fourchette de service Serving fork Tenedor de servicio/ensalada	24,6 9 ^{11/16}	1		000490	6,90
Couteau à dessert monobloc lame scie Dessert knife solid handle serrated Cuchillo de postre hoja sierra	20,7 8 ^{1/8}	12	144	210626	2,75	Cuillère de service Serving spoon Cuchara de servicio/ensalada	24,9 9 ^{13/16}	1		000491	6,90



XY Miroir

	cm inch	MVM	CS	€	
Fourchette de table Table fork Tenedor de mesa	21,3 8 ^{3/8}	12	144	205559	7,25
Couteau de table monobloc lame scie Table knife solid handle serrated Cuchillo de mesa hoja sierra	23,3 9 ^{3/16}	12	144	193776	9,40
Cuillère de table Table/pasta spoon Cuchara de mesa	20,5 8 ^{1/16}	12	144	205560	7,25
Cuillère à soupe anglaise Bouillon spoon, round Cuchara de consomé	18,5 7 ^{5/16}	12	144	205561	7,25
Cuillère gourmande Dessert/soup spoon, oval Cuchara de postre	18,6 7 ^{5/16}	12	144	205567	6,90
Fourchette gourmande Dessert/salad fork Tenedor de postre	18,6 7 ^{5/16}	12	144	205566	6,90
Couteau à dessert monobloc lame unie Dessert knife solid handle Cuchillo de postre hoja lisa	20,6 8 ^{1/8}	12	144	181111	8,65
Tartineur Butter spreader Espatulin de mantequilla	16 6 ^{5/16}	12	144	181112	5,80
Fourchette à poisson Fish fork Tenedor de pescado	20 7 ^{7/8}	12	144	205563	6,90
Spatule gourmet Gourmet spatula Espátula gourmet	20,2 7 ^{15/16}	12	144	205564	6,90
Fourchette gourmet Gourmet fork Tenedor gourmet	20 7 ^{7/8}	12	144	205565	6,90
Cuillère à café Coffee/tea spoon Cuchara de café	14,3 5 ^{5/8}	12	300	205562	4,40

	cm inch	MVM	CS	€	
Cuillère à moka Demi tasse spoon Cuchara de moka	11 4 ^{5/16}	12	300	181109	3,65
Cuillère à soda Iced tea spoon Cuchara de soda/helado	19 7 ^{1/2}	12	144	190018	2,90
Fourchette mise en bouche Appetizer fork Tenedor aperitivo	15,5 6 ^{1/8}	12	300	181119	4,40
Spatule mise en bouche Appetizer spatula Espátula aperitivo	15,5 6 ^{1/8}	12	300	181120	4,40
Cuillère mise en bouche Appetizer spoon Cuchara aperitivo	11,6 4 ^{9/16}	12	300	181121	2,95
Fourchette à huîtres Oyster fork Tenedor de ostras	14,1 5 ^{11/16}	12	300	190424	2,70
Fourchette de service Serving fork Tenedor de servicio/ensalada	26 10 ^{1/4}	1		181114	21,90
Cuillère de service Serving spoon Cuchara de servicio/ensalada	26 10 ^{1/4}	1		181113	21,90
Spatule de service Serving spatula Espátula de servicio	25 9 ^{13/16}	1		181122	21,90
Service à salade Salad serving set Set servicio de ensalada	30 11 ^{13/16}	1		189999	43,80
Louche Soup ladle Cazo	29,7 11 ^{11/16}	1		153193	28,90
Louche à sauce Sauce ladle Cazo para salsa	18,5 7 ^{5/16}	1		154606	16,50



XY Black Miroir

	cm inch	MVM	CS		€		cm inch	MVM	CS		€
Fourchette de table Table fork Tenedor de mesa	21,3 8 ^{3/8}	12	144	205568	18,30	Cuillère à café Coffee/tea spoon Cuchara de café	14,3 5 ^{5/8}	12	300	205570	12,25
Couteau de table monobloc lame scie Table knife solid handle serrated Cuchillo de mesa hoja sierra	23,3 9 ^{3/16}	12	144	195028	26,20	Cuillère à moka Demi tasse spoon Cuchara de moka	11 4 ^{5/16}	12	300	195034	10,95
Cuillère de table Table/pasta spoon Cuchara de mesa	20,5 8 ^{1/16}	12	144	205569	18,30	Cuillère à soda Iced tea spoon Cuchara de soda/helado	19 7 ^{1/2}	12	144	196674	12,75
Cuillère à soupe anglaise Bouillon spoon, round Cuchara de consomé	18,5 7 ^{5/16}	12	144	200483	18,30	Fourchette mise en bouche* Cocktail fork Tenedor aperitivo	15,5 6 ^{1/8}	12	300	195039	13,55
Cuillère gourmande Dessert/soup spoon, oval Cuchara de postre	18,6 7 ^{5/16}	12	144	205575	17,75	Spatule mise en bouche* Cocktail spatula Espátula aperitivo	15,5 6 ^{1/8}	12	300	195042	13,55
Fourchette gourmande Dessert/salad fork Tenedor de postre	18,6 7 ^{5/16}	12	144	205574	17,75	Cuillère mise en bouche* Cocktail spoon Cuchara aperitivo	11,6 4 ^{9/16}	12	300	195041	12,15
Couteau à dessert monobloc lame unie Dessert knife solid handle Cuchillo de postre hoja lisa	20,6 8 ^{1/8}	12	144	195031	25,05	Fourchette à huîtres* Oyster fork Tenedor de ostras	14,1 5 ^{9/16}	12	300	196014	12,05
Tartineur* Butter spreader Espátula de mantequilla	16 6 ^{5/16}	12	144	195036	16,05	Fourchette de service Serving fork Tenedor de servicio/ensalada	26 10 ^{1/4}	1		199773	46,90
Fourchette à poisson Fish fork Tenedor de pescado	20 7 ^{7/8}	12	144	205571	17,75	Cuillère de service Serving spoon Cuchara de servicio/ensalada	26 10 ^{1/4}	1		199774	46,90
Spatule gourmet Gourmet spatula Espátula gourmet	20,2 7 ^{15/16}	12	144	205572	17,75	Spatule de service Serving spatula Espátula de servicio	25 9 ^{13/16}	1		199769	48,80
Fourchette gourmet* Gourmet fork Tenedor gourmet	20 7 ^{7/8}	12	144	205573	17,75	Service à salade Salad serving set Set servicio de ensalada	30 11 ^{13/16}	1		199771	96,80

* Disponible sur commande / Available upon order receipt / Disponible bajo pedido



Couteaux à steak Steak knives - Cuchillos steak

COUVERTS
FLATWARE - CUBIERTOS



Laguiole

	cm inch	MVM		€
Couteau à steak Laguiole corne noire mitre inox Laguiole steak knife black horn steel bolster Laguiole cuchillo steak cuerno mitra acero	23 9 ^{1/16}	6	232249	43,25
Couteau à steak Laguiole corne claire mitre laiton Laguiole steak knife light horn brass bolster Laguiole cuchillo steak cuerno claro mitra laton	23 9 ^{1/16}	6	232251	43,25
Couteau à steak Laguiole ivoirine mitre inox Laguiole steak knife ivory color steel bolster Laguiole cuchillo steak color marfil mitra acero	23 9 ^{1/16}	6	232253	40,20
Couteau à steak Laguiole olivier mitre laiton Laguiole steak knife olive wood brass bolster Laguiole cuchillo steak olivo mitra laton	23 9 ^{1/16}	6	232255	40,20



Mirage Les Essences

	cm inch	MVM		€
Couteau à steak manche Olivier Steak knife Olive wood handle Cuchillo steak mango de madera de Olivo	23 9 ^{1/16}	6	233848	32,95
Couteau à steak manche Picana Steak knife Picana handle Cuchillo steak mango de Picana	23 9 ^{1/16}	6	233853	32,95
Couteau à steak manche Ébène Steak knife Ebony handle Cuchillo steak mango de Ébano	23 9 ^{1/16}	6	233851	32,95

Capucin



	cm inch	MVM		€
Couteau à steak Capucin noir Black Capucin steak knife Cuchillo steak Capucin negro	22,6 8 ^{7/8}	6	232243	23,70
Couteau à steak Capucin ivoirine Ivory color Capucin steak knife Cuchillo steak Capucin color marfil	22,6 8 ^{7/8}	6	232245	23,70
Couteau à steak Capucin rouge Red Capucin steak knife Cuchillo steak Capucin rojo	22,6 8 ^{7/8}	6	232247	23,70



Mirage

	cm inch	MVM		€
Couteau de table/steak lame unie anthracite Black table/steak knife Cuchillo de mesa/steak negro	23 9 ^{1/16}	6	226261	23,70
Couteau de table/steak lame unie blanc White table/steak knife Cuchillo de mesa/steak blanco	23 9 ^{1/16}	6	226263	23,70



Couteaux à steak - autres modèles

Steak knives - other collections - Cuchillos steak - otros modelos

	cm - inch	MVM	CS		€
Aloa - Aquatic	23,6 - 9 ^{5/16}	12	144	207189	5,30
Astrée miroir - Grillade	22,1 - 8 ^{11/16}	12	144	122418	4,50
Astrée ciselé	22,8 - 9	12	144	199761	7,00
Blois	23,9 - 9 ^{7/16}	12	144	122759	11,70
Confidence	23,6 - 9 ^{5/16}	12	144	160433	3,60
Florenzia	23,9 - 9 ^{7/16}	12	144	127654	13,90
Gourmet - Serenity - Solstice	23,5 - 9 ^{1/4}	12	144	159451	7,40
Guest	23,2 - 9 ^{1/8}	12	144	197521	6,65
Guest star	23,2 - 9 ^{1/8}	12	144	203017	8,80
Lutèce	23,8 - 9 ^{3/8}	12	144	122746	13,05
Marquise	23,9 - 9 ^{7/16}	12	144	186278	13,90

	cm - inch	MVM	CS		€
Mikado	23,2 - 9 ^{1/8}	12	144	160427	3,60
Mikado Vintage	23,2 - 9 ^{1/8}	12	144	230293	4,05
Milady	23,9 - 9 ^{7/16}	12	144	128841	13,90
Quartz azur <u>NEW</u>	23 - 9 ^{1/16}	12	144	238536	5,20
Quartz bleu marin	23 - 9 ^{1/16}	12	144	226774	5,20
Quartz carbone	23 - 9 ^{1/16}	12	144	205885	5,20
Quartz cèpe	23 - 9 ^{1/16}	12	144	226789	5,20
Quartz orchidée <u>NEW</u>	23 - 9 ^{1/16}	12	144	238537	5,20
Verlaine	23,9 - 9 ^{7/16}	12	144	105801	13,35
Vieux Paris satiné	23,2 - 9 ^{1/8}	12	144	160424	2,95

DEGRENNE vous offre un service d'argenterie à la demande pour tous les couverts en acier 18-10. Nous vous proposons deux types d'argenterie se référant aux normes en vigueur. L'argenterie DEGRENNE est réalisée dans la tradition des grands orfèvres ; la main de l'homme y tient une grande place et chaque détail fait la différence.

DEGRENNE offers a silver plating service on request, for all 18/10 stainless steel cutlery. We offer two types of silver plating; both comply with current standards. DEGRENNE'S silver plating service respects the traditions of the finest silversmiths: the hands of the master craftsmen play an important role, and every detail makes a difference.

Argenterie type classe I - 33 microns avec poinçon de maître
Class 1 silver plating - 33 microns with hallmark

Couverts table et autres : 24 pièces minimum
Table and other cutlery : minimum 24 pieces

Couverts de service : pas de quantité minimum
Serving cutlery : no minimum quantity



Argenterie Qualité Hôtelière
Silver plated hotel quality

Couverts table (fourchette de table, cuillère de table, couteau de table, cuillère à café) : minimum 144 pièces

Table cutlery (table fork, table knife, table/pasta spoon, coffee/tea spoon) : minimum 144 pieces

Autres couverts : minimum 24 pièces
Other cutlery : minimum 24 pieces

Couverts de service : pas de quantité minimum
Serving cutlery : no minimum quantity



Pour des raisons techniques, une tolérance de plus ou moins 5% est applicable sur les quantités.

For technical reasons, a tolerance of more or less 5% on quantities is applicable.

Délai : 4 à 8 semaines. Délai à valider lors de la confirmation de commande auprès de notre service client.

Lead time : 4 to 8 weeks. Lead time to be confirmed after the order has been recorded, please contact our customer service.

fourchette de table
table fork - tenedor de mesa **13,95**

couteau de table/steak/fromage
table knife/steak/cheese - cuchillo de mesa/steak/queso **13,95**

cuillère de table
table/pasta spoon - cuchara de mesa **13,95**

cuillère à dessert/gourmande/soupe anglaise/gourmet
dessert/bouillon gourmet spoon - cuchara de postre/consomé/salsa **11,15**

cuillère à café
coffee/tea spoon - cuchara de café **9,15**

fourchette à dessert/gourmande/poisson/gourmet
dessert/fish/gourmet fork - tenedor de postre/pescado/gourmet **11,15**

couteau à poisson/gourmet/spatule
fish/gourmet/spatula knife - cuchillo de pescado/espátula **11,15**

couteau à dessert/beurre
dessert/butter knife - cuchillo de postre/mantequilla **11,15**

cuillère à moka
demi tasse spoon - cuchara de moka **5,75**

cuillère à soda/agrumes/spatule mise en bouche
iced tea/citrus fruits spoon/appetizer spatula
cuchara de soda/helado/pomelo/espátula aperitivo **9,15**

fourchette à gâteaux/cocktail/mise en bouche
pastry/cocktail/appetizer fork - tenedor de pastel/aperitivo **9,15**

fourchette à huîtres/escargots
oyster/snail fork - tenedor de ostras/caracoles **9,15**

fourchette de service/salade/à découper
serving/salad/carving fork
tenedor de servicio/ensalada/trinchante **26,30**

cuillère de service/salade/couteau à découper
serving/salad spoon/carving knife
cuchara de servicio/ensalada/cuchillo trinchante **26,30**

louche
soup ladle - cazo **30,95**

cuillère à sauce
sauce ladle - cuchara para salsa **26,30**

tartineur/cuillère mise en bouche/toast
butter spreader/appetizer spoon
espatulin de mantequilla/cuchara de aperitivo **11,15**

pelle à tarte monobloc/spatule de service
pastry server solid handle/serving spatula
pala para tarta/espátula de servicio **26,30**

pelle à tarte manche orfèvre
pastry server hollow handle
pala para tarta enmangado **30,95**

pince à sucre
sugar tong - pinza para azúcar **14,65**

service à salade
salad serving set - set servicio/ensalada **42,30**

fourchette de table
table fork - tenedor de mesa **9,05**

couteau de table/steak/fromage
table knife/steak/cheese - cuchillo de mesa/steak/queso **9,05**

cuillère de table
table/pasta spoon - cuchara de mesa **9,05**

cuillère à dessert/gourmande/soupe anglaise/gourmet
dessert/bouillon gourmet spoon - cuchara de postre/consomé/salsa **7,95**

cuillère à café
coffee/tea spoon - cuchara de café **5,95**

fourchette à dessert/gourmande/poisson/gourmet
dessert/fish/gourmet fork - tenedor de postre/pescado/gourmet **7,95**

couteau à poisson/gourmet/spatule
fish/gourmet/spatula knife - cuchillo de pescado/espátula **7,95**

couteau à dessert/beurre
dessert/butter knife - cuchillo de postre/mantequilla **7,95**

cuillère à moka
demi tasse spoon - cuchara de moka **4,85**

cuillère à soda/agrumes/spatule mise en bouche
iced tea/citrus fruits spoon/appetizer spatula
cuchara de soda/helado/pomelo/ espátula aperitivo **5,95**

fourchette à gâteaux/cocktail/mise en bouche
pastry/cocktail/appetizer fork - tenedor de pastel/aperitivo **5,95**

fourchette à huîtres/escargots
oyster/snail fork - tenedor de ostras/caracoles **5,95**

fourchette de service/salade/à découper
serving/salad/carving fork
tenedor de servicio/ensalada/trinchante **17,45**

cuillère de service/salade/couteau à découper
serving/salad spoon/carving knife
cuchara de servicio/ensalada/cuchillo trinchante **17,45**

louche
soup ladle - cazo **22,35**

cuillère à sauce
sauce ladle - cuchara para salsa **17,45**

tartineur/cuillère mise en bouche/toast
butter spreader/appetizer spoon
espatulin de mantequilla/cuchara de aperitivo **7,95**

pelle à tarte monobloc/spatule de service
pastry server solid handle/serving spatula
pala para tarta/espátula de servicio **17,45**

pelle à tarte manche orfèvre
pastry server hollow handle
pala para tarta enmangado **22,40**

pince à sucre
sugar tong - pinza para azúcar **9,50**

service à salade
salad serving set - set servicio/ensalada **36,50**



DEGRENNE
PARIS

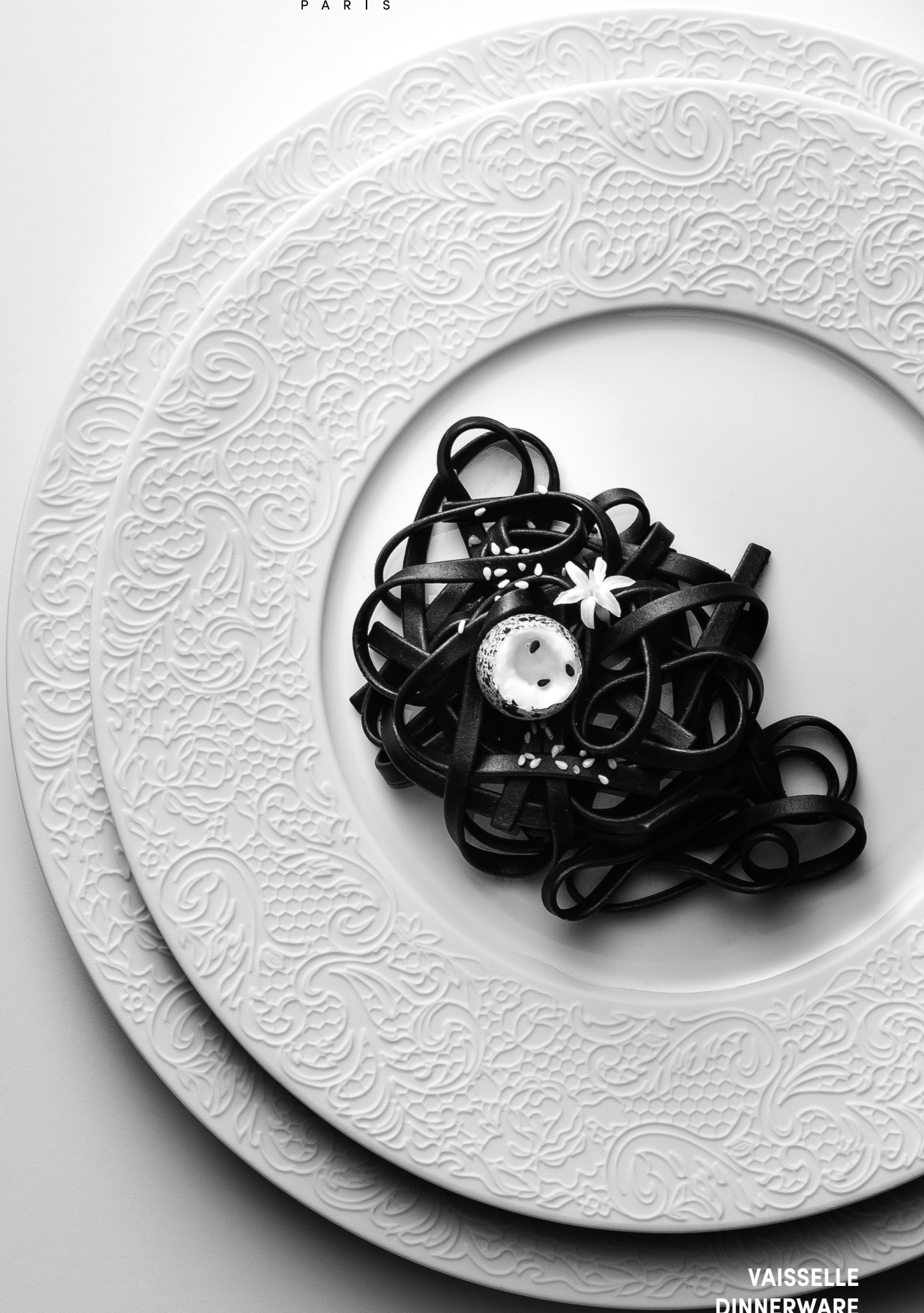

VAISSELLE
DINNERWARE
VAJILLA

API



	cm - inch	MVM	CS	€		cm - inch	MVM	CS	€	
Assiette compartimentée rectangulaire Rectangular plate w/small compartments and saucer Plato rectangular 6 compartimentos	27 x 18 10 ^{5/8} x 7 ^{1/16}	6	12	207131	13,30	Soucoupe rectangulaire Rectangular plate/saucer Plato rectangular	27 x 9 10 ^{5/8} x 3 ^{9/16}	6	207133	10,00

Bahia

Onyx
Onyx - Onyx **NEW**



	cl oz	cm inch	MVM	CS	€		cl oz	cm inch	MVM	CS	€	
Assiette plate ronde Round dessert/salad/app. plate Plato redondo		23 9 ^{1/16}	6	24	236547	10,60	Bol biseauté cocotte Slanted rim bowl Bol biseado cocotte	7 2	7,3 2 ^{7/8}	6	236553	6,90
Assiette plate ronde Round dinner plate Plato redondo		26 10 ^{1/4}	6	24	236548	12,80	Bol biseauté cocotte Slanted rim bowl Bol biseado cocotte	30 10 ^{1/8}	12 4 ^{3/4}	6	236554	10,65
Assiette plate ronde Round presentation plate Plato redondo		29 11 ^{7/16}	3	12	236549	21,00	Bol cocotte Round casserole Bol cocotte	50 16 ^{15/16}	14 5 ^{1/2}	6	236555	12,05
Assiette creuse ronde Round soup/pasta bowl w/rim Plato hondo		20 7 ^{7/8}	6	12	236550	11,40	Assiette/couvercle Round plate/casserole lid Bol/plato pan rondo		12,5 4 ^{15/16}	6	236556	8,70
Assiette gourmet ronde petit bassin Round shallow bowl w/wide-rim Plato gourmet fondo pequeño		23 9 ^{1/16}	6	24	236551	17,60	Tasse à espresso Coffee cup Espresso taza	11 3 ^{3/4}		6	236557	7,40
Assiette gourmet ronde grand bassin Round shallow bowl w/wide-rim Plato gourmet fondo grande		26 10 ^{1/4}	3	12	236552	18,70	Tasse à thé Tea cup Tè taza	20 6 ^{3/4}		6	237206	17,50
Assiette à pain ronde Round bread & butter plate Plato de pan		14 5 ^{1/2}	6	18	236546	7,00	Planche Board Plancha		25 x 13,5 9 ^{13/16} x 5 ^{5/16}	1	237206	17,50

Basalte

Brown basalt - Basalto

	cl oz	cm inch	MVM	CS	€		cl oz	cm inch	MVM	CS	€	
Assiette plate ronde Round dessert/salad/app. plate Plato redondo		23 9 ^{1/16}	6	24	230936	9,45	Bol biseauté cocotte Slanted rim bowl Bol biseado cocotte	7 2	7,3 2 ^{7/8}	6	230942	6,00
Assiette plate ronde Round dinner plate Plato redondo		26 10 ^{1/4}	6	24	230937	11,70	Bol biseauté cocotte Slanted rim bowl Bol biseado cocotte	30 10 ^{1/8}	12 4 ^{3/4}	6	230943	9,60
Assiette plate ronde Round presentation plate Plato redondo		29 11 ^{7/16}	3	12	230938	19,50	Bol cocotte Round casserole Bol cocotte	50 16 ^{15/16}	14 5 ^{1/2}	6	230944	11,00
Assiette creuse ronde Round soup/pasta bowl w/rim Plato hondo		20 7 ^{7/8}	6	12	230939	10,35	Assiette/couvercle Round plate/casserole lid Bol/plato pan rondo		12,5 4 ^{15/16}	6	230945	7,70
Assiette gourmet ronde petit bassin Round shallow bowl w/wide-rim Plato gourmet fondo pequeño		23 9 ^{1/16}	6	24	230940	16,50	Tasse à espresso Coffee cup Espresso taza	11 3 ^{3/4}		6	230946	6,50
Assiette gourmet ronde grand bassin Round shallow bowl w/wide-rim Plato gourmet fondo grande		26 10 ^{1/4}	3	12	230941	17,60	Mug à thé Tea mug Tè mug	38 12 ^{7/8}		6	230947	10,30
Assiette à pain ronde Round bread & butter plate Plato de pan		14 5 ^{1/2}	6	18	230935	6,50	Tasse à thé Tea cup Tè taza	20 6 ^{3/4}		6	230948	8,95



Argile verte
Green clay
Arcilla verde



	cl oz	cm inch	MVM	CS	€
Assiette plate ronde Round dessert/salad/app. plate Plato redondo		23 9 ^{1/16}	6	24	230950 9,45
Assiette plate ronde Round dinner plate Plato redondo		26 10 ^{1/4}	6	24	230951 11,70
Assiette plate ronde Round presentation plate Plato redondo		29 11 ^{7/16}	3	12	230952 19,50
Assiette creuse ronde Round soup/pasta bowl w/rim Plato hondo		20 7 ^{7/8}	6	12	230953 10,35
Assiette gourmet ronde petit bassin Round shallow bowl w/wide-rim Plato gourmet fondo pequeno		23 9 ^{1/16}	6	24	230954 16,50
Assiette gourmet ronde grand bassin Round shallow bowl w/wide-rim Plato gourmet fondo grande		26 10 ^{1/4}	3	12	230955 17,60
Assiette à pain ronde Round bread & butter plate Plato de pan		14 5 ^{1/2}	6	18	230949 6,50
Bol biseauté cocotte Slanted rim bowl Bol biseado cocotte	7 2	7,3 2 ^{7/8}	6		230956 6,00

	cl oz	cm inch	MVM	CS	€
Bol biseauté cocotte Slanted rim bowl Bol biseado cocotte	30 10 ^{1/8}	12 4 ^{3/4}	6		230957 9,60
Bol cocotte Round casserole Bol cocotte	50 16 ^{5/16}	14 5 ^{1/2}	6		230958 11,00
Assiette/couvercle Round plate/casserole lid Bol/plato pan rondo		12,5 4 ^{15/16}	6		230959 7,70
Tasse à espresso Coffee cup Espresso taza	11 3 ^{3/4}		6		230960 6,50
Mug à thé Tea mug Tè mug	38 12 ^{7/8}		6		230961 10,30
Tasse à thé Tea cup Tè taza	20 6 ^{3/4}		6		230962 8,95
Planche Board NEW Plancha		25 x 13,5 9 ^{13/16} x 5 ^{5/16}	1		234949 17,50

Bleu de roche
Blue stone
Azul de roca



	cl oz	cm inch	MVM	CS	€
Assiette plate ronde Round dessert/salad/app. plate Plato redondo		23 9 ^{1/16}	6	24	230964 9,45
Assiette plate ronde Round dinner plate Plato redondo		26 10 ^{1/4}	6	24	230965 11,70
Assiette plate ronde Round presentation plate Plato redondo		29 11 ^{7/16}	3	12	230966 19,50
Assiette creuse ronde Round soup/pasta bowl w/rim Plato hondo		20 7 ^{7/8}	6	12	230967 10,35
Assiette gourmet ronde petit bassin Round shallow bowl w/wide-rim Plato gourmet fondo pequeno		23 9 ^{1/16}	6	24	230968 16,50
Assiette gourmet ronde grand bassin Round shallow bowl w/wide-rim Plato gourmet fondo grande		26 10 ^{1/4}	3	12	230969 17,60
Assiette à pain ronde Round bread & butter plate Plato de pan		14 5 ^{1/2}	6	18	230963 6,50
Saladier Bowl NEW Bol	400 135 ^{1/4}	28 11	1		235222 56,70

	cl oz	cm inch	MVM	CS	€
Planche Board NEW Plancha		25 x 13,5 9 ^{13/16} x 5 ^{5/16}	1		234950 17,50
Bol biseauté cocotte Slanted rim bowl Bol biseado cocotte	7 2	7,3 2 ^{7/8}	6		230970 6,00
Bol biseauté cocotte Slanted rim bowl Bol biseado cocotte	30 10 ^{1/8}	12 4 ^{3/4}	6		230971 9,60
Bol cocotte Round casserole Bol cocotte	50 16 ^{5/16}	14 5 ^{1/2}	6		230972 11,00
Assiette/couvercle Round plate/casserole lid Bol/plato pan rondo		12,5 4 ^{15/16}	6		230973 7,70
Tasse à espresso Coffee cup Espresso taza	11 3 ^{3/4}		6		230974 6,50
Mug à thé Tea mug Tè mug	38 12 ^{7/8}		6		230975 10,30
Tasse à thé Tea cup Tè taza	20 6 ^{3/4}		6		230976 8,95



Bahia

Dune - Beige dune
Beis duna



	cl oz	cm inch	MVM	CS	€
Assiette plate ronde Round dessert/salad/app. plate Plato redondo		23 9 ^{1/16}	6	24	230919 9,45
Assiette plate ronde Round dinner plate Plato redondo		26 10 ^{1/4}	6	24	230920 11,70
Assiette plate ronde Round presentation plate Plato redondo		29 11 ^{7/16}	3	12	230921 19,50
Assiette creuse ronde Round soup/pasta bowl w/rim Plato hondo		20 7 ^{7/8}	6	12	230922 10,35
Assiette gourmet ronde petit bassin Round shallow bowl w/wide-rim Plato gourmet fondo pequeno		23 9 ^{1/16}	6	24	230923 16,50
Assiette gourmet ronde grand bassin Round shallow bowl w/wide-rim Plato gourmet fondo grande		26 10 ^{1/4}	3	12	230924 17,60
Assiette à pain ronde Round bread & butter plate Plato de pan		14 5 ^{1/2}	6	18	230918 6,50
Saladier Bowl NEW Bol	400 135 ^{1/4}	28 11	1		235223 56,70

	cl oz	cm inch	MVM	CS	€
Planche Board NEW Plancha		25 x 13,5 9 ^{13/16} x 5 ^{5/16}	1		234948 17,50
Bol biseauté cocotte Slanted rim bowl Bol biseado cocotte	7 2	7,3 2 ^{7/8}	6		230925 6,00
Bol biseauté cocotte Slanted rim bowl Bol biseado cocotte	30 10 ^{1/8}	12 4 ^{3/4}	6		230926 9,60
Bol cocotte Round casserole Bol cocotte	50 16 ^{15/16}	14 5 ^{1/2}	6		230927 11,00
Assiette/couvercle Round plate/casserole lid Bol /plato pan rondo		12,5 4 ^{15/16}	6		230928 7,70
Tasse à espresso Coffee cup Espresso taza	11 3 ^{3/4}		6		230929 6,50
Mug à thé Tea mug Tè mug	38 12 ^{7/8}		6		230930 10,30
Tasse à thé Tea cup Tè taza	20 6 ^{3/4}		6		230931 8,95

Sable rose
Pink Sand
Rosa arena



	cl oz	cm inch	MVM	CS	€
Assiette plate ronde Round dessert/salad/app. plate Plato redondo		23 9 ^{1/16}	6	24	230902 9,45
Assiette plate ronde Round dinner plate Plato redondo		26 10 ^{1/4}	6	24	230903 11,70
Assiette plate ronde Round presentation plate Plato redondo		29 11 ^{7/16}	3	12	230904 19,50
Assiette creuse ronde Round soup/pasta bowl w/rim Plato hondo		20 7 ^{7/8}	6	12	230905 10,35
Assiette gourmet ronde petit bassin Round shallow bowl w/wide-rim Plato gourmet fondo pequeno		23 9 ^{1/16}	6	24	230906 16,50
Assiette gourmet ronde grand bassin Round shallow bowl w/wide-rim Plato gourmet fondo grande		26 10 ^{1/4}	3	12	230907 17,60
Assiette à pain ronde Round bread & butter plate Plato de pan		14 5 ^{1/2}	6	18	230901 6,50

	cl oz	cm inch	MVM	CS	€
Bol biseauté cocotte Slanted rim bowl Bol biseado cocotte	7 2	7,3 2 ^{7/8}	6		230908 6,00
Bol biseauté cocotte Slanted rim bowl Bol biseado cocotte	30 10 ^{1/8}	12 4 ^{3/4}	6		230909 9,60
Bol cocotte Round casserole Bol cocotte	50 16 ^{15/16}	14 5 ^{1/2}	6		230910 11,00
Assiette/couvercle Round plate/casserole lid Bol /plato pan rondo		12,5 4 ^{15/16}	6		230911 7,70
Tasse à espresso Coffee cup Espresso taza	11 3 ^{3/4}		6		230912 6,50
Mug à thé Tea mug Tè mug	38 12 ^{7/8}		6		230913 10,30
Tasse à thé Tea cup Tè taza	20 6 ^{3/4}		6		230914 8,95



Boréal blanc

	cl - oz	cm - inch	MVM	CS	€
Assiette à pâtes ronde Round soup/pasta bowl w/wide rim Plato hondo pasta		29 11 ^{7/16}	3	12	207140 15,55
Assiette à pain ronde Round bread & butter plate Plato de pan		16 6 ^{5/16}	6	24	207139 6,30
Assiette de présentation ovale Oval presentation plate Plato presentación oval		34,5 x 29 13 ^{3/8} x 11 ^{7/16}	3	12	207137 17,55
Assiette plate ovale Oval dinner plate Plato oval		31 x 26,5 12 ^{3/16} x 10 ^{7/16}	6	12	207134 11,70
Assiette dessert ovale Oval dessert plate Plato oval		24 x 20,5 9 ^{7/16} x 8 ^{1/16}	6	18	207135 9,45
Assiette calotte ovale Oval shallow bowl, coupe Plato hondo oval		23,5 x 20 9 ^{1/4} x 7 ^{7/8}	6	12	207136 9,25

	cl - oz	cm - inch	MVM	CS	€
Plat ovale creux Oval chop plate w/rim, flat Plato hondo ovalado		26,5 x 36,5 10 ^{7/16} x 14 ^{3/8}	1		200102 34,50
Saladier Salad bowl deep Ensaladera		28 x 24 11 x 9 ^{7/16}	1		186782 34,50
Coupelle Deep bowl, small Bol		14 x 12 5 ^{1/2} x 4 ^{3/4}	6		186779 8,80
Verrine Ramekin Vaso	6 2	H 5,5 2 ^{3/16}	6		186797 3,20
Verrine Ramekin Vaso	12 4 ^{1/16}	H 7 2 ^{3/4}	6		186851 3,80
Plat à cake Oval long dish w/wide rim, flat Fuente ovalado		40,5 x 19 15 ^{15/16} x 7 ^{1/2}	1		186788 34,50

Assiette gourmet ovale grand bassin Shallow bowl w/wide oval rim Plato gourmet oval fondo grande	27 9 ^{1/8}	32x27 12 ^{5/8} x 10 ^{5/8}	3	12	204040 16,20
Assiette gourmet ovale petit bassin Shallow bowl w/wide oval rim Plato gourmet oval fondo grande	17 5 ^{3/4}	30x26 11 ^{13/16} x 10 ^{1/4}	3	12	207138 17,55
Assiette gourmet ovale bassin plat Oval plate w/wide-rim, flat Plato oval gourmet		30x26 11 ^{13/16} x 10 ^{1/4}	6	24	207141 11,70

Cloche verre borosilicate Glass dome cover Campana vidrio borosilicato		17x9 6 ^{11/16} x 3 ^{8/16}	1	24	204043 25,50
Cloche inox Dome cover, stainless steel Campana		14,8 5 ^{13/16}	1		182301 24,00
Cloche inox Dome cover, stainless steel Campana		24 9 ^{7/16}	1		182614 42,00
Bouchon porcelaine pour cloche verre Porcelain lid for dome cover Tapa de porcelana para campana de vidrio		5,2 2 ^{1/16}	6		206504 3,25



Boréal satin

	cl - oz	cm - inch	MVM	CS	€
Assiette de présentation ronde Round presentation plate w/wide rim Plato presentación		33 13	3	12	193319 24,30
Assiette plate ronde Round dinner plate w/wide rim Plato redondo		28,5 11 ^{1/4}	6	24	193318 16,60
Assiette dessert ronde Round dessert/salad/app. plate w/wide rim Plato redondo		22,5 8 ^{7/8}	6	18	193320 10,20
Assiette gourmet ovale petit bassin Shallow bowl w/wide oval rim satin finish Plato oval gourmet	17 5 ^{3/4}	30 x 26 11 ^{13/16} x 10 ^{1/4}	3	12	193324 25,80

	cl - oz	cm - inch	MVM	CS	€
Assiette gourmet ovale grand bassin Shallow bowl w/wide oval rim satin finish Plato oval gourmet	27 9 ^{1/8}	32 x 27 12 ^{5/8} x 10 ^{5/8}	3	12	207769 25,80
Assiette à pâtes/soupe ronde Round soup/pasta bowl with rim Plato hondo pasta		29 11 ^{7/16}	3	12	223954 21,50
Assiette à pain ronde Round bread & butter plate, coupe Plato pan		15 5 ^{7/8}	6	24	202470 7,60

Cocottes



Blanc White - Blanco

	cl oz	cm inch	MVM	CS	€
Assiette cocotte Casserole plate Plato cocotte	100 33 ^{13/16}	22 8 ^{11/16}	1	234342	22,00
Assiette cocotte Casserole plate Plato cocotte	70 23 ^{11/16}	18 7 ^{7/16}	1	235064	20,00
Bol cocotte Round casserole Bol cocotte	140 47 ^{5/16}	17,5 6 ^{7/8}	1	234341	22,00
Assiette/couvercle Round plate/casserole lid Bol/plato pan rondo		12,5 4 ^{15/16}	6	209384	7,70

	cl oz	cm inch	MVM	CS	€
Bol cocotte Round casserole Bol cocotte	50 16 ^{15/16}	14 5 ^{1/2}	6	209383	10,00
Bol biseauté cocotte Slanted rim bowl Bol biseado cocotte	100 33 ^{13/16}	16 6 ^{5/16}	1	234340	19,00
Bol biseauté cocotte Slanted rim bowl Bol biseado cocotte	30 10 ^{1/8}	12 4 ^{3/4}	6	186849	8,60
Bol biseauté cocotte Slanted rim bowl Bol biseado cocotte	7 2 ^{3/8}	7,3 2 ^{7/8}	6	211891	4,30

Blanc sablé - Sandy white Acabano color arena

	cl oz	cm inch	MVM	CS	€
Assiette cocotte Casserole plate Plato cocotte	100 33 ^{13/16}	22 8 ^{11/16}	1	234345	27,50
Assiette cocotte Casserole plate Plato cocotte	70 23 ^{11/16}	18 7 ^{7/16}	1	235065	26,00
Bol cocotte Round casserole Bol cocotte	140 47 ^{5/16}	17,5 6 ^{7/8}	1	234344	28,00
Assiette/couvercle Round plate/casserole lid Bol/plato pan rondo		12,5 4 ^{15/16}	6	209384	7,70

	cl oz	cm inch	MVM	CS	€
Bol cocotte Round casserole Bol cocotte	50 16 ^{15/16}	14 5 ^{1/2}	6	209720	11,00
Bol biseauté cocotte Slanted rim bowl Bol biseado cocotte	100 33 ^{13/16}	16 6 ^{5/16}	1	234343	23,00
Bol biseauté cocotte Slanted rim bowl Bol biseado cocotte	30 10 ^{1/8}	12 4 ^{3/4}	6	211893	9,60
Bol biseauté cocotte Slanted rim bowl Bol biseado cocotte	7 2 ^{3/8}	7,3 2 ^{7/8}	6	211892	5,70

Carbone - Carbone/ black - Negro

	cl oz	cm inch	MVM	CS	€
Assiette cocotte Casserole plate Plato cocotte	100 33 ^{13/16}	22 8 ^{11/16}	1	234336	27,50
Assiette cocotte Casserole plate Plato cocotte	70 23 ^{11/16}	18 7 ^{7/16}	1	235066	26,00
Bol cocotte Round casserole Bol cocotte	140 47 ^{5/16}	17,5 6 ^{7/8}	1	234335	28,00
Assiette/couvercle Round plate/casserole lid Bol/plato pan rondo		12,5 4 ^{15/16}	6	204042	7,70

	cl oz	cm inch	MVM	CS	€
Bol cocotte Round casserole Bol cocotte	50 16 ^{15/16}	14 5 ^{1/2}	6	204041	11,00
Bol biseauté cocotte Slanted rim bowl Bol biseado cocotte	100 33 ^{13/16}	16 6 ^{5/16}	1	234334	23,00
Bol biseauté cocotte Slanted rim bowl Bol biseado cocotte	30 10 ^{1/8}	12 4 ^{3/4}	6	234209	9,50
Bol biseauté cocotte Slanted rim bowl Bol biseado cocotte	7 2 ^{3/8}	7,3 2 ^{7/8}	6	234208	5,70

Bleu Blue - Azul

	cl oz	cm inch	MVM	CS	€
Assiette cocotte Casserole plate Plato cocotte	100 33 ^{13/16}	22 8 ^{11/16}	1	234339	35,00
Assiette cocotte Casserole plate Plato cocotte	70 23 ^{11/16}	18 7 ^{7/16}	1	235063	32,00
Bol cocotte Round casserole Bol cocotte	140 47 ^{5/16}	17,5 6 ^{7/8}	1	234338	36,00
Assiette/couvercle Round plate/casserole lid Bol/plato pan rondo		12,5 4 ^{15/16}	6	230820	7,70

	cl oz	cm inch	MVM	CS	€
Bol cocotte Round casserole Bol cocotte	50 16 ^{15/16}	14 5 ^{1/2}	6	230821	12,45
Bol biseauté cocotte Slanted rim bowl Bol biseado cocotte	100 33 ^{13/16}	16 6 ^{5/16}	1	234337	29,00
Bol biseauté cocotte Slanted rim bowl Bol biseado cocotte	30 10 ^{1/8}	12 4 ^{3/4}	1	230822	10,00
Bol biseauté cocotte Slanted rim bowl Bol biseado cocotte	7 2 ^{3/8}	7,3 2 ^{7/8}	6	230823	6,15



Cocottes



Onyx Onyx - Onyx **NEW**

	cl oz	cm inch	MVM	CS	€
Bol biseauté cocotte Slanted rim bowl Bol biseado cocotte	7 2	7,3 2 ^{7/8}	6	236553	6,90
Bol biseauté cocotte Slanted rim bowl Bol biseado cocotte	30 10 ^{1/8}	12 4 ^{3/4}	6	236554	10,65

	cl oz	cm inch	MVM	CS	€
Bol cocotte Round casserole Bol cocotte	50 16 ^{15/16}	14 5 ^{1/2}	6	236555	12,05
Assiette/couvercle Round plate/casserole lid Bol/plato pan rondo		12,5 4 ^{15/16}	6	236556	8,70

Basalte Brown basalt - Basalto

	cl oz	cm inch	MVM	CS	€
Bol biseauté cocotte Slanted rim bowl Bol biseado cocotte	7 2	7,3 2 ^{7/8}	6	230942	6,00
Bol biseauté cocotte Slanted rim bowl Bol biseado cocotte	30 10 ^{1/8}	12 4 ^{3/4}	6	230943	9,60

	cl oz	cm inch	MVM	CS	€
Bol cocotte Round casserole Bol cocotte	50 16 ^{15/16}	14 5 ^{1/2}	6	230944	11,00
Assiette/couvercle Round plate/casserole lid Bol/plato pan rondo		12,5 4 ^{15/16}	6	230945	7,70

Argile verte - Green clay - Arcilla verde

	cl oz	cm inch	MVM	CS	€
Bol biseauté cocotte Slanted rim bowl Bol biseado cocotte	7 2	7,3 2 ^{7/8}	6	230956	6,00
Bol biseauté cocotte Slanted rim bowl Bol biseado cocotte	30 10 ^{1/8}	12 4 ^{3/4}	6	230957	9,60

	cl oz	cm inch	MVM	CS	€
Bol cocotte Round casserole Bol cocotte	50 16 ^{15/16}	14 5 ^{1/2}	6	230958	11,00
Assiette/couvercle Round plate/casserole lid Bol/plato pan rondo		12,5 4 ^{15/16}	6	230959	7,70

Bleu de roche - Blue stone - Azul de roca

	cl oz	cm inch	MVM	CS	€
Bol biseauté cocotte Slanted rim bowl Bol biseado cocotte	7 2	7,3 2 ^{7/8}	6	230970	6,00
Bol biseauté cocotte Slanted rim bowl Bol biseado cocotte	30 10 ^{1/8}	12 4 ^{3/4}	6	230971	9,60

	cl oz	cm inch	MVM	CS	€
Bol cocotte Round casserole Bol cocotte	50 16 ^{15/16}	14 5 ^{1/2}	6	230972	11,00
Assiette/couvercle Round plate/casserole lid Bol/plato pan rondo		12,5 4 ^{15/16}	6	230973	7,70

Dune - Beige dune Beis duna

	cl oz	cm inch	MVM	CS	€
Bol biseauté cocotte Slanted rim bowl Bol biseado cocotte	7 2	7,3 2 ^{7/8}	6	230925	6,00
Bol biseauté cocotte Slanted rim bowl Bol biseado cocotte	30 10 ^{1/8}	12 4 ^{3/4}	6	230926	9,60

	cl oz	cm inch	MVM	CS	€
Bol cocotte Round casserole Bol cocotte	50 16 ^{15/16}	14 5 ^{1/2}	6	230927	11,00
Assiette/couvercle Round plate/casserole lid Bol /plato pan rondo		12,5 4 ^{15/16}	6	230928	7,70

Sable rose - Pink Sand - Rosa arena

	cl oz	cm inch	MVM	CS	€
Bol biseauté cocotte Slanted rim bowl Bol biseado cocotte	7 2	7,3 2 ^{7/8}	6	230908	6,00
Bol biseauté cocotte Slanted rim bowl Bol biseado cocotte	30 10 ^{1/8}	12 4 ^{3/4}	6	230909	9,60

	cl oz	cm inch	MVM	CS	€
Bol cocotte Round casserole Bol cocotte	50 16 ^{15/16}	14 5 ^{1/2}	6	230910	11,00
Assiette/couvercle Round plate/casserole lid Bol /plato pan rondo		12,5 4 ^{15/16}	6	230911	7,70

Collection L Couture **NEW**



	cl oz	cm inch	MVM	CS	€		cl oz	cm inch	MVM	CS	€
Assiette de présentation ronde Round presentation plate w/wide rim Plato presentación		32 12 ^{5/8}	3		237398	31,00					
Assiette plate ronde Round dinner plate w/wide rim Plato redondo		28 11	6		237399	22,50					
Assiette dessert ronde Round desert/salad plate, coupe Plato llano		24 9 ^{7/16}	6		237400	15,00					
Assiette à pain ronde Round bread & butter plate, coupe Plato de pan		14 5 ^{1/2}	6		237401	10,50					
Assiette gourmet ronde Round shallow bowl Plato redondo gourmet		30 11 ^{13/16}	3		237402	35,00					
Assiette gourmet ronde Round shallow bowl Plato redondo gourmet		28 11	3		237403	33,50					
Tasse à café Demitasse cup Taza de café	10 3 ^{3/8}		6		227828	10,50					
Soucoupe tasse à café Demitasse saucer Plato café		12,5 4 ^{15/16}	6		237404	11,50					
Tasse à thé Coffee/tea cup Taza de té	25 8 ^{7/16}		6		227829	13,10					
Soucoupe tasse à thé Tea saucer Plato té		15,8 6 ^{1/4}	6		237405	12,00					

Collection L



	cl oz	cm inch	MVM	CS	€		cl oz	cm inch	MVM	CS	€
Assiette de présentation ronde Round presentation plate w/wide rim Plato presentación		32 12 ^{5/8}	3		227822	17,50					
Assiette plate ronde Round dinner plate w/wide rim Plato redondo		28 11	6		227823	11,70					
Assiette dessert ronde Round desert/salad plate, coupe Plato llano		24 9 ^{7/16}	6		227824	9,35					
Assiette à pain ronde Round bread & butter plate, coupe Plato de pan		14 5 ^{1/2}	6		227825	7,65					
Assiette creuse calotte Round cereal plate Plato hondo		18,5 7 ^{5/16}	6		232576	9,15					
Assiette gourmet ronde Round shallow bowl Plato redondo gourmet		30 11 ^{13/16}	3		227826	20,50					
Assiette gourmet ronde Round shallow bowl Plato redondo gourmet		28 11	3		227827	20,50					
Tasse à café Demitasse cup Taza de café	10 3 ^{3/8}		6		227828	10,50					
Soucoupe tasse à café Demitasse saucer Plato café		12,5 4 ^{15/16}	6		227831	7,20					
Tasse à thé Coffee/tea cup Taza de té	25 8 ^{7/16}		6		227829	13,10					
Soucoupe tasse à thé Tea saucer Plato té		15,8 6 ^{1/4}	6		227832	8,50					



Collection L Fragment

	cl oz	cm inch	MVM	CS	€
Assiette de présentation ronde Round presentation plate w/wide rim Plato presentación		32 12 ^{5/8}	3		227843 28,50
Assiette plate ronde Round dinner plate w/wide rim Plato redondo		28 11	6		227844 20,50
Assiette dessert ronde Round desert/salad plate, coupe Plato llano		24 9 ^{7/16}	6		227845 13,50
Assiette à pain ronde Round bread & butter plate, coupe Plato de pan		14 5 ^{1/2}	6		227846 9,50
Assiette gourmet ronde Round shallow bowl Plato redondo gourmet		30 11 ^{13/16}	3		227847 32,00

	cl oz	cm inch	MVM	CS	€
Assiette gourmet ronde Round shallow bowl Plato redondo gourmet		28 11	3		227848 30,50
Tasse à café Demitasse cup Taza de café	10 3 ^{3/8}		6		227828 10,50
Soucoupe tasse à café ronde Demitasse saucer Lungo plato		12,6 4 ^{15/16}	6		227849 10,50
Tasse à thé Coffee/tea cup Taza de té	25 8 ^{7/16}		6		227829 13,10
Soucoupe tasse à thé ronde Coffe/tea saucer Lungo plato		15,8 6 ^{1/4}	6		227850 11,00



Collection L Perles de Rosée

	cl oz	cm inch	MVM	CS	€
Assiette de présentation ronde Round presentation plate w/wide rim Plato presentación		32 12 ^{5/8}	3		233922 28,30
Assiette plate ronde Round dinner plate w/wide rim Plato redondo		28 11	6		233923 20,10
Assiette dessert ronde Round desert/salad plate, coupe Plato llano		24 9 ^{7/16}	6		233924 13,40
Assiette à pain ronde Round bread & butter plate, coupe Plato de pan		14 5 ^{1/2}	6		233925 9,30
Assiette gourmet ronde Round shallow bowl Plato redondo gourmet		30 11 ^{13/16}	3		233926 31,90

	cl oz	cm inch	MVM	CS	€
Assiette gourmet ronde Round shallow bowl Plato redondo gourmet		28 11	3		233927 30,40
Tasse à café Demitasse cup Taza de café	10 3 ^{3/8}		6		227828 10,50
Soucoupe tasse à café ronde Demitasse saucer Lungo plato		12,6 4 ^{15/16}	6		233928 10,30
Tasse à thé Coffee/tea cup Taza de té	25 8 ^{7/16}		6		227829 13,10
Soucoupe tasse à thé ronde Coffe/tea saucer Lungo plato		15,8 5 ^{7/8}	6		233929 10,80



Eclipse

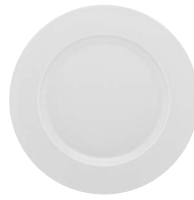

	cl oz	cm inch	MVM	CS	€
Assiette de présentation ronde Round presentation plate Plato presentación		32 12 ^{5/8}	3		234605 17,10
Assiette de présentation ronde Round presentation plate Plato presentación		30 11 ^{13/16}	3		234612 12,10
Assiette plate ronde Round dinner plate Plato redondo		26,5 10 ^{7/16}	6		234607 8,60
Assiette dessert ronde Round dessert plate Plato llano		21,5 8 ^{7/16}	6		234608 6,60
Assiette dessert ronde Round dessert plate Plato llano		18,5 7 ^{5/16}	6		234611 6,00

	cl oz	cm inch	MVM	CS	€
Assiette à pain ronde Round bread plate Plato de pan		16 6 ^{5/16}	6		234603 5,75
Assiette creuse bord à aile Round deep plate Plato hondo con aleta		22,5 8 ^{7/8}	6		234610 8,90
Assiette creuse calotte Round cereal plate Plato hondo		19 7 ^{1/2}	6		234609 6,75
Bol à salade avec aile Salad bowl with rim Bol de ensalada con aleta	17,5	17,5 6 ^{7/8}	6		234604 10,25
Plat ovale Oval dish Fuente ovalado		36,5 x 26,5 14 ^{3/8} x 10 ^{7/16}	1		234606 29,85

Essentielle



	cl oz	cm inch	MVM	CS	€
Assiette ultra plate ronde Round ultra plate Plato súper plano		25 9 ^{13/16}	6		216529 6,25
Assiette à salade ronde avec pied Footed round deep plate Plato de ensalada con pie		20 7 ^{7/8}	6		216530 7,20
Assiette ultra plate ronde Round ultra plate Plato súper plano		12 4 ^{3/4}	6		216531 3,00
Assiette oblongue Oblong plate Plato oblonga		19x32 7 ^{1/2} x 12 ^{5/8}	6		216532 11,55
Assiette oblongue Oblong plate Plato oblonga		12x20 4 ^{3/4} x 7 ^{7/8}	6		216533 5,10
Coupelle ronde avec pied Footed round deep plate Bol pequeño con pie		12 4 ^{3/4}	6		216534 3,55

	cl oz	cm inch	MVM	CS	€
Coupelle ronde avec pied Footed round deep plate Bol pequeño con pie		14 5 ^{1/2}	6		216535 3,95
Assiette à crème brûlée ronde «Crème brûlée» round plate Plato para gratinar		13,5 5 ^{5/16}	3		216536 3,95
Plat à gratin rond Round casserole plate Plato para gratinar		14 5 ^{1/2}	3		198935 4,15
Gobelet rond Round tumbler Vaso redondo		9 3 ^{9/16}	6		198936 3,15
Bol à consommé Soup bowl Bol consommé		13 5 ^{1/8}	6		198939 8,15

Graphique



	cl oz	cm inch	MVM	CS	€
Assiette de présentation ronde Round presentation plate w/wide rim Plato presentación		32 12 ^{5/8}	3	12	213936 19,90
Assiette plate ronde Round dinner plate w/wide rim Plato redondo		28 11	6	12	213938 13,30
Assiette dessert ronde Round desert/salad plate, coupe Plato llano		24 9 ^{7/16}	6	24	213940 10,60
Assiette à pain ronde Round bread & butter plate, coupe Plato de pan		14 5 ^{1/2}	6	18	213942 7,85
Assiette gourmet Round shallow bowl w/wide rim Plato oval gourmet		28 11	3	12	222365 23,40

	cl oz	cm inch	MVM	CS	€
Assiette gourmet Round shallow bowl w/wide rim Plato oval gourmet		30 11 ^{13/16}	3	12	222366 23,40
Tasse à café/espresso Demitasse cup Espresso Taza	10 3 ^{3/8}		6		207756 6,85
Soucoupe tasse à espresso ronde Demitasse saucer Espresso plato		12,5 4 ^{15/16}	6		223406 9,80
Tasse à thé/lungo Coffee/tea cup Lungo Taza	20 6 ^{3/4}		6		207757 11,20
Soucoupe lungo ronde Coffee/tea saucer Taza desayuno		15 5 ^{7/8}	6		223407 13,30



NEW La Vaisselle de l'Econome

Blanc navet
White turnip
Blanco nabo

	cl oz	cm inch	MVM	CS	€
Assiette plate ronde Round dinner plate Plato redondo		26 10 ^{1/4}	6	237318	14,00
Assiette plate ronde Round dinner plate Plato redondo		24 9 ^{7/16}	6	237317	10,80
Assiette plate ronde Round dinner plate Plato redondo		18 7 ^{7/16}	6	237316	9,15
Assiette plate ronde Round dinner plate Plato redondo		14 5 ^{1/2}	6	237315	7,50
Grande assiette creuse ronde Large deep plate Grande plato hondo	130 43 ^{15/16}	24 9 ^{7/16}	3	237324	20,80

	cl oz	cm inch	MVM	CS	€
Bol droit Straight bowl Bol derecho	260 87 ^{15/16}	24 9 ^{7/16}	1	237321	27,50
Bol droit Straight bowl Bol derecho	130 43 ^{15/16}	18 7 ^{7/16}	1	237320	14,15
Bol droit Straight bowl Bol derecho	50 16 ^{15/16}	14 5 ^{1/2}	6	237319	10,80
Bol coupe Footed bowl Bol	90 30 ^{7/16}	18 7 ^{7/16}	1	237323	14,15
Bol coupe Footed bowl Bol	47 15 ^{7/8}	14 5 ^{1/2}	6	237322	10,80

Vert artichaut
Green artichoke
Verde alcafocha

	cl oz	cm inch	MVM	CS	€
Assiette plate ronde Round dinner plate Plato redondo		26 10 ^{1/4}	6	237298	16,50
Assiette plate ronde Round dinner plate Plato redondo		24 9 ^{7/16}	6	237297	11,65
Assiette plate ronde Round dinner plate Plato redondo		18 7 ^{7/16}	6	237296	10,00
Assiette plate ronde Round dinner plate Plato redondo		14 5 ^{1/2}	6	237295	8,30
Grande assiette creuse ronde Large deep plate Grande plato hondo	130 43 ^{15/16}	24 9 ^{7/16}	3	237304	23,30

	cl oz	cm inch	MVM	CS	€
Bol droit Straight bowl Bol derecho	260 87 ^{15/16}	24 9 ^{7/16}	1	237301	30,00
Bol droit Straight bowl Bol derecho	130 43 ^{15/16}	18 7 ^{7/16}	1	237300	16,65
Bol droit Straight bowl Bol derecho	50 16 ^{15/16}	14 5 ^{1/2}	6	237299	13,30
Bol coupe Footed bowl Bol	90 30 ^{7/16}	18 7 ^{7/16}	1	237303	16,65
Bol coupe Footed bowl Bol	47 15 ^{7/8}	14 5 ^{1/2}	6	237302	13,30

Jaune gingembre
Ginger yellow
Jengibre amarillo

	cl oz	cm inch	MVM	CS	€
Assiette plate ronde Round dinner plate Plato redondo		26 10 ^{1/4}	6	237288	16,50
Assiette plate ronde Round dinner plate Plato redondo		24 9 ^{7/16}	6	237287	11,65
Assiette plate ronde Round dinner plate Plato redondo		18 7 ^{7/16}	6	237286	10,00
Assiette plate ronde Round dinner plate Plato redondo		14 5 ^{1/2}	6	237285	8,30
Grande assiette creuse ronde Large deep plate Grande plato hondo	130 43 ^{15/16}	24 9 ^{7/16}	3	237294	23,30

	cl oz	cm inch	MVM	CS	€
Bol droit Straight bowl Bol derecho	260 87 ^{15/16}	24 9 ^{7/16}	1	237291	30,00
Bol droit Straight bowl Bol derecho	130 43 ^{15/16}	18 7 ^{7/16}	1	237290	16,65
Bol droit Straight bowl Bol derecho	50 16 ^{15/16}	14 5 ^{1/2}	6	237289	13,30
Bol coupe Footed bowl Bol	90 30 ^{7/16}	18 7 ^{7/16}	1	237293	16,65
Bol coupe Footed bowl Bol	47 15 ^{7/8}	14 5 ^{1/2}	6	237292	13,30

La Vaisselle de l'Econome **NEW**



Radis rose - Pink radish

Rábano rosado

	cl oz	cm inch	MVM	CS	€
Assiette plate ronde Round dinner plate Plato redondo		26 10 ^{1/4}	6	237328	16,50
Assiette plate ronde Round dinner plate Plato redondo		24 9 ^{7/16}	6	237327	11,65
Assiette plate ronde Round dinner plate Plato redondo		18 7 ^{7/16}	6	237326	10,00
Assiette plate ronde Round dinner plate Plato redondo		14 5 ^{1/2}	6	237325	8,30
Grande assiette creuse ronde Large deep plate Grande plato hondo	130 43 ^{15/16}	24 9 ^{7/16}	3	237334	23,30

	cl oz	cm inch	MVM	CS	€
Bol droit Straight bowl Bol derecho	260 87 ^{15/16}	24 9 ^{7/16}	1	237331	30,00
Bol droit Straight bowl Bol derecho	130 43 ^{15/16}	18 7 ^{7/16}	1	237330	16,65
Bol droit Straight bowl Bol derecho	50 16 ^{15/16}	14 5 ^{1/2}	6	237329	13,30
Bol coupe Footed bowl Bol	90 30 ^{7/16}	18 7 ^{7/16}	1	237333	16,65
Bol coupe Footed bowl Bol	47 15 ^{7/8}	14 5 ^{1/2}	6	237332	13,30

Gris rutabaga
Grey rutabaga
Colinabo gris

	cl oz	cm inch	MVM	CS	€
Assiette plate ronde Round dinner plate Plato redondo		26 10 ^{1/4}	6	237308	16,50
Assiette plate ronde Round dinner plate Plato redondo		24 9 ^{7/16}	6	237307	11,65
Assiette plate ronde Round dinner plate Plato redondo		18 7 ^{7/16}	6	237306	10,00
Assiette plate ronde Round dinner plate Plato redondo		14 5 ^{1/2}	6	237305	8,30
Grande assiette creuse ronde Large deep plate Grande plato hondo	130 43 ^{15/16}	24 9 ^{7/16}	3	237314	23,30

	cl oz	cm inch	MVM	CS	€
Bol droit Straight bowl Bol derecho	260 87 ^{15/16}	24 9 ^{7/16}	1	237311	30,00
Bol droit Straight bowl Bol derecho	130 43 ^{15/16}	18 7 ^{7/16}	1	237310	16,65
Bol droit Straight bowl Bol derecho	50 16 ^{15/16}	14 5 ^{1/2}	6	237309	13,30
Bol coupe Footed bowl Bol	90 30 ^{7/16}	18 7 ^{7/16}	1	237313	16,65
Bol coupe Footed bowl Bol	47 15 ^{7/8}	14 5 ^{1/2}	6	237312	13,30

	cl oz	cm inch	MVM	CS	€
Centre de table rond Round center dish Centro de mesa		28 11	1	237337	45,80





Modulo

	cl oz	cm inch	MVM	CS	€		cl oz	cm inch	MVM	CS	€
Assiette de présentation ronde Round presentation coupe plate Plato presentación		32 12 ^{5/8}	3	12	207120	13,35					
Assiette plate ronde Round dinner coupe plate Plato redondo		29 11 ^{7/16}	6	24	207112	11,09		32 12 ^{5/8}	1		136524 21,13
Assiette plate ronde Round dinner coupe plate Plato redondo		26 10 ^{1/4}	6	24	207113	6,59					
Assiette plate ronde Round dinner coupe plate NEW Plato redondo		24 9 ^{7/16}	6	24	239142	6,30					
Assiette dessert ronde Round dessert/salad/app. coupe plate Plato redondo		20 7 ^{7/8}	6	18	207111	5,76					
Assiette creuse calotte Round shallow bowl Plato hondo		20 7 ^{7/8}	6	12	207114	6,59					
Assiette à pain ronde Round bread & butter coupe plate Plato de pan		15 5 ^{7/8}	6	24	207119	5,69					
Assiette de présentation carrée Square presentation coupe plate Plato presentación		28 x 28 11 x 11	3	12	207118	17,54					
Assiette plate carrée Square dinner coupe plate Plato cuadrado		24 x 24 9 ^{7/16} x 9 ^{7/16}	6	24	207115	9,26					
Assiette dessert carrée Square dessert/salad/app. coupe plate Plato cuadrado		20 x 20 7 ^{7/8} x 7 ^{7/8}	6	18	207117	8,10					
Assiette creuse carrée Square soup/salad, coupe plate Plato hondo cuadrado		20 x 20 7 ^{7/8} x 7 ^{7/8}	6	12	207116	8,17					
Assiette à pain carrée Square bread & butter coupe plate Plato de pan cuadrado		14 x 14 5 ^{1/2} x 5 ^{1/2}	6	24	207123	6,71					
Plat creux carré Square deep dish, coupe Plato hondo cuadrado		28 x 28 11 x 11	1		149831	40,61					
Plat creux carré Square deep dish, coupe Plato hondo cuadrado		16 x 16 6 ^{5/16} x 6 ^{5/16}	1		154244	14,51					
Assiette de présentation rectangle Rectangular presentation coupe plate Plato rectangular		34 x 26 13 ^{3/8} x 10 ^{1/4}	3	12	181485	18,39					
Assiette plate rectangle Rectangular dinner coupe plate Plato rectangular		30 x 22 11 ^{13/16} x 8 ^{11/16}	6	12	207122	10,41					
Assiette dessert rectangle Rectangular dessert/salad/app. coupe plate Plato rectangular		26 x 18 10 ^{1/4} x 7 ^{1/16}	6	18	207110	9,17					
Plat rectangulaire Rectangular dish, underliner Plato rectangular		20 x 12 7 ^{7/8} x 4 ^{3/4}	1		207753	8,11					
Plat rectangulaire Rectangular dish, coupe large Plato rectangular		40 x 16 15 ^{3/4} x 6 ^{5/16}	1		207754	23,25					
Verrine porcelaine Ramekin, porcelain Vasito porcelana	8 2 ^{11/16}		6	24	181490	2,58					
Coffret salière & poivrière Salt & pepper cruet Salero y pimentero									1	24	182915 15,19
Plat à tarte Pie/pizza plate, flat Fuente para pastel								32 12 ^{5/8}	1		136524 21,13
Bol Deep bowl, large Bol hondo	250 84 ^{9/16}	28 11	1						1		142722 38,05
Bol Deep bowl, medium Bol hondo	200 67 ^{5/8}	24 9 ^{7/16}	1						1		136529 24,48
Bol Deep bowl, medium Bol hondo	130 43 ^{15/16}	20 7 ^{7/8}	1						1		136511 17,06
Bol Deep bowl, individual Bol hondo	67 22 ^{5/8}	16 6 ^{5/16}	1						1		136528 9,65
Bol Deep bowl, soup Bol hondo	55 18 ^{5/8}	14 5 ^{1/2}	6						6		154245 8,31
Bol Med bowl, soup Bol hondo	48 16	13 5 ^{1/8}	6						6		188537 7,04
Bol Deep bowl, rice Bol hondo	27 9 ^{1/8}	12 4 ^{3/4}	6	24					6	24	136510 5,76
Bol Deep bowl, ramekin Bol hondo	8 3 ^{1/8}	8 3 ^{1/8}	6	24					6	24	136509 3,52
Bol carré Square bowl deep Bol cuadrado hondo	350 13 ^{3/8}	12 x 12 4 ^{3/4} x 4 ^{3/4}	6						6		181483 6,25
Coupe ronde Round pasta/salad/seafood bowl, footed Bol	11 4 ^{1/4}	24 9 ^{7/16}	1						1		136535 18,48
Coupe ronde Round shallow bowl, footed Bol	75 2 ^{15/16}	16 6 ^{5/16}	6						6		136532 7,64
Coupe ronde Round shallow bowl, footed Bol	250 1	8 3 ^{1/8}	6						6		136530 3,52
Coupe carrée Square bowl, footed coupe Bol cuadrado	35 1 ^{5/8}	12 x 12 4 ^{3/4} x 4 ^{3/4}	6						6		136502 6,25
Coupe carrée Square bowl, footed coupe Bol cuadrado	25 1	8 x 8 3 ^{1/8} x 3 ^{1/8}	6						6		136503 4,60
Bol conique Conic bowl Bol cónico	115 38 ^{7/8}		1						1		233842 10,00
Bol conique Conic bowl Bol cónico	30 10 ^{1/8}		1						1		233841 7,10
Présentoir à gâteaux rond Round app/pizza/presentation stand Expositor de tartas	105 4 ^{1/4}	32 12 ^{5/8}	1						1		209382 36,03
Présentoir à gâteaux rond Round app/pizza/presentation stand Expositor de tartas	85 2 ^{3/16}	25 9 ^{13/16}	1						1		209381 21,62

Modulo color



Gris perle

Light grey - Gris perla

	cl oz	cm inch	MVM	CS	€
Bol Bowl, large Bol	200 67 ^{5/8}	24 9 ^{7/16}	1		230142 31,50
Bol Bowl, medium Bol hondo	130 43 ^{15/16}	20 7 ^{7/8}	1		230141 20,20
Bol Bowl, medium Bol hondo	67 22 ^{5/8}	16 6 ^{5/16}	1		230140 14,10

	cl oz	cm inch	MVM	CS	€
Bol à déjeuner Bowl, individual Bol hondo	55 18 ^{5/8}	14 5 ^{1/2}	6		230139 12,00
Bol à thé Bowl, small Bol hondo	20 6 ^{3/4}	9 3 ^{9/16}	6	24	230138 4,75

Modulo Nature



Bleu galet

Blue - Azul

	cl oz	cm inch	MVM	CS	€
Plat/assiette de présentation Round presentation plate, coupe Plato presentación		31,5 12 ^{3/8}	3	6	225342 20,00
Assiette plate ronde Round dinner plate, coupe Plato redondo		28 11	6	24	225343 8,90
Assiette dessert ronde Round desert/salad plate, coupe Plato llano		21 8 ^{1/4}	6	18	225344 8,50
Assiette calotte ronde Round salad/cereal plate Plato hondo		21 8 ^{1/4}	6	12	225345 7,50
Assiette à pain ronde Round bread & butter plate, coupe Plato de pan		16 6 ^{5/16}	6	24	225353 6,20
Saladier Salad bowl, deep Ensaladera		24 9 ^{7/16}	1	6	225349 30,00

	cl oz	cm inch	MVM	CS	€
Coupe Small bowl, cup Bol pequeño		10 3 ^{15/16}	6	24	225346 6,20
Coupe/calotte Salad/cereal plate, deep Bol		17,7 6 ^{15/16}	6	12	225347 7,95
Tasse à café Demitasse cup Taza de café	11,5 3 ^{7/8}		6	24	225351 5,30
Soucoupe tasse à café Demitasse saucer Plato café		12,5 4 ^{15/16}	6	24	225352 4,40
Tasse à thé Coffee/tea cup Taza de té	25 8 ^{7/16}		6	24	230167 6,20
Soucoupe tasse à thé Coffe/tea saucer Plato té		15 5 ^{7/8}	6	24	230168 5,50



Modulo Nature



Kaolin

Kaolin - Kaolin

	cl oz	cm inch	MVM	CS	€	
Plat/assiette de présentation Round presentation plate, coupe Plato presentación		31,5 12 ^{3/8}	3	6	184088	20,00
Assiette plate ronde Round dinner plate, coupe Plato redondo		28 11	6	24	184077	8,90
Assiette dessert ronde Round desert/salad plate, coupe Plato llano		21 8 ^{1/4}	6	18	184078	8,50
Coupe ronde Round cup Bol		25 9 ^{13/16}	1		234449	12,00
Assiette calotte ronde Round salad/cereal plate Plato hondo		21 8 ^{1/4}	6	12	184079	7,50
Assiette à pain ronde Round bread & butter plate, coupe Plato de pan		16 6 ^{5/16}	6	24	209092	6,20
Saladier Salad bowl, deep Ensaladera		24 9 ^{7/16}	1	6	184087	30,00
Mug Mug Mug	33 11 ^{3/16}		6	24	184083	8,60

	cl oz	cm inch	MVM	CS	€	
Bol à déjeuner Soup/breakfast bowl Bol desayuno	58 19 ^{5/8}	14 5 ^{1/2}	6	24	184084	5,70
Coupelle Small bowl, cup Bol pequeño		10 3 ^{15/16}	6	24	184085	6,20
Coupe/calotte Salad/cereal plate, deep Bol		17,7 6 ^{15/16}	6	12	184086	7,95
Tasse à café Demitasse cup Taza de café	11,5 3 ^{7/8}		6	24	184081	5,30
Soucoupe tasse à café Demitasse saucer Plato café		12,5 4 ^{15/16}	6	24	184082	4,40
Tasse à thé Coffee/tea cup Taza de té	25 8 ^{7/16}		6	24	230163	6,20
Soucoupe tasse à thé Coffe/tea saucer Plato té		15 5 ^{7/8}	6	24	230164	5,50



Terre d'ombre

Warm grey - Tierra

	cl oz	cm inch	MVM	CS	€	
Plat/assiette de présentation Round presentation plate, coupe Plato presentación		31,5 12 ^{3/8}	3	6	184101	20,00
Assiette plate ronde Round dinner plate, coupe Plato redondo		28 11	6	24	184090	8,90
Assiette dessert ronde Round desert/salad plate, coupe Plato llano		21 8 ^{1/4}	6	18	184091	8,50
Coupe ronde Round cup Bol		25 9 ^{13/16}	1	12	234451	12,00
Assiette calotte ronde Round salad/cereal plate Plato hondo		21 8 ^{1/4}	6	12	184092	7,50
Assiette à pain ronde Round bread & butter plate, coupe Plato de pan		16 6 ^{5/16}	6	24	209093	6,20
Saladier Salad bowl, deep Ensaladera		24 9 ^{7/16}	1	6	184100	30,00
Mug Mug Mug	33 11 ^{3/16}		6	24	184096	8,60

	cl oz	cm inch	MVM	CS	€	
Bol à déjeuner Soup/breakfast bowl Bol desayuno	58 19 ^{5/8}	14 5 ^{1/2}	6	24	184097	5,70
Coupelle Small bowl, cup Bol pequeño		10 3 ^{15/16}	6	24	184098	6,20
Coupe/calotte Salad/cereal plate, deep Bol		17,7 6 ^{15/16}	6	12	184099	7,95
Tasse à café Demitasse cup Taza de café	11,5 3 ^{7/8}		6	24	184094	5,30
Soucoupe tasse à café Demitasse saucer Plato café		12,5 4 ^{15/16}	6	24	184095	4,40
Tasse à thé Coffee/tea cup Taza de té	25 8 ^{7/16}		6	24	230165	6,20
Soucoupe tasse à thé Coffe/tea saucer Plato té		15 5 ^{7/8}	6	24	230166	5,50



Modulo Nature

Pierre de lave - Lava

stone - Piedra de Lava



	cl oz	cm inch	MVM	CS	€		cl oz	cm inch	MVM	CS	€
Plat/assiette de présentation Round presentation plate, coupe Plato presentación		31,5 12 ^{3/8}	3	6	194455	20,00					
Assiette plate ronde Round dinner plate, coupe Plato redondo		28 11	6	24	194454	8,90					
Assiette dessert ronde Round desert/salad plate, coupe Plato llano		21 8 ^{1/4}	6	18	194453	8,50					
Coupe ronde Round cup Bol		25 9 ^{13/16}	1		234455	12,00					
Assiette calotte ronde Round salad/cereal plate Plato hondo		21 8 ^{1/4}	6	12	194452	7,50					
Assiette à pain ronde Round bread & butter plate, coupe Plato de pan		16 6 ^{5/16}	6	24	230092	6,20					
Saladier Salad bowl, deep Ensaladera		24 9 ^{7/16}	1	6	194462	30,00					
Mug Mug Mug	33 11 ^{3/16}		6	24	194461	8,60					
Bol à déjeuner Soup/breakfast bowl Bol desayuno	58 19 ^{5/8}	14 5 ^{1/2}	6	24	194456	5,70					
Coupelle Small bowl, cup Bol pequeño		10 3 ^{15/16}	6	24	194458	6,20					
Coupe/calotte Salad/cereal plate, deep Bol		17,7 6 ^{15/16}	6	12	194457	7,95					
Tasse à café Demitasse cup Taza de café	11,5 3 ^{7/8}		6	24	194459	5,30					
Soucoupe tasse à café Demitasse saucer Plato café		12,5 4 ^{15/16}	6	24	194460	4,40					
Tasse à thé Coffee/tea cup Taza de té	25 8 ^{7/16}		6	24	230093	6,20					
Soucoupe tasse à thé Tea saucer Plato té		15 5 ^{7/8}	6	24	230094	5,50					

Mondo

Bleu indigo

Indigo Blue

Azul añil



	cl oz	cm inch	MVM	CS	€		cl oz	cm inch	MVM	CS	€
Assiette plate ronde Round dinner plate Plato redondo		26 10 ^{1/4}	6		233993	10,40					
Assiette à partager ronde Round shared plate Plato para compartir		20 7 ^{7/8}	1		233995	9,40					
Grande assiette creuse ronde Round large deep plate Grande plato llano	100 33 ^{13/16}	22,5 8 ^{7/8}	6		233996	11,40					
Bol Bowl Bol	110 37 ^{3/16}	19 7 ^{1/2}	6		233997	11,40					
Coupelle ronde Round small bowl Bol pequeño	33 11 ^{3/16}	12,5 4 ^{15/16}	6		233999	7,30					



Mondo

Cristaux de sel
Salt white
Cristales de sal



	cl oz	cm inch	MVM	CS	€
Assiette plate ronde Round dinner plate Plato redondo		26 10 ^{1/4}	6	233987	10,40
Assiette à partager ronde Round shared plate Plato para compartir		20 7 ^{7/8}	1	233989	9,40
Grande assiette creuse ronde Round large deep plate Grande plato llano	100 33 ^{13/16}	22,5 8 ^{7/8}	6	233990	11,40

	cl oz	cm inch	MVM	CS	€
Bol Bowl Bol	110 37 ^{3/16}	19 7 ^{1/2}	6	233991	11,40
Coupelle ronde Round small bowl Bol pequeño	33 11 ^{3/16}	12,5 4 ^{15/16}	6	233992	7,30

Rouge piment
Red chili
Rojo pimienta



	cl oz	cm inch	MVM	CS	€
Assiette plate ronde Round dinner plate Plato redondo		26 10 ^{1/4}	6	234842	10,40
Assiette à partager ronde Round shared plate Plato para compartir		20 7 ^{7/8}	1	234843	9,40
Grande assiette creuse ronde Round large deep plate Grande plato llano	100 33 ^{13/16}	22,5 8 ^{7/8}	6	234844	11,40

	cl oz	cm inch	MVM	CS	€
Bol Bowl Bol	110 37 ^{3/16}	19 7 ^{1/2}	6	234845	11,40
Coupelle ronde Round small bowl Bol pequeño	33 11 ^{3/16}	12,5 4 ^{15/16}	6	234846	7,30

Vert shisho
Shisho green
Verde shisho



	cl oz	cm inch	MVM	CS	€
Assiette plate ronde Round dinner plate Plato redondo		26 10 ^{1/4}	6	234000	10,40
Assiette à partager ronde Round shared plate Plato para compartir		20 7 ^{7/8}	1	234002	9,40
Grande assiette creuse ronde Round large deep plate Grande plato llano	100 33 ^{13/16}	22,5 8 ^{7/8}	6	234003	11,40

	cl oz	cm inch	MVM	CS	€
Bol Bowl Bol	110 37 ^{3/16}	19 7 ^{1/2}	6	234004	11,40
Coupelle ronde Round small bowl Bol pequeño	33 11 ^{3/16}	12,5 4 ^{15/16}	6	234005	7,30

Newcook modulo



	cl oz	cm inch	MVM	CS	€
Ramekin Ramekin Ramekin		9,5 3 ^{3/4}	1		162015 7,15
Bol à consommé Soup bowl Bol consomé	50 16 ^{15/16}	10,5 4 ^{1/8}	1		162013 10,65

	cl oz	cm inch	MVM	CS	€
Assiette à crème brûlée «Crème brûlée» dish Plato para gratinar		14 5 ^{1/2}	1		162011 10,65
Plat à escargots 6 places Snail tray 6 spaces Bandeja caracoles 6 compartimentos		16,6 x 11,2 6 ^{9/16} x 4 ^{7/16}	6		164138 7,15

Newport



	cl - oz	cm - inch	MVM	CS	€
Tasse à café/espresso Demitasse cup Espresso Taza	10 3 ^{3/8}		6		207756 6,85
Soucoupe tasse à café/espresso Demitasse saucer Espresso Plato		12,5 4 ^{5/16}	6		207759 5,65
Tasse à thé/lungo Coffee/tea cup Lungo Taza	20 6 ^{3/4}		6		207757 11,20
Soucoupe tasse à thé/lungo Coffee/tea saucer Taza desayuno		15,8 5 ^{7/8}	6		207760 7,50
Tasse à déjeuner Breakfast cup Taza desayuno	40 13 ^{1/2}		6		207758 13,40
Soucoupe tasse à déjeuner Breakfast saucer Plato desayuno		19 7 ^{1/2}	6		207761 8,90

	cl - oz	cm - inch	MVM	CS	€
Crémier Cream jug Lechera	10 3 ^{3/8}		1		207762 18,65
Verseuse Tea pot Tetera	40 13 ^{1/2}		1		207763 61,20
Verseuse Tea pot Tetera	80 27 ^{1/16}		1		207764 81,60
Couvercle verseuse 40cl Lid for tea pot Tapa cafetera	40 13 ^{1/2}	6,7 2 ^{5/8}	1		210911 23,20
Couvercle verseuse 80cl Lid for tea pot Tapa cafetera	80 27 ^{1/16}	8,4 3 ^{5/16}	1		210912 32,60



Salam



Blanc White - Blanco

	cl oz	cm inch	MVM	CS	€
Théière 2 tasses feutre noir Salam tea pot 2 cups Tetera 2 tazas	35 11 ¹³ / ₁₆		1	12	211987 60,65
Théière 4 tasses feutre noir Salam tea pot 4 cups Tetera 4 tazas	70 23 ¹¹ / ₁₆		1	4	211988 70,80
Théière 6 tasses feutre noir Salam tea pot 6 cups Tetera 6 tazas	100 33 ¹³ / ₁₆		1	6	211989 80,10
Théière 8 tasses feutre noir Salam tea pot 8 cups Tetera 8 tazas	130 43 ¹⁵ / ₁₆		1	4	211990 89,65
Corps théière 2 tasses Tea pot 2 cups without lid Cuerpo tetera 2 tazas	35 11 ¹³ / ₁₆		1	12	189946 30,00
Corps théière 4 tasses Tea pot 4 cups without lid Cuerpo tetera 4 tazas	70 23 ¹¹ / ₁₆		1	4	189947 35,00
Corps théière 6 tasses Tea pot 6 cups without lid Cuerpo tetera 6 tazas	100 33 ¹³ / ₁₆		1	6	189948 40,00

	cl oz	cm inch	MVM	CS	€
Corps théière 8 tasses Tea pot 8 cups without lid Cuerpo tetera 8 tazas	130 43 ¹⁵ / ₁₆		1	4	189949 45,00
Sucrier Sugar bowl Azucarero con tapa	28 9 ⁷ / ₁₆		1		187276 29,00
Corps sucrier Sugar bowl without lid Azucarero	28 9 ⁷ / ₁₆		1		187283 15,00
Crémier Cream jug Lechera	15 5 ¹ / ₁₆		6		187277 11,50
Bouchon porcelaine théière 2/4 T Porcelain lid for tea pot 2/4 C Tirador porcelana por tetera 2/4 T			6		205135 7,00
Bouchon porcelaine théière 6/8 T Porcelain lid for tea pot 6/8 C Tirador porcelana por tetera 6/8 T			6		205136 9,00



Salam

Noir mat Mat black - Negro mate

	cl oz	cm inch	MVM	CS	€
Théière 2 tasses feutre noir Salam tea pot 2 cups Tetera 2 tazas	35 11 ¹³ / ₁₆		1	12	211991 60,65
Théière 4 tasses feutre noir Salam tea pot 4 cups Tetera 4 tazas	70 23 ¹¹ / ₁₆		1	4	211992 74,15
Théière 6 tasses feutre noir Salam tea pot 6 cups Tetera 6 tazas	100 33 ¹³ / ₁₆		1	6	211993 87,65
Théière 8 tasses feutre noir Salam tea pot 8 cups Tetera 8 tazas	130 43 ¹⁵ / ₁₆		1	4	211994 97,00
Corps théière 2 tasses Tea pot 2 cups without lid Cuerpo tetera 2 tazas	35 11 ¹³ / ₁₆		1		150450 30,00
Corps théière 4 tasses Tea pot 4 cups without lid Cuerpo tetera 4 tazas	70 23 ¹¹ / ₁₆		1		150455 37,00
Corps théière 6 tasses Tea pot 6 cups without lid Cuerpo tetera 6 tazas	100 33 ¹³ / ₁₆		1		150456 44,00

	cl oz	cm inch	MVM	CS	€
Corps théière 8 tasses Tea pot 8 cups without lid Cuerpo tetera 8 tazas	130 43 ¹⁵ / ₁₆		1		150447 49,00
Sucrier Sugar bowl Azucarero con tapa	28 9 ⁷ / ₁₆		1		150475 30,00
Corps sucrier Sugar bowl without lid Azucarero	28 9 ⁷ / ₁₆		1		150469 15,50
Crémier Cream jug Lechera	15 5 ¹ / ₁₆		6		150485 12,50
Bouchon porcelaine théière 2/4 T Porcelain lid for tea pot 2/4 C Tirador porcelana por tetera 2/4 T			6		210575 7,80
Bouchon porcelaine théière 6/8 T Porcelain lid for tea pot 6/8 C Tirador porcelana por tetera 6/8 T			6		210576 9,70

Salam Black



Noir - Black - Negro

	cl oz	cm inch	MVM	CS	€
Théière 4 tasses feutre noir cloche alu black Salam tea pot 4 cups w/black color lid Tetera campana aluminio 4 tazas black	70 23 ^{11/16}		1	4	216410 74,15
Théière 6 tasses feutre noir cloche alu black Salam tea pot 6 cups w/black color lid Tetera campana aluminio 6 tazas black	100 33 ^{13/16}		1	6	216414 87,65

Salam Color



	cl oz	cm inch	MVM	CS	€
Théière 4 tasses feutre noir cloche alu bronze Salam tea pot 4 cups w/bronze color lid Tetera campana aluminio 4 tazas bronze	70 23 ^{11/16}		1	4	216411 74,00
Théière 4 tasses feutre noir cloche alu zinc Salam tea pot 4 cups w/zinc color lid Tetera campana aluminio 4 tazas cinc	70 23 ^{11/16}		1	4	216412 74,00
Théière 4 tasses feutre noir cloche alu bleue Salam tea pot 4 cups w/blue color lid Tetera campana aluminio 4 tazas azul	70 23 ^{11/16}		1	4	225358 74,00
Théière 4 tasses cloche alu dorée Salam tea pot 4 cups gold aluminium lid Tetera 4 tazas campana dorado aluminio	70 23 ^{11/16}		1	4	234216 129,00
Théière 6 tasses feutre noir cloche alu bronze Salam tea pot 6 cups w/bronze color lid Tetera campana aluminio 6 tazas bronze	100 33 ^{13/16}		1	6	216415 87,50
Théière 6 tasses feutre noir cloche alu zinc Salam tea pot 6 cups w/zinc color lid Tetera campana aluminio 6 tazas cinc	100 33 ^{13/16}		1	6	216416 87,50
Théière 6 tasses feutre noir cloche alu bleue Salam tea pot 6 cups w/blue color lid Tetera campana aluminio 6 tazas azul	100 33 ^{13/16}		1	6	225359 87,50
Théière 6 tasses cloche alu dorée Salam tea pot 6 cups gold aluminium lid Tetera 6 tazas campana dorado aluminio	100 33 ^{13/16}		1	6	234217 139,00

Accessoires - Accessories Accessori

	cl oz	cm inch	MVM	CS	€		cl oz	cm inch	MVM	CS	€
Feutre noir pour théière 2 tasses Tea pot felt 2 cups Filtro aislante tetera 2 tazas			1	217130	5,20	Infuseur 2 tasses Stainless steel filter 2 cups Filtro Tetera 2 tazas			1	147992	7,20
Feutre noir pour théière 4 tasses Tea pot felt 4 cups Filtro aislante tetera 4 tazas			1	217131	5,70	Infuseur 4 tasses Stainless steel filter 4 cups Filtro Tetera 4 tazas			1	147994	8,45
Feutre noir pour théière 6 tasses Tea pot felt 6 cups Filtro aislante tetera 6 tazas			1	217132	6,50	Infuseur 6/8 tasses Stainless steel filter 6/8 cups Filtro Tetera 6/8 tazas			1	147993	9,85
Feutre noir pour théière 8 tasses Tea pot felt 8 cups Filtro aislante tetera 8 tazas			1	217133	7,50						



Salam Thé

Blanc White - Blanco	cl oz	cm inch	MVM	CS	€		cl oz	cm inch	MVM	CS	€
Tasse à café Demitasse cup Taza de café	11 3 ^{3/4}		6	210946	5,60	Mug à thé Tea mug Mug	38 12 ^{7/8}		6	210949	8,25
Tasse à thé Coffee/tea cup Taza de té	25 8 ^{7/16}		6	210947	6,85	Soucoupe tasse à café/thé Demitasse/coffee/tea saucer Plato café/té	16 6 ^{5/16}	6	210950	4,10	
Tasse à déjeuner Breakfast cup Taza desayuno	42 14 ^{3/16}		6	210948	8,50	Soucoupe tasse à déjeuner/mug Breakfast/mug saucer Plato desayuno/mug	18 7 ^{1/16}	6	210951	5,15	

Gris perle Light grey Gris Perla



	cl oz	cm inch	MVM	CS	€		cl oz	cm inch	MVM	CS	€
Tasse à café Demitasse cup Taza de café	11 3 ^{3/4}		6	230145	6,00	Tasse à déjeuner Breakfast cup Taza desayuno	42 14 ^{3/16}		6	230147	9,10
Tasse à thé Coffee/tea cup Taza de té	25 8 ^{7/16}		6	230146	7,35	Mug à thé Tea mug Mug	38 12 ^{7/8}		6	230148	8,90

Thé rose poudre Light pink Rosa claro



	cl oz	cm inch	MVM	CS	€		cl oz	cm inch	MVM	CS	€
Tasse à café Demitasse cup Taza de café	11 3 ^{3/4}		6	230130	6,00	Tasse à déjeuner Breakfast cup Taza desayuno	42 14 ^{3/16}		6	230132	9,10
Tasse à thé Coffee/tea cup Taza de té	25 8 ^{7/16}		6	230131	7,35	Mug à thé Tea mug Mug	38 12 ^{7/8}		6	230133	8,90

Smoos



	cl oz	cm inch	MVM	CS	€		cl oz	cm inch	MVM	CS	€
Assiette plate Presentation plate Plato presentacion		28 11	6	24	161009	10,50					
Assiette plate Dinner plate Plato		24 9 ^{7/16}	6	24	161008	8,40					
Assiette plate Bread & butter plate Plato redondo		16 6 ^{5/16}	6	24	161038	7,50					
Assiette creuse Shallow coupe bow, medium Plato hondo		23 9 ^{1/16}	6	12	161011	12,10					
Assiette creuse Shallow coupe bow, large Plato hondo		30 11 ^{13/16}	3		161012	17,50					
Saladier Salad bowl, Large Ensaladera	250 84 ^{9/16}	32 12 ^{5/8}	1		161016	45,80					
Saladier Salad bowl, medium Ensaladera	150 50 ^{3/4}	25 9 ^{13/16}	1		161015	29,90					
Saladier/bol Salad bowl, individual Bol	50 16 ^{15/16}	16,5 6 ^{1/2}	6		161014	12,60					
Saladier Deep bowl, cup Bol	20 6 ^{3/4}	9 3 ^{9/16}	6		161013	8,30					
Ravier Shallow ramekin, coupe Bol		10 3 ^{15/16}	6		161037	6,80					
Coquetier Egg cup, plate Huevera		ø 15 ø 5 ^{7/8}	6		161020	7,25					
Support plateau Tray stand, 3 places Fuente con 3 espacios rectangular		30,5 x 10 12 x 3 ^{15/16}	1		161036	14,50					
Pot à sauce/garniture Ramekin, small Pot	7,5 2 ^{9/16}	5,5 2 ^{3/16}	6		196561	4,15					
Pot à sauce/garniture Ramekin/sugar bowl Pot	20 6 ^{3/4}	8 3 ^{1/8}	6		198016	5,95					
Pot à sauce/garniture Ramekin, large Pot	48 16 ^{1/4}	10,5 4 ^{1/8}	6		198017	9,40					



	cl oz	cm inch	MVM	CS	€		cl oz	cm inch	MVM	CS	€
Tasse à espresso Espresso cup Espresso Taza	6 2		6		207766	4,15					
Tasse à café Demitasse cup Taza de café	11 3 ^{3/4}		6		208948	5,00					
Soucoupe tasse à café/espresso Demitasse/espresso saucer Plato espresso		15 5 ^{7/8}	6		161025	5,10					
Tasse à thé/lungo Coffee/tea cup Lungo taza	20 6 ^{3/4}		6		207767	5,95					
Soucoupe tasse à thé/lungo Coffee/tea saucer Taza desayuno		18 7 ^{1/16}	6		161028	6,00					
Tasse à déjeuner Breakfast cup Taza desayuno	48 16 ^{1/4}		6		207768	8,65					
Soucoupe tasse à déjeuner Breakfast saucer Plato desayuno		21 8 ^{1/4}	6		161034	7,80					
Mug Mug Mug	30 10 ^{1/8}		6		209189	7,80					
Mug XL Mug large Mug XL	50 16 ^{15/16}		6		207765	8,65					
Soucoupe ronde Round saucer cup Plato universal		13 5 ^{1/8}	6		214688	3,26					



DEGRENE
PARIS



PLATERIE
HOLLOWARE
ORFEBRERIA

Accessoires

accessories - accesorios



Miroir - mirror - brillo

	cm - inch	MVM	CS	€		cm - inch	MVM	CS	€	
Cloche assiette Dome cover, stainless steel Campana	ø 14,8 ø 5 ^{13/16}	1	182301	24,00	Pince à pain Bread tong Pinzas pan	23 9 ^{1/16}	1	12	204498	18,40
Cloche assiette Dome cover Campana	ø 22 ø 8 ^{7/8}	1	10 044112	40,50	Pince à homard Lobster craker Tenacillas para bogavante	18,5 7 ^{5/16}	1		204497	50,95
Cloche assiette Dome cover, stainless steel Campana	ø 24 ø 9 ^{7/16}	1	16 182614	42,00	Pince à crustacé Seafood cracker Tenacillas para crustáceos	16,5 6 ^{1/2}	1		184492	11,90
Cloche assiette Dome cover Campana	ø 26 ø 10 ^{1/4}	1	20 044113	42,00	Pince à servir Serving tong Pinzas para servir	29,5 11 ^{5/8}	1	25	204499	26,90
Corbeille à pain ronde en fil Round break basket Panera redonda	ø 17,5/h 6 ø 6 ^{7/8} /h 2 ^{3/8}	1	24 128910	24,75	Ciseaux à gâteaux Pastry scissors/tong Pinzas para pasteles	20 7 ^{7/8}	1		204496	50,40
Corbeille à pain ronde en fil Round break basket Panera redonda	ø 20,5/h 7,5 ø 8 ^{1/16} /h 2 ^{15/16}	1	18 120522	26,75	Cuillère à toast Appetizer spoon Cuchara aperitivo	11,8 7 ^{7/16}	1	50	130994	2,60
Corbeille à pain ovale en fil Oval break basket Panera ovalada	ø 20 x 15/h 6 ø 7 ^{7/8} x5 ^{7/8} /h 2 ^{3/8}	1	24 128911	24,75	Pince à glace Ice tong Pinzas para hielo	16 6 ^{5/16}	1	40	004014	4,05
Corbeille à pain ovale en fil Oval break basket Panera ovalada	ø 24 x 17/h 7,5 ø 9 ^{7/16} x6 ^{11/16} /h 2 ^{15/16}	1	18 128912	29,00	Pince à sucre Sugar tong Pinzas para azúcar	11,5 4 ^{1/2}	1		002191	4,15
Bol rince doigts Finger bowl Lavaderos	ø 11/h 4 ø 4 ^{5/16} /h 1 ^{9/16}	1	159597	20,50	Cuillère à spaghetti Spaghetti serving spoon Cuchara para espaguetis	29 11 ^{7/16}	4		168845	17,05
Pince à escargot Snail tong Pinzas caracoles	16 6 ^{5/16}	1	004013	3,45	Fourchette à viande Meat fork Tenedor de carne	29 11 ^{7/16}	4		168844	17,05
Plat à escargot 6 places Snail tray 6 spaces Bandeja caracoles 6 compartimentos	ø 16,6 ø 6 ^{9/16}	6	164138	7,15						

Métal argenté
silver plated - plateado

	cm - inch	MVM	CS	€
Cloche assiette Dome cover Campana	ø 14,8 ø 5 ^{13/16}	1	48	184476 177,00
Cloche assiette Dome cover Campana	ø 22 ø 8 ^{7/8}	1		101510 295,00
Cloche assiette Dome cover Campana	ø 24 ø 9 ^{7/16}	1	16	184477 254,60
Cloche assiette Dome cover Campana	ø 26 ø 10 ^{1/4}	1		101512 304,50
Corbeille à pain ronde en fil Round break basket Panera redonda	ø 17,5/h 6 ø 6 ^{7/8} /h 2 ^{3/8}	1		131114 179,00
Corbeille à pain ronde en fil Round break basket Panera redonda	ø 20,5/h 7,5 ø 8 ^{1/16} /h 2 ^{15/16}	1	5	131115 179,00
Corbeille à pain ovale en fil Oval break basket Panera ovalada	ø 20 x 15/h 6 ø 7 ^{7/8} x5 ^{7/8} /h 2 ^{3/8}	1		131118 179,50

Accessoires
 accessories - accesorios

	cm - inch	MVM	CS	€
Corbeille à pain ovale en fil Oval break basket Panera ovalada	ø 24 x 17/h 7,5 ø 9 ^{7/16} x6 ^{11/16} /h2 ^{15/16}	1		131117 204,00
Bol rince doigts Finger bowl Lavaderos	ø 11/h 4 ø 4 ^{5/16} /h 1 ^{9/16}	1		101453 59,00
Pince à pain Bread tong Pinzas pan	23 9 ^{1/16}	1		101492 51,35
Pince à homard Lobster craker Tenacillas para bogavante	18,5 7 ^{5/16}	1		101493 103,00
Pince à servir Serving tong Pinzas para servir	29,5 11 ^{5/8}	1	10	184355 53,15
Ciseaux à gâteaux Pastry scissors/tong Pinzas para pasteles	20 7 ^{7/8}	1		101494 80,50
Pince à sucre Sugar tong Pinzas para azúcar	11,5 4 ^{1/2}	1		129797 14,85

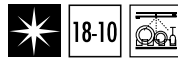

Newport

Bar

Miroir - mirror - brillo

	cm - inch	MVM	CS	€	
Seau à champagne 1 bouteille Champagne bucket 1 bottle Champanera 1 botella	ø 20/h 22,5 ø 7 ^{7/8} /h 8 ^{7/8}	1		186030	89,00
Seau à champagne 2 bouteilles Champagne bucket 2 bottles Champanera 2 botellas	ø 24/h 25,5 ø 9 ^{7/8} /h 10 ^{1/8}	1	6	184180	129,00
Seau à glace avec couvercle Ice bucket with lid Cubitera con tapa	ø 15/h 16 ø 5 ^{7/8} /h 6 ^{5/8}	1	8	184181	97,00
Porte seau à champagne 1 ou 2 bouteilles Champagne bucket stand (1 or 2 bottles) Portacubo 1/2 botellas	h 63,5 25	1	3	185607	145,00
Seau à champagne 1 bouteille Champagne bucket 1 bottle Champanera 1 botella	ø 20/h 22,5 ø 7 ^{7/8} /h 8 ^{7/8}	1	8	188894	287,10

Métal argenté
silver plated - plateado

	cm - inch	MVM	CS	€	
Seau à champagne 2 bouteilles Champagne bucket 2 bottles Champanera 2 botellas	ø 24/h 25,5 ø 9 ^{7/8} /h 10 ^{1/8}	1	6	188895	359,25
Seau à glace avec couvercle Ice bucket with lid Cubitera con tapa	ø 15/h 16 ø 5 ^{7/8} /h 6 ^{5/8}	1		188896	290,00
Porte seau à champagne 1 ou 2 bouteilles Champagne bucket stand (1 or 2 bottles) Portacubo 1/2 botellas	h 63,5 25	1	3	188893	359,25
Rafraichisseur droit double paroi <small>NEW</small> Curved double wall wine cooler stainless steel Enfriador de botella doble pared	ø 13,9/h 19,8 ø 5 ^{1/2} /h 7 ^{3/16}	1		237501	54,00



Newport

Accessoires - accessories - accesorios

	cm - inch	MVM	CS	€	
Verrine à sel aimantée Salt cellar w/magnet Salero con imán	4,1 x 6,7 1 ^{5/8} x 2 ^{5/8}	1	12	216919	9,75
Verrine à poivre aimantée Pepper cellar w/magnet Pimentero con imán	4,1 x 6,7 1 ^{5/8} x 2 ^{5/8}	1	12	216920	9,75

	cm - inch	MVM	CS	€	
Ensemble sel & poivre aimanté Salt & pepper cellar w/magnet Conjunto salero/pimentero con imán	8,5 x 10,6 3 ^{3/8} x 4 ^{3/16}	1		216922	32,50



Newport

Caféteria - coffeeware - cafeteria

Miroir - mirror - brillo	cm - inch	cl - oz	MVM	CS	€	
Pichet Jug Jarra	18,1 x H 23 7 ^{1/8} x 9 ^{1/16}	200 67 ^{5/8}	1	12	213849	116,40
Verseuse Coffee/tea pot Cafetera/tetera	18,1 x H 22,4 7 ^{1/8} x 8 ^{13/16}	150 50 ^{3/4}	1	10	213850	115,80
Verseuse Coffee/tea pot Cafetera/tetera	14,8 x H 14,6 5 ^{13/16} x 5 ^{3/4}	70 23 ^{11/16}	1	16	213851	85,95
Verseuse Coffee/tea pot Cafetera/tetera	12,9 x H 9,3 5 ^{1/16} x 3 ^{11/16}	35 11 ^{13/16}	1	20	213852	72,45

	cm - inch	cl - oz	MVM	CS	€	
Crémier Cream jug Lechera	12,9 x H 9 5 ^{1/16} x 3 ^{9/16}	35 11 ^{13/16}	1	20	213853	49,10
Crémier Cream jug Lechera	9 x H 9 3 ^{9/16} x 3 ^{9/16}	15 5 ^{1/16}	1	40	213854	41,35
Sucrier Sugar bowl Azucarero con tapa		35 11 ^{13/16}	1	20	182341	47,25

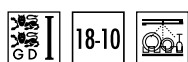

Métal argenté - silver plated - plateado

	cm - inch	cl - oz	MVM	CS	€	
Pichet Jug Jarra	18,1 x H 23 7 ^{1/8} x 9 ^{1/16}	200 67 ^{5/8}	1	12	219561	227,20
Verseuse Coffee/tea pot Cafetera/tetera	18,1 x H 23 7 ^{1/8} x 8 ^{13/16}	150 50 ^{3/4}	1	10	219563	270,15
Verseuse Coffee/tea pot Cafetera/tetera	14,8 x H 14,6 5 ^{13/16} x 5 ^{3/4}	70 23 ^{11/16}	1	16	219564	198,65
Verseuse Coffee/tea pot Cafetera/tetera	12,9 x H 9,3 5 ^{1/16} x 3 ^{11/16}	35 11 ^{13/16}	1	20	219565	170,05

	cm - inch	cl - oz	MVM	CS	€	
Crémier Cream jug Lechera	12,9 x H 9 5 ^{1/16} x 3 ^{9/16}	35 11 ^{13/16}	1	20	219566	112,90
Crémier Cream jug Lechera	9 x H 9 3 ^{9/16} x 3 ^{9/16}	15 5 ^{1/16}	1	40	219567	98,60
Sucrier Sugar bowl Azucarero con tapa		35 11 ^{13/16}	1	20	184612	112,90



Newport

Pots isothermes - insulated pots - jarra isotérmica

Miroir - mirror - brillo	cm - inch	cl - oz	MVM	CS	€	
Pot isotherme Insulated pot Jarra isotérmica	18,1 x H 22,7 7 ^{1/8} x 8 ^{15/16}	120 40 ^{9/16}	1	8	213846	141,45
Pot isotherme Insulated pot Jarra isotérmica	15,6 x H 19,2 6 ^{1/8} x 7 ^{9/16}	70 23 ^{1/3}	1	12	213847	114,45

	cm - inch	cl - oz	MVM	CS	€	
Pot isotherme Insulated pot Jarra isotérmica	13,4 x H 12,7 5 ^{1/4} x 5	30 40	1	18	213848	97,35



Métal argenté - silver plated - plateado

	cm - inch	cl - oz	MVM	CS	€	
Pot isotherme Insulated pot Jarra isotérmica	18,1 x H 22,7 7 ^{1/8} x 8 ^{15/16}	120 40 ^{9/16}	1	8	219557	307,25
Pot isotherme Insulated pot Jarra isotérmica	15,6 x H 19,2 6 ^{1/8} x 7 ^{9/16}	70 23 ^{1/3}	1	12	219558	226,40

	cm - inch	cl - oz	MVM	CS	€	
Pot isotherme Insulated pot Jarra isotérmica	13,4 x H 12,7 5 ^{1/4} x 5	30 40	1	18	219559	194,50

Newport

Plateaux de service - serving trays - bandejas



Miroir - mirror - brillo

	cm - inch	MVM	CS	€
Plateau avec anses Serving tray with handles Bandeja rectangular con asas	60 x 40 23 ^{5/8} x 15 ^{3/4}	1	185022 238955 ¹	170,65
Plateau avec anses (Gastronorm 2/1) Serving tray with handles Bandeja rectangular con asas	65 x 53 25 ^{9/16} x 20 ^{7/8}	1	185023 238954 ¹	208,70
Plateau avec anses Serving tray with handles Bandeja rectangular con asas	77 x 55 30 ^{5/16} x 21 ^{5/8}	1	185018 238953 ¹	293,40
Plateau sans anse Serving tray without handles Bandeja rectangular sin asa	22 x 14 8 ^{11/16} x 5 ^{1/2}	1	227767	28,00

	cm - inch	MVM	CS	€
Plateau sans anse (Gastronorm 1/2) Serving tray without handles Bandeja rectangular sin asa	32,5 x 26,5 12 ^{13/16} x 10 ^{7/16}	1	185019 238960 ²	50,35
Plateau sans anse Serving tray without handles Bandeja rectangular sin asa	40 x 27 15 ^{3/4} x 10 ^{5/8}	1	185020 238961 ²	60,15
Plateau sans anse (Gastronorm 1/1) Serving tray without handles Bandeja rectangular sin asa	53 x 32,5 20 ^{7/8} x 12 ^{13/16}	1	185021 238962 ²	88,40
Plateau rond Round tray Bandeja redonda	ø 42 ø 16 ^{9/16}	1	8 185024	49,10

Métal argenté

silver plated - plateado

	cm - inch	MVM	CS	€
Plateau avec anses Serving tray with handles Bandeja rectangular con asas	60 x 40 23 ^{5/8} x 15 ^{3/4}	1	186460 238965 ¹	485,50
Plateau avec anses (Gastronorm 2/1) Serving tray with handles Bandeja rectangular con asas	65 x 53 25 ^{9/16} x 20 ^{7/8}	1	186459 238964 ¹	573,90
Plateau avec anses Serving tray with handles Bandeja rectangular con asas	77 x 55 30 ^{5/16} x 21 ^{5/8}	1	186458 238963 ¹	662,50
Plateau sans anse Serving tray without handles Bandeja rectangular sin asa	22 x 14 8 ^{11/16} x 5 ^{1/2}	1	227768	116,40

	cm - inch	MVM	CS	€
Plateau sans anse (Gastronorm 1/2) Serving tray without handles Bandeja rectangular sin asa	32,5 x 26,5 12 ^{13/16} x 10 ^{7/16}	1	186463 238970 ²	189,70
Plateau sans anse Serving tray without handles Bandeja rectangular sin asa	40 x 27 15 ^{3/4} x 10 ^{5/8}	1	10 186462 238971 ²	204,35
Plateau sans anse (Gastronorm 1/1) Serving tray without handles Bandeja rectangular sin asa	53 x 32,5 20 ^{7/8} x 12 ^{13/16}	1	186461 238972 ²	292,55
Plateau rond Round tray Bandeja redonda	ø 42 ø 16 ^{9/16}	1	8 186457	233,75

¹ Nouveaux codes à partir du 01/07/2020

¹ New codes valid from 2020/07/01

¹ Nuevos codigos a partir de 01/07/2020

² Nouveaux codes à partir du 01/04/2020

² New codes valid from 2020/04/01

² Nuevos codigos a partir de 01/04/2020



Newport

Table - tableware - mesa

Miroir - mirror - brillo

	cl - oz	cm - inch	MVM	CS	€
Plat rond creux Round deep dish Bandeja redonda		ø 33,5 ø 13 ^{3/16}	1	220120	49,75
Plat ovale Oval dish Fuente ovalada		38 x 25 14 ^{15/16} x 9 ^{13/16}	1	183017 238956 ²	51,60
Plat ovale Oval dish Fuente ovalada		41 x 28 16 ^{1/8} x 11	1	183018 238957 ²	60,15
Plat ovale Oval dish Fuente ovalada		46 x 31 18 ^{1/8} x 12 ^{3/16}	1	183019 238958 ²	84,50
Plat à poisson Fish dish Fuente para pescado		60 x 27 23 ^{5/8} x 10 ^{5/8}	1	183021 238959 ²	87,95

	cl - oz	cm - inch	MVM	CS	€
Saucière Sauce boat Salsera	20 6 ^{3/4}	19 x 7,6 7 ^{1/2} x 3	1	186198	31,90
Porte sucre/Centre de table Sugar holder/Table centerpiece Centro de mesa		ø 5 x 6 ø 1 ^{15/16} x 2 ^{3/8}	6	208862	14,50
Porte sucre/Centre de table Sugar holder/Table centerpiece Centro de mesa		ø 6,4 x 6 ø 2 ^{1/2} x 2 ^{3/8}	6	211397	22,90
Beurrier Butter dish Mantequillera indiv.		ø 7,6 x 7 ø 3 x 2 ^{3/4}	1	185307	23,35
Socle beurrier porcelaine Butter dish base porcelain Mantequillera sin tapa		ø 5 x 3,2 ø 1 ^{5/16} x 1 ^{1/4}	1	190255	6,15

Métal argenté

silver plated - plateado

	cl - oz	cm - inch	MVM	CS	€
Plat rond creux Round deep dish Bandeja redonda		ø 33,5 ø 13 ^{3/16}	1	220121	171,90
Plat ovale Oval dish Fuente ovalada		38 x 25 14 ^{15/16} x 9 ^{13/16}	1	186449 238966 ²	187,90
Plat ovale Oval dish Fuente ovalada		41 x 28 16 ^{1/8} x 11	1	186450 238967 ²	202,45
Plat ovale Oval dish Fuente ovalada		46 x 31 18 ^{1/8} x 12 ^{3/16}	1	186451 238968 ²	217,00

	cl - oz	cm - inch	MVM	CS	€
Plat à poisson Fish dish Fuente para pescado		60 x 27 23 ^{5/8} x 10 ^{5/8}	1	186453 238969 ²	289,85
Saucière Sauce boat Salsera	20 6 ^{3/4}	19 x 7,6 7 ^{1/2} x 3	1	186456	109,80
Beurrier Butter dish Mantequillera indiv.		ø 7,6 x 7 ø 3 x 2 ^{3/4}	1	186455	66,95

² Nouveaux codes à partir du 01/04/2020

² New codes valid from 2020/04/01

² Nuevos codigos a partir de 01/04/2020



Newport cubique

Plateaux de service - serving trays - bandejas

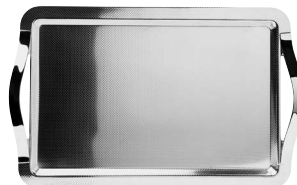

Miroir - mirror - brillo

	cm - inch	MVM	CS	€
Plateau avec anses Serving tray with handles Bandeja rectangular con asas	60 x 40 23 ^{5/8} x 15 ^{3/4}	1	211887 238988 ²	188,95
Plateau avec anses (Gastronorm 2/1) Serving tray with handles Bandeja rectangular con asas	65 x 53 25 ^{9/16} x 20 ^{7/8}	1	211886 238987 ²	230,85
Plateau sans anses Serving tray without handles Bandeja rectangular sin asa	22 x 14 8 ^{1/16} x 5 ^{1/2}	1	211889	30,30

	cm - inch	MVM	CS	€
Plateau sans anses (Gastronorm 1/2) Serving tray without handles Bandeja rectangular sin asa	32,5 x 26,5 12 ^{13/16} x 10 ^{7/16}	1	211888	55,65
Dessous de bouteille Bottle coaster Posabotella	ø 13,5 ø 5 ^{5/16}	1	230872	15,00

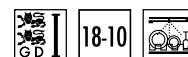

Métal argenté

silver plated - plateado

	cm - inch	MVM	CS	€
Plateau avec anses Serving tray with handles Bandeja rectangular con asas	60 x 40 23 ^{5/8} x 15 ^{3/4}	1	213858 238990 ²	536,85
Plateau avec anses (Gastronorm 2/1) Serving tray with handles Bandeja rectangular con asas	65 x 53 25 ^{9/16} x 20 ^{7/8}	1	213857 238989 ²	638,60
Plateau sans anses Serving tray without handles Bandeja rectangular sin asa	22 x 14 8 ^{1/16} x 5 ^{1/2}	1	213860	128,10

	cm - inch	MVM	CS	€
Plateau sans anses (Gastronorm 1/2) Serving tray without handles Bandeja rectangular sin asa	32,5 x 26,5 12 ^{13/16} x 10 ^{7/16}	1	213859	210,50
Dessous de bouteille Bottle coaster Posabotella	ø 13,5 ø 5 ^{5/16}	1	230874	44,50



Newport Lounge

	cm - inch	MVM	CS	€
Dessous de bouteille Bottle coaster Posabotella	9,5 3 ^{3/4}	1	234320	15,00



Normandy

Plateaux de service - serving trays - bandejas



	cm - inch	MVM	CS	€
Plateau rectangulaire Rectangular tray Bandeja rectangular	26 x 18 10 ^{1/4} x 7 ^{1/16}	1	232972	40,00



² Nouveaux codes à partir du 01/04/2020

² New codes valid from 2020/04/01

² Nuevos codigos a partir de 01/04/2020



DEGRENNE

PARIS



**BUFFET EVENTO
EVENTO BUFFET
BUFÉ EVENTO**

Evento

Chafing Dish

	cm - inch	MWM	CS	€
Chafing acier inoxydable, finition miroir (sans bac) Chafing dish stainless steel, mirror finish (without insert) Chafing dish acabado brillo (sin bandeja)	Ø 35,5 x p 41 x h 15 Ø 14 x d 16 ^{1/8} x h 5 ^{7/8}	1	236195	368,00
Chafing acier inoxydable, finition brossée (sans bac) Chafing dish stainless steel, brushed finish (without insert) Chafing dish acabado satinado (sin bandeja)	Ø 35,5 x p 41 x h 15 Ø 14 x d 16 ^{1/8} x h 5 ^{7/8}	1	236194	368,00
Support chafing, acier inoxydable, finition miroir pour résistance électrique ou porte-brûleur avec gel combustible Chafing stand stainless steel, mirror finish, for electrical and/or sterno heating purposes Soporte para chafing dish acabado brillo - acero inoxidable para resistencia eléctrica o calentador externo	Ø 35 x p 40 x h 12,5 Ø 13 ^{3/4} x d 15 ^{3/4} x h 4 ^{15/16}	1	203005	233,00
Support chafing, acier inoxydable, finition brossée pour résistance électrique ou porte-brûleur avec gel combustible Chafing stand stainless steel, brushed finish, for electrical and/or sterno heating purposes Soporte para chafing dish acabado satinado - acero inoxidable para resistencia eléctrica o calentador externo	Ø 35 x p 40 x h 12,5 Ø 13 ^{3/4} x d 15 ^{3/4} x h 4 ^{15/16}	1	202859	233,00
Résistance 220/240 V avec régulateur de température, 200W Heating element, heat adjustable Resistencia con regulador de temperatura	20 x 20 7 ^{7/8} x 7 ^{7/8}	1	202860	247,70
Résistance 110/120 V US avec régulateur de température, 200W Heating element, heat adjustable Resistencia con regulador de temperatura	20 x 20 7 ^{7/8} x 7 ^{7/8}	1	203468	248,00
Porte-brûleur acier pour gel combustible Burner holder steel Quemador acero inoxidable	Ø 9 x h 6 Ø 3 ^{9/16} x h 2 ^{3/8}	1	202861	39,00
Couvercle avec gouttière acier, verre trempé Lid with stainless steel gutter, tempered glass Tapa en acero inox y vidrio tempaldo	Ø 33 Ø 13	1	203470	319,00
Kit échantillon vérins pour chafing dish Replacing kit for chafing dish cylinder Kit para cambiar el cilindro de un chafing dish		1	217435	50,50
Joint pour chafing dish Seal for chafing dish Junta para chafing dish		1	227406	7,35
Bac en porcelaine pour chafing dish 3 litres Chafing porcelain insert 100oz Bandeja de porcelana para chafing dish	Ø 35,6 x h 7 Ø 14 x h 2 ^{3/4}	1	215721	60,75
1/2 bac porcelaine pour chafing dish avec séparateur 1/2 porcelain insert for chafing dish 1/2 Bandeja de porcelana con delimitador para chafing dish	L 29,3 x l 15 x h 4,6 L 11 ^{9/16} x w 5 ^{7/8} x h 1 ^{13/16}	1	236684	47,87
Bac en acier pour chafing dish 3 litres Chafing stainless steel insert 100oz Bandeja de acero inoxidable para chafing dish	Ø 35,6 x h 7 Ø 14 x h 2 ^{3/4}	1	216142	60,75
1/2 bac porcelaine pour chafing 1 litre 1/2 chafing porcelain insert - 33 ^{13/16} oz 1/2 bandeja de porcelana para chafing	L 29 x l 15 x h 4,5 L 11 ^{7/16} x w 5 ^{7/8} x h 1 ^{3/4}	1	202635	32,20



236195 - 236194



203005 - 202859



203470



215721



216142



236684

NEW



202635



202860 - 203468



202861

Module froid - Refrigerated unit - Modulo refrigerado

		cm - inch	MWM	CS	€	
	Module acier finition miroir + bac plastique GN 1/1 Mirror stainless steel refrigerated set + plastic tray GN 1/1 Modulo de acero acabado brillo + bandeja GN 1/1	L 56,5 x l 36 x h 9,5 22 ^{1/4} x 14 ^{3/16} x 3 ^{3/4}	1	202864	227,00	
	Module acier finition brossée + bac plastique GN 1/1 Brushed stainless steel refrigerated set + plastic tray GN 1/1 Modulo de acero acabado satinado + bandeja GN 1/1	L 56,5 x l 36 x h 9,5 22 ^{1/4} x 14 ^{3/16} x 3 ^{3/4}	1	202865	227,00	
	Module acier noir métallisé + bac plastique GN 1/1 Metallic black refrigerated set + plastic tray GN 1/1 Modulo de acero acabado negro + bandeja GN 1/1	L 56,5 x l 36 x h 9,5 22 ^{1/4} x 14 ^{3/16} x 3 ^{3/4}	1	202869	276,00	
	Module acier finition miroir + bac plastique GN 1/2 Mirror stainless steel refrigerated set + plastic tray GN 1/2 Modulo de acero acabado brillo + bandeja GN 1/2	L 35,6 x l 29,5 x h 9,5 14 x 11 ^{5/8} x 3 ^{3/4}	1	235356	164,00	
	Module acier finition brossée + bac plastique GN 1/2 Brushed stainless steel refrigerated set + plastic tray GN 1/2 Modulo de acero acabado satinado + bandeja GN 1/2	L 35,6 x l 29,5 x h 9,5 14 x 11 ^{5/8} x 3 ^{3/4}	1	235361	164,00	
	Module acier noir métallisé + bac plastique GN 1/2 Metallic black refrigerated set + plastic tray GN 1/2 Modulo de acero acabado negro + bandeja GN 1/2	L 35,6 x l 29,5 x h 9,5 14 x 11 ^{5/8} x 3 ^{3/4}	1	235362	164,00	
	Couvercle module réfrigéré/poignée acier inoxydable Lid for refrigerated set/stainless steel handle Cubierta para el modulo refrigerado/asa acero inoxidable	L 56 x l 35 x h 19 22 ^{1/16} x 13 ^{3/4} x 7 ^{1/2}	1	2	202871	74,10
	Plaque réfrigérante, eutectique GN 1/1 Cooling block, eutectique GN 1/1 Acumulador de refrigeracion GN 1/1	L 48 x l 28 x h 3 18 ^{7/8} x 11 x 1 ^{3/16}	1	208357	22,60	
	Plaque réfrigérante, eutectique GN 1/2 Cooling block, eutectique GN 1/2 Acumulador de refrigeracion GN 1/2	L 18 x l 25 x h 3 7 ^{18/16} x 9 ^{13/16} x 1 ^{3/16}	1	234568	15,30	
	Bac plastique GN 1/1 Plastic tray GN 1/1 Bandeja GN 1/1	L 56 x l 35,5 x h 8 22 ^{1/16} x 14 x 3 ^{1/8}	1	202866	60,60	
	Bac plastique GN 1/2 Plastic tray GN 1/2 Bandeja GN 1/2	L 29,5 x l 35,6 x h 8 11 ^{5/8} x 14 x 3 ^{1/8}	1	235357	82,42	
	Plateau porcelaine GN 2/3 White enamelled porcelain trays GN 2/3 Bandeja porcelana GN 2/3	L 35,4 x l 32,5 13 ^{15/16} x 12 ^{13/16}	1	202628	37,30	
	Plateau porcelaine GN 1/2 White enamelled porcelain trays GN 1/2 Bandeja porcelana GN 1/2	L 26,4 x l 32,5 10 ^{3/8} x 12 ^{13/16}	1	202629	30,55	
	Plateau porcelaine GN 1/3 White enamelled porcelain trays GN 1/3 Bandeja porcelana GN 1/3	L 17,5 x l 32,5 6 ^{7/8} x 12 ^{13/16}	1	202627	24,10	
	Plat creux porcelaine GN 1/3 White enamelled porcelain deep dish GN 1/3 Bandeja honda GN 1/3	L 17,5 x l 32,5 6 ^{7/8} x 12 ^{13/16}	1	202630	26,80	
	Plateau grés carbone GN 2/3 Gres stoneware tray GN 2/3 Bandeja gres tono carbono GN 2/3	L 35,4 x l 32,5 13 ^{15/16} x 12 ^{13/16}	1	234550	38,80	
	Plateau grés carbone GN 1/3 Gres stoneware tray GN 1/3 Bandeja gres tono carbono GN 1/3	L 17,5 x l 32,5 6 ^{7/8} x 12 ^{13/16}	1	234555	25,55	
	Plat à rebords grés carbone GN 1/3 Gres stoneware edge tray GN 1/3 Bandeja con bordes gres tono carbono GN 1/3	L 17,5 x l 32,5 6 ^{7/8} x 12 ^{13/16}	1	234556	29,55	

Evento

Module froid - Refrigerated unit - Modulo refrigerado



	cm - inch	oz - d	M	MM	CS	€	
Newport plateau acier 18-10 GN 1/1, finition miroir Newport serving tray without handle GN 1/1, mirror finish Bandeja rectangular sin asa Newport GN 1/1, acabado brillo	L 53,5 x l 32,5 20 ^{7/8} x 12 ^{13/16}	1				185021 238962*	88,40



Newport plateau acier 18-10 - GN 1/2, finition miroir Newport serving tray without handle GN 1/2, mirror finish Bandeja rectangular sin asa Newport GN 1/2, acabado brillo	L 26,4 x l 32,5 10 ^{3/8} x 12 ^{13/16}	1				185019 238960*	50,35
---	--	---	--	--	--	-------------------	--------------



Plateau verre gris GN 1/1 Grey glass tray GN 1/1 Bandeja cristal gris GN 1/1	L 53,5 x l 32,5 - Epaisseur/espesor : 6 mm 20 ^{7/8} x 12 ^{13/16} - Thickness : 1/4	1				230752	47,10
---	---	---	--	--	--	--------	--------------



Plateau verre gris GN 2/3 Grey glass tray GN 2/3 Bandeja cristal gris GN 2/3	L 35,4 x l 32,5 - Epaisseur/espesor : 6 mm 13 ^{15/16} x 12 ^{13/16} - Thickness : 1/4	1				230753	40,20
---	---	---	--	--	--	--------	--------------



Plateau mélamine bois GN 1/1 Wood melamine tray GN 1/1 Bandeja melamina madera GN 1/1	L 53,5 x l 32,5 20 ^{7/8} x 12 ^{13/16}	1				234546	67,40
--	--	---	--	--	--	--------	--------------



Plateau mélamine bois GN 2/3 Wood melamine tray GN 2/3 Bandeja melamina madera GN 2/3	L 35,4 x l 32,5 13 ^{15/16} x 12 ^{13/16}	1				234548	44,90
--	--	---	--	--	--	--------	--------------



Plateau mélamine bois GN 1/2 Wood melamine tray GN 1/2 Bandeja melamina madera GN 1/2	L 26,4 x l 32,5 10 ^{3/8} x 12 ^{13/16}	1				234551	34,80
--	--	---	--	--	--	--------	--------------



Plateau mélamine bois GN 1/3 Wood melamine tray GN 1/3 Bandeja melamina madera GN 1/3	L 17,5 x l 32,5 6 ^{7/8} x 12 ^{13/16}	1				234553	26,55
--	---	---	--	--	--	--------	--------------

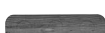

Plateau 3 trous mélamine bois GN 1/6 Wood melamine tray 3 holes GN 1/6 Bandeja melamina madera con 3 huellas GN 1/6	L 8,7 x l 32,5 3 ^{7/16} x 12 ^{13/16}	1				234557	15,30
--	---	---	--	--	--	--------	--------------



Plateau mélamine pierre GN 1/1 Stone melamine tray GN 1/1 Bandeja melamina piedra GN 1/1	L 53,5 x l 32,5 20 ^{7/8} x 12 ^{13/16}	1				234547	67,40
---	--	---	--	--	--	--------	--------------



Plateau mélamine pierre GN 2/3 Stone melamine tray GN 2/3 Bandeja melamina piedra GN 2/3	L 35,4 x l 32,5 13 ^{15/16} x 12 ^{13/16}	1				234549	44,90
---	--	---	--	--	--	--------	--------------



Plateau mélamine pierre GN 1/2 Wood melamine tray GN 1/2 Bandeja melamina madera GN 1/2	L 26,4 x l 32,5 10 ^{3/8} x 12 ^{13/16}	1				234552	34,80
--	--	---	--	--	--	--------	--------------



Plateau mélamine pierre GN 1/3 Wood melamine tray GN 1/3 Bandeja melamina madera GN 1/3	L 17,5 x l 32,5 6 ^{7/8} x 12 ^{13/16}	1				234554	26,55
--	---	---	--	--	--	--------	--------------



Plateau 3 trous mélamine pierre GN 1/6 Wood melamine tray 3 holes GN 1/6 Bandeja melamina madera con 3 huellas GN 1/6	L 8,7 x l 32,5 3 ^{7/16} x 12 ^{13/16}	1				234558	15,30
--	---	---	--	--	--	--------	--------------



Plateau acrylique gris - 1 trou - GN 1/2 adapté aux bols 22 cm Grey acrylic tray GN1/2 - 1 hole adapted for bowls 8,6 inch Bandeja acrílico gris GN 1/2 - 1 agujero adaptados a boles de 22 cm	L 26,5 x l 32,5 - Epaisseur /espesor : 10 mm 10 ^{3/8} x 12 ^{13/16} - Thickness : 3/8	1				230755	52,75
---	---	---	--	--	--	--------	--------------



Plateau acrylique gris - 2 trous - GN 1/1 Grey acrylic tray GN1/1 - 2 holes Bandeja acrílico gris GN 1/1 - 2 agujeros	L 53,5 x l 32,5 - Epaisseur /espesor : 10 mm 20 ^{7/8} x 12 ^{13/16} - Thickness : 3/8	1				230756	99,90
--	---	---	--	--	--	--------	--------------



Plateau acrylique - 2 trous - GN 1/3 adapté aux bols 14 cm et carafes Grey acrylic tray GN 1/3 - 2 holes adapted for bowls 5,5 inch and carafes Bandeja acrílico GN 1/3 - 2 agujeros adaptados a boles de 14 cm	L 17,6 x l 32,5 - Epaisseur /espesor : 10 mm 6 ^{7/8} x 12 ^{13/16} - Thickness : 3/8	1				230757	47,15
--	--	---	--	--	--	--------	--------------



Bol Modulo blanc White deep bowl, soup Modulo Bol hondo blanco Modulo	Ø 14 Ø 5 ^{1/2}	6				154245	8,31
--	----------------------------	---	--	--	--	--------	-------------



Bol Evento blanc White Evento bowl Bol blanco Evento	Ø 22 Ø 8 ^{11/16}	6				202625	23,07
---	------------------------------	---	--	--	--	--------	--------------



Bol porcelaine Modulo Deep bowl, large Bol hondo	Ø 28 Ø 11	6				142722	38,05
---	--------------	---	--	--	--	--------	--------------

*Nouveaux codes à partir du 01/04/2020

*New codes valid from 2020/04/01

*Nuevos codigos a partir de 01/04/2020

Urne à jus de fruits - Fruit juice urn - Dispensador de zumos



231303 - 231304

	cm - inch	oz - d	MWM	CS	€
Urne à jus de fruits 4L - socle noir - acier miroir 18-10 Juice dispenser 4L - Black stand - mirror finish 18-10 Dispensador de zumo, acero 18-10 acabado brillo	l 20 x p 32 x h 45 w 7 ^{7/8} x d 12 ^{5/8} x h 17 ^{11/16}	400 135 ^{1/4}	1		231303 343,00
Urne jus de fruits 4L - socle noir - acier brossé 18-10 Juice dispenser - black stand - brushed finish 18-10 Dispensador de zumo, acero 18-10 acabado satinado	l 20 x p 32 x h 45 w 7 ^{7/8} x d 12 ^{5/8} x h 17 ^{11/16}	400 135 ^{1/4}	1		231304 343,00
Couvercle urne miroir, acier 18-10 finition miroir Lid for mirror finish dispenser - stainless 18-10 Tapa para dispensador en brillo	Ø 17,9 Ø 7 ^{1/16}		1		202881 46,35
Couvercle urne brossé, acier 18-10 finition brossée Lid for brushed finish dispenser - stainless 18-10 Tapa para dispensador satinada	Ø 17,9 Ø 7 ^{1/16}		1		202891 46,40
Tube pour glace, acier 18-10 Ice tub, stainless steel 18-10 Tubo para hielo, acero 18-10	Ø 9 Ø 3 ^{9/16}		1		202884 62,95
Robinet - acier + ABS chromé noir Faucet, stainless steel and black ABS Grifo, acero inoxidable + negro ABS			1		214724 57,75
Fût cylindrique urne Container for dispenser Contenedor para el dispensador	Ø 17,7 x h 25,5 Ø 6 ^{15/16} x h 10 ^{1/16}	500 169 ^{1/16}	1		202883 49,75
Base acier miroir urne, acier 18-10 Steel stand mirror finish for dispenser stainless steel 18-10 Soporte acero brillo para dispensador, acero 18-10	Ø 17,6 x h 19 Ø 6 ^{15/16} x h 7 ^{1/2}		1		202890 70,60
Base acier brossé urne, acier 18-10 Steel stand brushed finish for dispenser stainless steel 18-10 Soporte acero satinado para dispensador, acero 18-10	Ø 17,6 x h 19 Ø 6 ^{15/16} x h 7 ^{1/2}		1		202889 70,60
Grille acier pour gouttes, acier 18-10 Steel grid drop collector, stainless 18-10 Rejilla de acero para recoger el goteo, acero 18-10	Ø 9 Ø 3 ^{9/16}		1		045963 4,50
Socle acrylique noir urne à jus de fruits Black acrylic stand for juice dispenser Base del dispensador, acrylic	20 x 32 - Epaisseur/Espesor : 2 cm 7 ^{7/8} x 12 ^{5/8} - Thickness : . 13/16		1		230758 84,50
Carafe à jus de fruits verre, cristallin soufflé bouche Juice/Beverage carafe, Hand Blown Crystalline Botella para zumos cristal	Ø 10,5 x h 27,5 Ø 4 ^{1/8} x h 10 ^{13/16}	120 40 ^{9/16}	1	6	202639 18,00
Bouchon de carafe silicone Silicone stopper for carafe Tapón para botella silicona	Ø 6,5 x h 4,2 Ø 2 ^{9/16} x h 1 ^{5/8}		1		202855 7,60

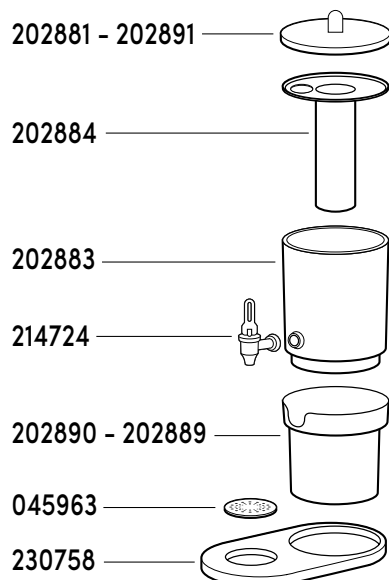

Evento

Distributeur à céréales - Cereal dispenser - Dispensador de cereales



231299



	cm - inch	oz - d	MWM	CS	€
Distributeur à céréales, socle noir x 1 Container for cereal dispenser x 1 Dispensador de cereales x 1	l 19 x p 20 x h 55,5 w 7 ^{1/2} x d 7 ^{7/8} x h 21 ^{7/8}	350 1gal.	1	231299	302,00
Distributeur à céréales, socle noir x 3 Container for cereal dispenser x 3 Dispensador de cereales x 3	l 50 x p 20 x h 55,5 w 19 ^{11/16} x d 7 ^{7/8} x h 21 ^{7/8}	350 1gal.	1	231300	799,00
Couvercle distributeur à céréales, finition miroir acier 18-10 Lid for cereal dispenser, mirror finish, stainless steel 18-10 Tapa para dispensador en brillo, acero 18-10	Ø 12,5 Ø 4 ^{15/16}		1	213078	24,25
Fût cylindrique avec ailette et poignée distributeur céréales Barrel + handle + rolling tap for cereal dispenser Contenedor para el dispensador con aleta y asa	p 16,1 x h 42 d 6 ^{5/16} x h 16 ^{3/16}		1	213076	189,00
Base + tube + socle noir + distributeur à céréales x 1 Stainless steel stand + tub + black acrylic stand for cereal dispenser x 1 Base + tubo + zócalo + dispensador de cereales x 1	l 19 x h 27,5 w 7 ^{1/2} x h 29 ^{3/4}		1	231301	117,50
Base + tube + socle noir + distributeur à céréales x 3 Stainless steel stand + tub + black acrylic stand for cereal dispenser x 3 Base + tubo + zócalo + dispensador de cereales x 3	l 50 x h 27,5 w 19 ^{11/16} x h 29 ^{3/4}		1	231302	234,00
Bol empilable Porcelain stackable bowl Bol porcelana apilable	Ø 14 Ø 5 ^{1/2}		6	202626	7,14
Carafe à lait - porcelaine Porcelain juice/beverage carafe Botella para leche porcelana	Ø 10,5 x h 27,5 Ø 4 ^{1/8} x h 10 ^{13/16}	120 40 ^{9/16}	1	202636	18,75
Bouchon de carafe silicone Silicone stopper for carafe Tapón para botella silicona	Ø 6,5 x h 4,2 Ø 2 ^{9/16} x h 1 ^{5/8}		1	202855	7,60

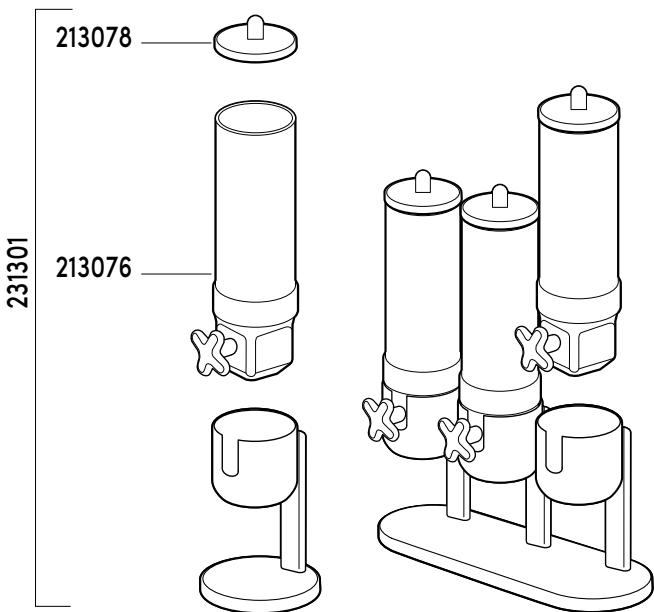

231302



231299



231300





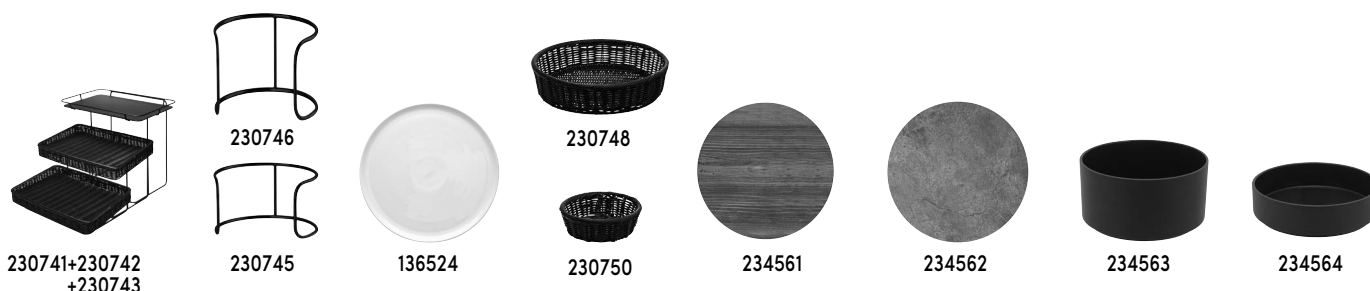















Supports fils & accessoires - Trays & accessories - Bandeja & accesorios

	cm - inch	MWM	CS	€
Support rond noir bas Black round stand, low level Soporte redondo bajo negro	Ø 25 x h 13 Ø 9 ^{13/16} x h 5 ^{1/8}	1	230745	47,75
Support rond noir haut Black round stand, high level Soporte redondo alto negro	Ø 25 x h 26 Ø 9 ^{13/16} x h 10 ^{1/4}	1	230746	54,40
Support rectangulaire noir niveau 1 Black rectangular tray, level 1 Soporte rectangular negro, nivel 1	l 44 x p 30,8 x h 10,8 w 17 ^{5/16} x d 12 ^{1/8} x h 4 ^{1/4}	1	230741	56,15
Support rectangulaire noir niveau 2 Black rectangular tray, level 2 Soporte rectangular negro, nivel 2	l 42 x p 30,8 x h 29,8 w 16 ^{5/16} x d 12 ^{1/8} x h 11 ^{3/4}	1	230742	62,20
Support rectangulaire noir niveau 3 Black rectangular, level 3 Soporte rectangular negro, nivel 3	l 40 x p 30,8 x h 48,8 w 15 ^{3/4} x d 12 ^{1/8} x h 19 ^{3/16}	1	230743	80,95
Support rectangulaire niveau 1+2 Rectangular tray, level 1+2 Soporte rectangular, nivel 1+2	l 44 x p 50 x h 29,8 w 17 ^{5/16} x d 19 ^{11/16} x h 11 ^{3/4}	1	230741 230742	118,35
Support rectangulaire niveau 2+3 Rectangular tray, level 2+3 Soporte rectangular, nivel 2+3	l 42 x p 50 x h 48,8 w 16 ^{9/16} x d 19 ^{11/16} x h 19 ^{3/16}	1	230742 230743	143,15
Support rectangulaire niveau 1+2+3 Rectangular tray, level 1+2+3 Soporte rectangular, nivel 1+2+3	l 44 x p 68,2 x h 48,8 w 17 ^{5/16} x d 26 ^{7/8} x h 19 ^{3/16}	1	230741 230742 230743	199,30
Cadre acier noir Black steel tray for stand Estructura de acero negro	l 55,5 x p 35 x h 4,5 w 21 ^{7/8} x d 13 ^{3/4} x h 1 ^{3/4}	1	230744	74,50
Panière ronde noire Black round bread basket Cesta bollería redonda negro	Ø 32 x h 8 Ø 12 ^{5/8} x h 3 ^{1/8}	1	230748	23,85
Panière rectangulaire noire Black rectangular bread basket Cesta bollería rectangular negro	54 x 34 x h 7 21 ^{1/4} x 13 ^{3/8} x h 2 ^{3/4}	1	230749	47,10
Panière individuelle noire Black individual bread basket Cesta bollería individual negro	Ø 18 x h 6 Ø 7 ^{1/16} x h 2 ^{3/8}	1	230750	12,00
Panière à baguette noire Black baguette basket Cesta para baguette negro	Ø 27 x h 52 Ø 10 ^{5/8} x h 20 ^{1/2}	1	230751	86,50
Plat à tarte porcelaine Modulo Pie/Pizza plate, flat Modulo Fuente para pastel Modulo	Ø 32 Ø 12 ^{5/8}	1	136524	21,13
Plateau verre gris rond Grey round tempered glass Bandeja cristal redonda	Ø 32 Ø 12 ^{5/8}	1	230754	35,70
Plateau mélamine bois rond Wood melamine round tray Bandeja redonda melamina madera	Ø 32 Ø 12 ^{5/8}	1	234561	35,20
Plateau mélamine pierre rond Stone melamine round tray Bandeja redonda piedra madera	Ø 32 Ø 12 ^{5/8}	1	234562	35,20
Saladier bas grès carbone Gres stoneware low salad bowl Ensaladera gres tamano bajo tono carbono	Ø 25,4 x 7 cm - 2,4 l Ø 10 in x 2 in ^{3/4} - 80 oz ^{1/8}	1	234564	27,60
Saladier haut grès carbone Gres stoneware high salad bowl Ensaladera gres tamano alto tono carbono	Ø 25,4 x 13 cm - 5,1 l Ø 10 in x 5 in ^{1/8} - 172 oz ^{7/16}	1	234563	44,40



Evento

Accessoires - Accessories - Accesorios

		cm - inch	cl - oz	MWM	CS	€
	Saladier bleu de roche Blue stone bowl NEW Bol azul de roca	Ø 28 Ø 11	400 135 ^{1/4}	1	235222	56,70
	Saladier dune Beige dune bowl NEW Bol beis duna	Ø 28 Ø 11	400 135 ^{1/4}	1	235223	56,70
	Support couverts de service coloris blanc Serving cutlery display white porcelain Soporte para piezas de servicio porcelana blanca	21 x 10 x 5 8 ^{1/4} x 3 ^{15/16} x 1 ^{15/16}		1	202633	10,00
	Etiquette porcelaine + support acier Porcelain stick + stainless steel stand Etiqueta de porcelana + soporte acero inox	10 x 5 3 ^{15/16} x 1 ^{15/16}		2	202632	10,95
	Bol empilable Porcelain stackable bowl Bol porcelana apilable	Ø 14 Ø 5 ^{1/2}		6	202626	7,14
	Présentoir à gâteaux rond Ø 25 cm Round app/pizza/presentation stand Expositor de tartas	Ø 25 Ø 9 ^{13/16}		6	209381	21,62
	Présentoir à gâteaux rond Ø 32 cm Round app/pizza/presentation stand Expositor de tartas	Ø 32 Ø 12 ^{5/6}		6	209382	36,03
	Planche à pain bambou avec récupérateur de miettes GN 1/1* Bamboo bread board with crumb tray GN 1/1* Panera de bambou con recogedor de migas GN 1/1*	53 x 32,5 20 ^{7/8} x 12 ^{13/16}		1	202854	66,30
	Couteau à pain l'Econome éco nature, positionnable dans la planche à pain Econome eco nature bread knife fits in a slot in the bread board Cuchillo de pan Econome eco nature se encaja en una ranura de la panera	18 7 ^{1/16}		1	217814	18,65
	Couteau l'ECONOME by STARCK® positionnable dans la planche ECONOME by STARCK® bread knife fits in a slot in the bread board Cuchillo de pan ECONOME by STARCK® se encaja en una ranura de la panera	24 9 ^{7/16}		1	229516	42,00
	Plancha avec manche mélamine bois Wood melamine board Plancha con mango melamina madera	17,5 x 45 6 ^{7/8} x 17 ^{11/16}		1	234559	35,70
	Plancha avec manche mélamine pierre Stone melamine board Plancha con mango melamina piedra	17,5 x 45 6 ^{7/8} x 17 ^{11/16}		1	234560	35,70
	Pince à servir Serving tong Pinzas para servir	29,5 11 ^{5/8}		1	204499	26,90
	Pince à pain Bread tong Pinzas pan	23 9 ^{1/16}		1	204498	18,40
	Ciseaux à gâteaux Pastry scissors/tong Pinzas para pasteles	20 7 ^{7/8}		1	204496	50,40
	Cuillère à toast Appetizer spoon Cuchara aperitivo	11,8 4 ^{5/8}		1	130994	2,60
	Cuillère à spaghetti Spaghetti serving spoon Cuchara para espaguetis	29 11 ^{7/16}		4	168845	17,05
	Repose cuillère porcelaine Spoon rest with ceramic bowl Cuchara descansa en porcelana	H 23,5 x L 11,5 cm 9 ^{3/4} x 4 in ^{1/2}		1	130610	10,50
	Louche à sauce Soup ladle Cazo	29,7 11 ^{11/16}		1	153193	28,90
	Louchette Gravy ladle Cucharón	29 11 ^{7/16}		4	168846	17,05



DEGRENNE
PARIS



CUISINE
KITCHENWARE
COCINA

Idéal forgé



	cm inch	MVM	CS	€		cm inch	MVM	CS	€	
Couteau office Paring knife Cuchillo mondador	8 3 ^{1/8}	6		218590	25,95	Couteau filet de sole Fileting knife Cuchillo para filetar	15 6	1	218611	34,60
Couteau office Paring knife Cuchillo mondador	10 4	1		218587	27,05	Couteau à jambon alvéolé Ham Slicer granton edge Cuchillo jamoner alveolado	30 12	1	218583	86,50
Couteau office bec oiseau Curved blade Paring knife Cuchillon mondador pico de pajaró	8 3 ^{1/16}	6		218585	27,05	Couteau à désosser Boning knife Cuchillo deshuesador	13 5	1	218626	34,60
Couteau de cuisine Chef's knife Cuchillo de cocina	15 6	1		218593	36,75	Couteau à désosser Boning knife Cuchillo deshuesador	15 6	1	218628	36,75
Couteau de cuisine Chef's knife Cuchillo de cocina	20 8	1		218596	47,60	Fusil à aiguiser-ABS Sharpening steel-ABS Afilador-ABS	30 12	1	217879	25,95
Couteau de cuisine Chef's knife Cuchillo de cocina	25 10	1		218600	58,40	Fusil à aiguiser Sharpening steel Afilador	25 10	1	217880	25,40
Couteau tranchelard Slicing knife Cuchillo para cortar	15 6	1		218609	34,60	Couteau à découper yatagan Yatagan carving knife Cuchillo de trinchar Yatagan	20 8	1	218623	47,60
Couteau tranchelard Slicing knife Cuchillo para cortar	20 8	1		218613	45,40	Fourchette à viande Meat fork Tenedor de carne	17 6 ^{11/16}	1	217868	36,75
Couteau tranchelard Slicing knife Cuchillo para cortar	25 10	1		218616	56,25	Couteau à steak Steak knife serrated Cuchillo chuletero	13 5	6	218579	31,35
Couteau santoku Santoku knife granton edge Cuchillo santoku	18 7 ^{1/16}	1		218629	56,25	Couteau à pain Bread knife Cuchillo de pan	20 8	1	218619	47,65

Idéal forgé olivier



Non-disponible pour le marché Américain et Russe
Non available for the US and the Russian markets

	cm inch	MVM	CS	€		cm inch	MVM	CS	€	
Couteau office Paring knife Cuchillo mondador	10 4	6		218591	31,35	Couteau santoku Santoku knife granton edge Cuchillo santoku	18 7 ^{1/16}	1	218630	62,75
Couteau de cuisine Chef's knife Cuchillo de cocina	15 6	3		218595	44,35	Fusil à aiguiser Sharpening steel Afilador	20 8	1	217883	29,20
Couteau de cuisine Chef's knife Cuchillo de cocina	20 8	3		218599	54,05	Couteau à découper yatagan Yatagan Carving knife Cuchillo de trinchar Yatagan	20 8	1	218625	54,10
Couteau de cuisine Chef's knife Cuchillo de cocina	25 10	1		218602	62,75	Fourchette à viande Meat fork Tenedor de carne	17 6 ^{11/16}	1	217872	44,35
Couteau tranchelard Slicing knife Cuchillo para cortar	15 6	1		218612	43,25	Couteau à pain Bread knife Cuchillo de pan	20 8	1	218622	54,10



L'Économe®

Eco nature - Natural hue - Tinte natural

	cm inch	MVM	CS	€
Économe Peeler Pelador	10 4	12		217523 4,25
Couteau office pointu Paring knife Cuchillo mondador	9 3 ^{15/16}	12		217687 5,75
Couteau office bec oiseau Curved blade Paring knife Cuchillo mondador pico de pajaró	6,5 2 ^{5/8}	1		226270 5,75
Couteau à découper Slicing knife Cuchillo de trinchar	20 8	1		217804 25,50

	cm inch	MVM	CS	€
Couteau de cuisine Chef's knife Cuchillo de cocina	15 6	1		217806 24,75
Couteau de cuisine Chef's knife Cuchillo de cocina	20 8	1		217808 28,20
Couteau à pain Bread knife Cuchillo de pan	18 7 ^{1/16}	1		217814 18,65



L'Économe®

Bois laqué - Gloss finish wood - Madera lacada

Anis - Anise - Verde

	cm inch	MVM	CS	€
Économe Peeler Pelador	10 4	12		217532 4,35
Flexiconome tomate Tomato flexiconome Cuchillo mondador	9 3 ^{15/16}	12		217538 7,95
Couteau office pointu Paring knife Cuchillo mondador	9 3 ^{15/16}	12		217695 5,75
Couteau office bec oiseau Curved blade Paring knife Cuchillo mondador pico de pajaró	6,5 2 ^{5/8}	12		217799 5,75

Fuchsia - Pink - Rosa

	cm inch	MVM	CS	€
Économe Peeler Pelador	10 4	12		217533 4,35
Flexiconome universel Utility flexiconome Cuchillo mondador	9 3 ^{15/16}	12		217536 7,95
Couteau office pointu Paring knife Cuchillo mondador	9 3 ^{15/16}	12		217696 5,75
Couteau office bec oiseau Curved blade Paring knife Cuchillo mondador pico de pajaró	6,5 2 ^{5/8}	12		217800 5,75

Aubergine - Purple - Violeta

	cm inch	MVM	CS	€
Économe Peeler Pelador	10 4	12		217528 4,35
Flexiconome julienne Julienne flexiconome Cuchillo mondador	9 3 ^{15/16}	12		217540 7,95
Couteau office pointu Paring knife Cuchillo mondador	9 3 ^{15/16}	12		217691 5,75
Couteau office bec oiseau Curved blade Paring knife Cuchillo mondador pico de pajaró	6,5 2 ^{5/8}	12		217795 5,75

Mandarine - Orange - Naranja

	cm inch	MVM	CS	€
Économe Peeler Pelador	10 4	12		217529 4,35
Couteau office pointu Paring knife Cuchillo mondador	9 3 ^{15/16}	12		217692 5,75
Couteau office bec oiseau Curved blade Paring knife Cuchillo mondador pico de pajaró	6,5 2 ^{5/8}	12		217796 5,75



L'Économe by Starck®

Acier - Stainless steel - Acero

	cm inch	MVM	CS	€
Couteau de cuisine - lame Chef's knife - blade Cuchillo de cocina - hoja	14 5 ^{1/2}	1		229515 42,00

	cm inch	MVM	CS	€
Couteau à pain - lame Bread knife - blade Cuchillo de pan - hoja	24 9 ^{7/16}	1		229516 42,00

Pack 4 pièces - Econome - couteau bec oiseau - flexiconome couteau office
Pack 4 pieces set - Peeler Curved blade paring knife - flexiconome Paring knife
Paquete de 4 piezas - Econome - Bec cuchillos - flexiconome Cuchillo mondador

		1		229514 76,20
--	--	---	--	---------------------



Newcook Expert

	cm inch	MVM	CS	€		cm inch	MVM	CS	€	
Casserole Saucepan Cazo	14 5 ^{1/2}	1		223972	74,10	Couvercle acier Stainless steel lid Tapa	14 5 ^{1/2}	1	223987	21,60
Casserole Saucepan Cazo	16 6 ^{5/16}	1		223973	82,45	Couvercle acier Stainless steel lid Tapa	16 6 ^{5/16}	1	223988	23,25
Casserole Saucepan Cazo	18 7 ^{1/16}	1		223974	91,60	Couvercle acier Stainless steel lid Tapa	18 7 ^{1/16}	1	223989	24,90
Casserole Saucepan Cazo	20 7 ^{7/8}	1		223975	99,95	Couvercle acier Stainless steel lid Tapa	20 7 ^{7/8}	1	223990	26,60
Poêle Frying pan Sartén	24 9 ^{7/16}	1		223977	95,80	Couvercle acier Stainless steel lid Tapa	24 9 ^{7/16}	1	223991	29,95
Poêle Frying pan Sartén	28 11	1		223979	112,40	Couvercle acier Stainless steel lid Tapa	28 11	1	223992	33,30
Faitout Stewpot Olla	24 9 ^{7/16}	1		223985	129,10	Ensemble de 3 casseroles Set of 3 saucepan Set de 3 cazos	16/18/20 6 ^{5/16} to 7 ^{7/8}	1	223993	216,65
Cocotte ovale avec couvercle Oval French oven with lid Oola ovalada	24 x 30 11 ^{13/16} x 9 ^{7/16}	1		223986	174,95					



DEGRENE
PARIS



VERRE
GLASSWARE
CRISTALERIA



Allegro



	cl - oz	cm - inch	MVM	CS	€		cl - oz	cm - inch	MVM	CS	€		
Gobelet bleu nuit Blue night tumbler Vaso azul	29 9 ^{13/16}	ø 7,2 x h 9,5 ø 2 ^{13/16} x h 3 ^{3/4}	6	12	199461	7,10	Gobelet rouge Red tumbler Vaso rojo	29 9 ^{13/16}	ø 7,2 x h 9,5 ø 2 ^{13/16} x h 3 ^{3/4}	6	12	225516	7,40
Gobelet bleu nuit Blue night tumbler Vaso azul	40 13 ^{1/2}	ø 8 x h 12,1 ø 3 ^{1/8} x h 4 ^{3/4}	6	12	234490	8,45	Gobelet blanc White tumbler Vaso blanco	29 9 ^{13/16}	ø 7,2 x h 9,5 ø 2 ^{13/16} x h 3 ^{3/4}	6	12	180939	7,40
Gobelet vert pomme Apple green tumbler Vaso verde	29 9 ^{13/16}	ø 7,2 x h 9,5 ø 2 ^{13/16} x h 3 ^{3/4}	6	12	199462	7,10	Gobelet noir Black tumbler Vaso negro	29 9 ^{13/16}	ø 7,2 x h 9,5 ø 2 ^{13/16} x h 3 ^{3/4}	6	12	180936	7,40
Gobelet cassis Purple tumbler Vaso púrpura	29 9 ^{13/16}	ø 7,2 x h 9,5 ø 2 ^{13/16} x h 3 ^{3/4}	6	12	174510	7,10	Gobelet transparent Transparent tumbler Vaso transparente	29 9 ^{13/16}	ø 7,2 x h 9,5 ø 2 ^{13/16} x h 3 ^{3/4}	6	12	206936	5,00
Gobelet gris Grey tumbler Vaso gris	29 9 ^{13/16}	ø 7,2 x h 9,5 ø 2 ^{13/16} x h 3 ^{3/4}	6	12	225517	7,10	Gobelet transparent Transparent tumbler Vaso transparente	40 13 ^{1/2}	ø 8 x h 12,1 ø 3 ^{1/8} x h 4 ^{3/4}	6	12	234489	6,40
Gobelet gris Grey tumbler Vaso gris	40 13 ^{1/2}	ø 8 x h 12,1 ø 3 ^{1/8} x h 4 ^{3/4}	6	12	234491	8,45							

Anytime



	cl - oz	cm - inch	MVM	CS	€		cl - oz	cm - inch	MVM	CS	€		
Verre à cognac Cognac glass Vaso coñac	61 20 ^{5/8}	ø 10,4 x h 15,5 ø 4 ^{1/8} x h 6 ^{1/8}	6		184570	6,10	Verre à bière Beer glass Vaso cerveza	39 13 ^{3/16}	ø 7,3 x h 17,7 ø 2 ^{1/8} x h 6 ^{15/16}	6		184569	5,55
Verre à porto/cherry Cherry glass Copa Jerez/Oporto	10,4 3 ^{1/2}	ø 5,6 x h 16,9 ø 2 ^{3/8} x h 6 ^{5/8}	6		190700	4,40	Flûte à champagne Champagne flute Flauta champagne	15 5 ^{1/16}	ø 6,3 x h 19,3 ø 2 ^{1/2} x h 7 ^{5/8}	6		184567	4,60
Verre à Martini Martini glass Copa	25 8 ^{7/16}	ø 10,6 x h 16,8 ø 4 ^{3/16} x h 6 ^{5/8}	6		195628	6,10	Verre à champagne Champagne glass Flauta champagne	21 7 ^{1/8}	ø 6,8 x h 20,5 ø 2 ^{1/16} x h 8 ^{1/16}	6		184597	5,50
Verre à margarita Margarita glass Copa Margarita	34 11 ^{1/2}	ø 11,1 x h 17,2 ø 4 ^{3/8} x h 6 ^{3/4}	6		209814	7,15	Coupe à champagne Champagne glass Copa champagne	23 7 ^{3/4}	ø 9,5 x h 14,7 ø 3 ^{3/4} x h 5 ^{13/16}	6		210281	5,75
Verre à shooter Shot glass Copa shooter	4,5 1 ^{1/2}	ø 4,6 x h 8 ø 1 ^{13/16} x h 3 ^{1/8}	6		209813	3,85	Coupelle Brazil Appetizer Vaso	30 10 ^{1/8}	ø 13,2 x h 8,7 ø 5 ^{3/16} x h 3 ^{7/16}	6	12	109439	7,15
Verre à cocktail Cocktail glass Copa cocktail	48 16 ^{1/4}	ø 8 x h 20,9 ø 3 ^{1/8} x h 8 ^{1/4}	6		209815	6,10	Verrine Rondo Appetizer glass Vasitos	13 4 ^{3/8}	ø 5,5 x h 6 ø 2 ^{3/16} x h 2 ^{3/8}	6		181874	2,90

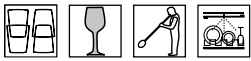

Bilbao



	cl - oz	cm - inch	MVM	CS	€
Gobelet bleu roche Blue tumbler Vaso azul	30 10 ^{1/8}	ø 8,8 x h 8,8 ø 3 ^{7/16} x h 3 ^{7/16}	6		230889 6,90
Gobelet sable rose Pink tumbler Vaso rosa	30 10 ^{1/8}	ø 8,8 x h 8,8 ø 3 ^{7/16} x h 3 ^{7/16}	6		230890 6,90
Gobelet basalte Grey tumbler Vaso gris	30 10 ^{1/8}	ø 8,8 x h 8,8 ø 3 ^{7/16} x h 3 ^{7/16}	6		230891 6,90

	cl - oz	cm - inch	MVM	CS	€
Gobelet vert argile Green tumbler Vaso verde	30 10 ^{1/8}	ø 8,8 x h 8,8 ø 3 ^{7/16} x h 3 ^{7/16}	6		235133 6,90
Gobelet incolore Transparent tumbler Vaso transparente	30 10 ^{1/8}	ø 8,8 x h 8,8 ø 3 ^{7/16} x h 3 ^{7/16}	6		236988 6,00



Carafes/Décanteurs

Carafes/Decanters

	cl - oz	cm - inch	MVM	CS	€
Décanteur Millésime Decanter Decantador	135 45 ^{5/8}	ø 20,5 x h 23,5 ø 8 ^{1/16} x h 9 ^{1/4}	1		169728 50,50
Décanteur Vindemia Decanter Decantador	135 45 ^{5/8}	ø 23 x h 24 ø 9 ^{1/16} x h 9 ^{7/16}	1	4	188969 36,20
Décanteur Nectar Decanter Decantador	100 33 ^{13/16}	ø 13,5 x h 24,5 ø 5 ^{5/16} x h 9 ^{5/8}	1		210904 28,50
Carafe à Whisky Anytime Whisky carafe Jarra de whisky	120 40 ^{9/16}	ø 9,5 x h 26 ø 3 ^{3/4} x h 10 ^{1/4}	1		199027 38,90
Carafe Héritage Pitcher Botella	110 37 ^{3/16}	ø 5,2 x h 25,3 ø 2 ^{1/16} x h 9 ^{5/16}	6		236752 23,00

	cl - oz	cm - inch	MVM	CS	€
Carafe à jus de fruits Evento Juice/beverage carafe Botella para zumos	120 40 ^{9/16}	ø 10,5 x h 27,5 ø 4 ^{1/8} x h 10 ^{13/16}	1		202639 18,00
Bouchon de carafe silicone Evento Silicone stopper for carafe Tapón para botella silicona		ø 6,5 ø 2 ^{9/16}	1		202855 7,60
Carafe Empiléó Pitcher Botella	74 25 ^{3/8}	ø 9,1 x h 24 ø 3 ^{9/16} x h 4 ^{3/8}	1		234148 14,80
Carafe Empiléó bleue Blue Pitcher Botella azul	74 25 ^{3/8}	ø 9,1 x h 24 ø 3 ^{9/16} x h 4 ^{3/8}	1		236288 17,40



169728



188969



210904



199027



236752
NEW



202639



234148



236288
NEW



202855

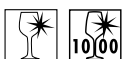

Cosmopolitain

	cl - oz	cm - inch	MVM	CS	€
Gobelet bas Low tumbler Vaso bajo	32 10 ^{13/16}	ø 8 x h 9,4 ø 3 ^{1/8} x h 3 ^{11/16}	6		184586 4,45
Gobelet bas Low tumbler Vaso bajo	42 14 ^{3/16}	ø 8,5 x h 10,6 ø 3 ^{3/8} x h 4 ^{3/16}	6		189774 4,75

	cl - oz	cm - inch	MVM	CS	€
Gobelet haut High tumbler Vaso alto	29 9 ^{13/16}	ø 7 x h 10,7 ø 2 ^{3/4} x h 4 ^{3/16}	6		184588 4,20
Gobelet haut High tumbler Vaso alto	35 11 ^{13/16}	ø 6,5 x h 14,4 ø 2 ^{9/16} x h 5 ^{11/16}	6		184589 4,45



Dandy



	cl - oz	cm - inch	MVM	CS	€		cl - oz	cm - inch	MVM	CS	€		
Flûte à champagne Champagne flute Flauta champagne	27 9 ^{1/8}	ø 8 x h 24,3 ø 3 ^{1/8} x h 9 ^{5/16}	6		184584	6,90	Verre à vin rouge Red wine glass Copa de vino tinto	42 14 ^{3/16}	ø 8,3 x h 23,1 ø 3 ^{1/4} x h 9 ^{1/8}	6		184582	7,00
Verre à vin blanc White wine glass Copa de vino blanco	35 11 ^{13/16}	ø 8 x h 22,3 ø 3 ^{1/8} x h 8 ^{3/4}	6		184583	6,90	Verre à eau Water glass Copa de agua	48 16 ^{1/4}	ø 8,9 x h 23,5 ø 3 ^{1/2} x h 9 ^{1/4}	6		184581	7,00

Dolce



	cl - oz	cm - inch	MVM	CS	€		cl - oz	cm - inch	MVM	CS	€		
Gobelet bas transparent Transparent low tumbler Vaso bajo transparent	43 14 ^{9/16}	ø 6,1 x h 10 ø 2 ^{3/8} x h 3 ^{15/16}	6	12	169852	5,60	Gobelet bas gris Gris low tumbler Vaso bajo gris	43 14 ^{9/16}	ø 6,1 x h 10 ø 2 ^{3/8} x h 3 ^{15/16}	6	12	169856	6,00
Gobelet haut transparent Transparent high tumbler Vaso alto transparent	57 19 ^{1/4}	ø 6,7 x h 11,5 ø 2 ^{5/8} x h 4 ^{1/2}	6	12	169851	6,00							

Domaine



	cl - oz	cm - inch	MVM	CS	€		cl - oz	cm - inch	MVM	CS	€		
Flûte à champagne Champagne flute Flauta champagne	19 6 ^{7/16}	ø 5,3 x h 21,9 ø 2 ^{1/16} x h 8 ^{5/8}	6		184566	5,50	Verre à eau Water glass Copa de agua	49,5 16 ^{3/4}	ø 8,6 x h 22,7 ø 3 ^{3/8} x h 8 ^{15/16}	6		184561	5,85
Verre à vin blanc White wine glass Copa de vino blanco	28 9 ^{7/16}	ø 7,3 x h 21,2 ø 2 ^{7/8} x h 8 ^{3/8}	6		184563	5,50	Verre à Bordeaux Bordeaux glass Copa de cava	65 22	ø 9,4 x h 23,9 ø 3 ^{1/16} x h 9 ^{7/16}	6		184564	5,85
Verre à vin rouge Red wine glass Copa de vino tinto	37 12 ^{1/2}	ø 7,7 x h 21,4 ø 3 ^{1/16} x h 8 ^{7/16}	6		184562	5,85	Verre à Bourgogne Burgundy glass Vaso Bourgogne	75 25 ^{3/8}	ø 10,7 x h 22,5 ø 4 ^{1/16} x h 8 ^{7/8}	6		184565	5,85

Empiléó



	cl - oz	cm - inch	MVM	CS	€	NEW		cl - oz	cm - inch	MVM	CS	€	
Gobelet Tumbler Vaso	26 8 ^{3/4}	ø 7,1 x h 9,1 ø 2 ^{13/16} x h 3 ^{5/16}	6		234150	5,50	Bleu - Blue - Azul	26 8 ^{3/4}	ø 7,1 x h 9,1 ø 2 ^{13/16} x h 3 ^{5/16}	6		236289	6,50
Verre à tapas Tapas glass Vaso de tapas	17 5 ^{3/4}	ø 7,9 x h 6,3 ø 3 ^{1/8} x h 2 ^{1/2}	6		234151	4,70	Verre à pied Stemmed glass Copa	26 8 ^{3/4}	ø 7,9 x h 11,1 ø 3 ^{1/8} x h 4 ^{3/8}	6		236287	6,95
Verre à pied Stemmed glass Copa	26 8 ^{3/4}	ø 7,9 x h 11,1 ø 3 ^{1/8} x h 4 ^{3/8}	6		234149	5,75							

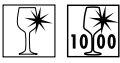

Galatée

	cl - oz	cm - inch	MVM	CS	€		cl - oz	cm - inch	MVM	CS	€		
Flûte à champagne Champagne flute Flauta champagne	20 6 ^{3/4}	ø 6,7 x h 21,2 ø 2 ^{5/8} x h 8 ^{3/8}	6		184556	6,50	Verre à eau Water glass Copa de agua	45 15 ^{3/16}	ø 8,4 x h 20,5 ø 3 ^{5/8} x h 8 ^{1/8}	6		190536	7,25
Verre à vin Wine glass Copa de vino	35 11 ^{13/16}	ø 7,8 x h 19,6 ø 3 ^{1/8} x h 7 ^{11/16}	6		190537	7,00	Gobelet Tumbler Vaso	47 15 ^{7/8}	ø 8,5 x h 12,1 ø 3 ^{3/8} x h 4 ^{3/4}	6		190538	5,85



NEW Héritage

	cl - oz	cm - inch	MVM	CS	€		cl - oz	cm - inch	MVM	CS	€		
Flûte à Champagne Champagne flute Flauta Champagne	13 4 ^{3/8}	ø 5 x h 21,7 ø 1 ^{15/16} x h 8 ^{9/16}	6		234102	7,15	Verre à eau Water glass Copa de agua	25 8 ^{7/16}	ø 7,3 x h 12 ø 2 ^{7/8} x h 4 ^{3/4}	6		234105	7,15
Verre à vin rouge Red wine glass Copa de vino tinto	40 13 ^{1/2}	ø 8,3 x h 21,7 ø 3 ^{1/4} x h 8 ^{9/16}	6		234103	7,15	Gobelet Tumbler Vaso	33 11 ^{3/16}	ø 7,9 x h 9,5 ø 3 ^{1/8} x h 3 ^{3/4}	6		234106	7,15
Verre à vin blanc White wine glass Copa de vino blanco	25 8 ^{7/16}	ø 7 x h 20 ø 2 ^{3/4} x h 8 ^{1/4}	6		234104	7,15							

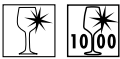

Hypnotic jaugé

	cl - oz	cm - inch	MVM	CS	€	
Verre à vin avec double jauge Red wine glass with 2 gauge Copa de vino tinto con doble indicador	36,5 13	ø 8,2 x h 22 ø 3 ^{1/4} x h 8 ^{11/16}	6		213816	6,15



Loop

	cl - oz	cm - inch	MVM	CS	€		cl - oz	cm - inch	MVM	CS	€		
Gobelet bas/verrine Low tumbler/appetizer glass Vaso bajo/vasitos	19 6 ^{7/16}	ø 6,7 x h 8,1 ø 2 ^{5/8} x h 3 ^{3/8}	6		184598	3,50	Gobelet haut High tumbler Vaso alto	39 13 ^{3/16}	ø 6,6 x h 14,5 ø 2 ^{5/8} x h 5 ^{11/16}	6		184601	4,10
Gobelet bas Low tumbler Vaso bajo	35 11 ^{13/16}	ø 7,9 x h 9,1 ø 3 ^{1/8} x h 3 ^{9/16}	6		184600	4,10							



Mambo



	cl - oz	cm - inch	MVM	CS	€		cl - oz	cm - inch	MVM	CS	€		
Gobelet gris Grey tumbler Vaso gris	34 11 ^{1/2}	ø 8,5 x h 10 ø 3 ^{3/8} x h 3 ^{15/16}	6	12	171631	6,20	Gobelet violet Purple tumbler Vaso violeta	34 11 ^{1/2}	ø 8,5 x h 10 ø 3 ^{3/8} x h 3 ^{15/16}	6	12	171633	6,20
Gobelet vert Green tumbler Vaso verde	34 11 ^{1/2}	ø 8,5 x h 10 ø 3 ^{3/8} x h 3 ^{15/16}	6	12	171632	6,20	Gobelet rouge Red tumbler Vaso rojo	34 11 ^{1/2}	ø 8,5 x h 10 ø 3 ^{3/8} x h 3 ^{15/16}	6	12	171630	7,50

Montmartre



	cl - oz	cm - inch	MVM	CS	€		cl - oz	cm - inch	MVM	CS	€		
Flûte à champagne Champagne flute Flauta champagne	21 7 ^{1/8}	ø 7 x h 21 ø 2 ^{3/4} x h 8 ^{1/4}	6		184580	4,15	Verre à vin rouge Red wine glass Copa de vino tinto	32 10 ^{13/16}	ø 7,8 x h 19,8 ø 3 ^{1/8} x h 7 ^{13/16}	6		184576	4,15
Verre à vin Wine glass Copa de vino	20 6 ^{3/4}	ø 7 x h 17,4 ø 2 ^{3/4} x h 6 ^{7/8}	6		184578	3,90	Verre à eau Water glass Copa de agua	42 14 ^{3/16}	ø 8,7 x h 20,5 ø 3 ^{7/8} x h 8 ^{1/8}	6		184575	4,55
Verre à vin blanc White wine glass Copa de vino blanco	25 8 ^{7/16}	ø 7,5 x h 18,4 ø 2 ^{15/16} x h 7 ^{1/4}	6		184577	3,90	Verre à Bourgogne Burgundy glass Copa Bourgogne	58 19 ^{5/8}	ø 10 x h 20 ø 3 ^{15/16} x h 7 ^{7/8}	6		184579	5,15

	cl - oz	cm - inch	MVM	CS	€	
Verre à vin rouge avec double jauge 12,5/14 cl Red wine glass with 2 gauge 12,5/14 cl Copa de vino tinto con doble indicador de nivel 12,5/14 cl	32 10 ^{13/16}	ø 7,8 x h 19,8 ø 3 ^{1/8} x h 7 ^{13/16}	6		208481	4,95

Muse



	cl - oz	cm - inch	MVM	CS	€		cl - oz	cm - inch	MVM	CS	€		
Flûte à champagne Champagne flute Flauta champagne	19 6 ^{7/16}	ø 6,3 x h 22,4 ø 2 ^{1/2} x h 8 ^{13/16}	6		184551	6,50	Verre à eau Water glass Copa de agua	45 15 ^{3/16}	ø 8,4 x h 22,5 ø 3 ^{5/16} x h 8 ^{1/8}	6		184547	6,95
Verre à vin blanc White wine glass Copa de vino blanco	28 9 ^{7/16}	ø 7,4 x h 20,8 ø 2 ^{15/16} x h 8 ^{3/8}	6		184549	6,50	Verre à Bordeaux Bordeaux glass Copa de cava	64,5 21 ^{13/16}	ø 9,5 x h 23,8 ø 3 ^{3/4} x h 9 ^{3/8}	6		184550	6,95
Verre à vin rouge Red wine glass Copa de vino tinto	35 11 ^{13/16}	ø 8 x h 21,4 ø 3 ^{1/8} x h 8 ^{7/16}	6		184548	6,95	Verre à Bourgogne Burgundy glass Copa Bourgogne	70 23 ^{11/16}	ø 10,5 x h 23,1 ø 4 ^{1/8} x h 9 ^{1/8}	6		210812	6,95

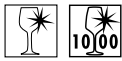

Muse



	cl - oz	cm - inch	MVM	CS	€		cl - oz	cm - inch	MVM	CS	€		
Gobelet bas/verrine Low tumbler/appetizer glass Vaso bajo/vasitos	15 5 ^{1/16}	ø 6,4 x h 8 ø 2 ^{1/2} x h 3 ^{1/8}	6		184552	4,85	Gobelet bas Low tumbler Vaso bajo	33 11 ^{3/16}	ø 8 x h 10,2 ø 3 ^{1/8} x h 4	6		184554	5,55
Gobelet bas Low tumbler Vaso bajo	23 7 ^{3/4}	ø 7,6 x h 9,2 ø 3 x h 3 ^{5/8}	6		184553	5,20	Gobelet haut High tumbler Vaso alto	36 12 ^{3/16}	ø 6,8 x h 14,2 ø 2 ^{11/16} x h 5 ^{9/16}	6		184555	5,55



NEW Roc

	cl - oz	cm - inch	MVM	CS	€		cl - oz	cm - inch	MVM	CS	€		
Gobelet bas Low tumbler Vaso bajo	18 6 ^{1/16}	ø 7,2 x h 6,5 ø 2 ^{13/16} x h 2 ^{9/16}	6		236338	6,00	Verre à pied stemmed glass Copa	27 9 ^{1/8}	ø 7,2 x h 11,5 ø 2 ^{13/16} x h 4 ^{1/2}	6		236340	7,50
Gobelet haut High tumbler Vaso alto	45 15 ^{3/16}	ø 7,2 x h 14 ø 2 ^{13/16} x h 5 ^{1/2}	6		236339	7,00							



Origine

	cl - oz	cm - inch	MVM	CS	€	
Verre N°1 - Effervescence Glass N°1 - Effervescence Copa N°1 - Espuma	22,5 7 ^{5/8}	ø 7,1 x h 21 ø 2 ^{13/16} x h 8 ^{1/4}	6		216733	5,50
Verre N°2 - Fraîcheur Glass N°2 - Freshness Copa N°2 - Frescura	50 16 ^{15/16}	ø 8,9 x h 21,5 ø 3 ^{1/2} x h 8 ^{7/16}	6		216730	5,85
Verre N°3 - Puissance Glass N°3 - Strength Copa N°3 - Potencia	50 16 ^{15/16}	ø 9,5 x h 21,5 ø 3 ^{3/4} x h 8 ^{7/16}	6		216731	5,85
Verre N°4 - Subtilité Glass N°4 - Subtlety Copa N°4 - Sutilez	60 20 ^{5/16}	ø 10,2 x h 21,5 ø 4 x h 8 ^{7/16}	6		216732	5,85
Verre N°5 - Douceur Glass N°5 - Sweetness Copa N°5 - Dulzor	20 6 ^{3/4}	ø 6,9 x h 20 ø 2 ^{11/16} x h 7 ^{7/8}	6		216734	5,35



Oslo

	cl - oz	cm - inch	MVM	CS	€	
Bol sablé Frosted bowl Copa/vasito	30 10 ^{1/8}		6		210811	8,50



ROUGE PLUS

Vi EQUIPEMENT

160 Avenue Paul Vaillant Couturier

93120 LA COURNEUVE

tel.: +33 (0)1 75 43 77 96

fax: +33 (0)1 75 43 77 97

site web: www.rougeplus.com

email: contact@rougeplus.com